



**Quonset Microwave**  
www.quonsetmicrowave.com

---

**QM1003-0.5-18-1-100-205**  
**Single Channel RF Downconverter**

Option 100: Internal LOs  
Option 205: 2-3 GHz IF BW

**User Manual**

Revision 3.0.0, September 2023

---

## Notices

© 2017-2023 Quonset Microwave

No part of this manual may be reproduced in any form or by any means (including electronic storage and retrieval or translation into a foreign language) without prior permission and written consent from Quonset Microwave as governed by United States and international copyright laws.

### Manual Part Number

1003-004-21

### Edition

Revision 3.0.0, September 2023

Printed in the USA

Quonset Microwave

315 Commerce Park Road

Unit 3

North Kingstown, RI 02852 USA

### Warranty

The material contained in this document is provided "as is," and is subject to be changed, without notice, in future editions. Further, to the maximum extent permitted by applicable law, Quonset Microwave disclaims all warranties, either expressed or implied, with regard to this manual and any information contained herein, including but not limited to the implied warranties of merchantability and fitness for a particular purpose. Quonset Microwave shall not be liable for errors or incidental or consequential damages in connection with the furnishing, use, or performance of this document or of any information contained herein. Should Quonset Microwave and the user have a separate written agreement with warranty terms covering the material in this document that conflict with these terms, the warranty terms in the separate agreement shall control.

### Technology Licenses

The hardware and/or software described in this document are furnished under a license and may be used or copied only in accordance with the terms of such license.

### Restricted Rights Legend

U.S. Government Restricted Rights. Software and technical data rights granted to the federal government include only those rights customarily provided to end user customers.

Quonset Microwave provides this customary commercial license in Software and technical data pursuant to FAR 12.211 (Technical Data) and 12.212 (Computer Software) and, for the Department of Defense, DFARS 252.227-7015 (Technical Data - Commercial Items) and DFARS 227.7202-3 (Rights in Commercial Computer Software or Computer Software Documentation).

### Safety Notices

---

#### CAUTION

A **CAUTION** notice denotes a hazard. It calls attention to an operating procedure, practice, or the like that, if not correctly performed or adhered to, could result in damage to the product or loss of data. Do not proceed beyond a **CAUTION** notice until the indicated conditions are fully understood and met.

---

#### WARNING

A **WARNING** notice denotes a hazard. It calls attention to an operating procedure, practice, or the like that, if not correctly performed or adhered to, could result in personal injury or death. Do not proceed beyond a **WARNING** notice until the indicated conditions are fully understood and met.

---

## Restricted Rights Legend

The Software and Documentation have been developed entirely at private expense. They are delivered and licensed as "commercial computer software" as defined in DFARS 252.227-7013 (Oct 1988), DFARS 252.211-7015 (May 1991), or DFARS 252.227-7014 (Jun 1995), as a "commercial item" as defined in FAR 2.101(a) or as "restricted computer software" as defined in FAR 25.227-19 (Jun 1987) (or any equivalent agency regulation or contract clause), whichever is applicable. The End User has only those rights provided for such Software and Documentation by the applicable FAR or DFARS clause or the Quonset Microwave standard software agreement for the product involved.

## General Warranty

The material contained in this document is provided "as is," and is subjected to being changed, without notice, in future editions. Further, to the maximum extent permitted by applicable law, Quonset Microwave disclaims all warranties, either expressed or implied with regard to this manual and any information contained herein, including but not limited to the implied warranties of merchantability and fitness for a particular purpose. Quonset Microwave shall not be liable for errors or for incidental or consequential damages in connection with the furnishing, use, or performance of this document or any information contained herein. Should Quonset Microwave and the user have a separate written agreement with warranty terms covering the material in this document that conflict with these terms, the warranty terms in the separate agreement shall control. Duration and conditions of warranty for this product may be superseded when the product is integrated into (becomes part of) other Quonset Microwave products. During the warranty period, Quonset Microwave will, at its option, either repair or replace products which prove to be defective. The warranty period begins on the date of delivery or on the date of installation if installed by Quonset Microwave.

## Product Safety

The following general safety precautions must be observed during all phases of operation of this device. Failure to comply with these precautions or with specific warnings elsewhere in this manual violates safety standards of design, manufacture, and intended use of this device. Quonset Microwave assumes no liability for the customer's failure to comply with these requirements.

## Safety Notices

---

### CAUTION

A **CAUTION** notice denotes a hazard. It calls attention to an operating procedure, practice, or the like that, if not correctly performed or adhered to, could result in damage to the product or loss of data. Do not proceed beyond a **CAUTION** notice until the indicated conditions are fully understood and met.

---

### WARNING

A **WARNING** notice denotes a hazard. It calls attention to an operating procedure, practice, or the likes that, if not correctly performed or adhered to, could result in personal injury or death. Do not proceed beyond a **WARNING** notice until the indicated conditions are fully understood and met.

---

### Personal Safety Considerations

This is a Safety Class I product (provided with a protective earthing ground incorporated in the power cord). The mains plug shall only be inserted in a socket outlet provided with a protective earth contact. Any interruption of the protective conductor, inside or outside the product, is likely to make the product dangerous. Intentional interruption is prohibited. If this product is not used as specified, the protection provided by the equipment could be impaired. This product must be used in a normal condition (in which all means of protection are intact) only.

No operator serviceable parts inside. Refer servicing to qualified personnel. To prevent electrical shock, do not remove covers. For continued protection against fire hazard, replace the line fuse(s) only with fuses of the same type and rating (for example, normal blow, time delay, etc.). The use of other fuses or material is prohibited.

### General Safety Information

The following general safety precautions must be observed during all phases of operation of this product. Failure to comply with these precautions or with specific warnings elsewhere in this manual or any manual associated with this product violates safety standards of design, manufacture, and intended use of the product. Quonset Microwave assumes no liability for the customer's failure to comply with these requirements.

---

## WARNING

**BEFORE APPLYING POWER TO THIS PRODUCT OR MAKING ANY CONNECTIONS TO THIS PRODUCT ensure that all instruments are connected to the protective (earth) ground. Any interruption of the protective earth grounding will cause a potential shock hazard that could result in personal injury or death.**

---

## CAUTION

- Use this device with the cables provided.
  - Do not attempt to service this device. This device should be returned to Quonset Microwave for any service or repairs.
  - Do not open the device.
- 

### User Environment

**This instrument is designed for *indoor* use only.**

## Markings

The following markings may appear on the equipment or in any related documentation.



This marking indicates that a device, or part of a device, may be susceptible to electrostatic discharges (ESD) which can result in damage to the product. Observed ESD precautions given on the product, or in its user documentation, when handling equipment bearing this mark.



This marking indicates that the device complies with applicable sections of part 15 of the FCC rules.



This marking indicates that the device conforms with applicable EC directives.



This marking indicates that the device complies with the Virtual Instrument Software Architecture (VISA) specification.



This marking indicates that the device complies with the Standard Commands for Programmable Instrumentation (SCPI) specification.



This marking indicates that the device complies with the USB Test & Measurement Class (USB TMC) and the USB 488 subclass specifications.



This marking indicates that the device communicates over the Universal Serial Bus (USB).



This marking indicates that the device communicates over Ethernet.

# Revision Control

<b>Revision</b>	<b>Description of Changes</b>	<b>Date</b>
1.0.0	Initial Release	07/21/2022
1.1.0	Changed to single channel to differentiate between this and dual channel manual	03/10/2023
1.2.0	Made specific to QM1003-0.5-18-1-100-205	05/23/2023
2.0.0	R01 hardware update information Firmware Updates Additions	07/17/2023
3.0.0	R03 hardware update information R00 cleanup (obsolete) and R02 update Fixed typo in SYST:READ	09/15/2023



# Contents

Notices . . . . .	i
Manual Part Number . . . . .	i
Edition . . . . .	i
Warranty . . . . .	i
Technology Licenses . . . . .	i
Restricted Rights Legend . . . . .	i
Safety Notices . . . . .	i
Restricted Rights Legend . . . . .	ii
General Warranty . . . . .	ii
Product Safety . . . . .	ii
Safety Notices . . . . .	ii
Personal Safety Considerations . . . . .	iii
General Safety Information . . . . .	iii
User Environment . . . . .	iii
Markings . . . . .	iv
Revision Control . . . . .	v
<b>1 Overview</b>	<b>2</b>
1. Input/Output Specifications . . . . .	3
2. General Description . . . . .	4
3. System Block Diagram . . . . .	5
<b>2 Firmware Updates</b>	<b>6</b>
1. Introduction . . . . .	7
2. Firmware Update Files . . . . .	7
3. FPGA Firmware Updates . . . . .	8
4. PIC Firmware Updates . . . . .	16
<b>3 Remote Operation</b>	<b>17</b>
1. Introduction . . . . .	19
1.1 USB Configuration . . . . .	19
1.2 Command Syntax . . . . .	19
1.2.1 Mnemonic Forms . . . . .	19
1.2.2 Using a Semicolon(;) . . . . .	19
1.2.3 Using Whitespace . . . . .	19
1.2.4 Using "?" Commands . . . . .	19
1.2.5 Using "*" Commands . . . . .	19
1.3 Diagram Syntax Conventions . . . . .	19
1.4 Default Units . . . . .	20
1.5 Status Reporting . . . . .	20



1.6	SCPI Data Types . . . . .	20
1.6.1	<boolean> Definition . . . . .	20
1.6.2	<character_data> Definition . . . . .	21
1.6.3	<NAN> Definition . . . . .	21
1.6.4	<non-decimal numeric> Definition . . . . .	21
1.6.5	<NRf> Definition . . . . .	21
1.6.6	<NR1> Definition . . . . .	21
1.6.7	<NR2> Definition . . . . .	21
1.6.8	<NR3> Definition . . . . .	22
1.6.9	<numeric_value> Definition . . . . .	22
1.6.10	<string> Definition . . . . .	22
1.7	Input Message Terminators . . . . .	23
1.8	Compliance Information . . . . .	23
1.8.1	IEEE-488.2 Compliance . . . . .	23
1.8.2	USBTMC Compliance . . . . .	23
1.8.3	VISA Compliance . . . . .	24
2.	VISA Descriptors and Configuration . . . . .	25
2.1	USBTMC . . . . .	25
2.1.1	VISA Descriptors . . . . .	25
2.1.2	USBTMC VISA Code Example . . . . .	25
<b>4</b>	<b>Control Commands</b>	<b>26</b>
1.	Command Quick Reference Guide . . . . .	28
1.1	Common (*) Commands . . . . .	28
1.2	FREQuency Subsystem . . . . .	29
1.3	POWER Subsystem . . . . .	29
1.4	STATus Subsystem . . . . .	30
1.5	SYSTEM Subsystem . . . . .	30
2.	FREQuency Subsystem Command Reference . . . . .	31
2.1	FREQuency:ASR . . . . .	31
2.2	FREQuency:LOCK . . . . .	32
2.3	FREQuency:MODE . . . . .	33
2.4	FREQuency:TUNE . . . . .	34
2.5	FREQuency:TUNErACTual . . . . .	35
2.6	FREQuency:LO1:EXTernal . . . . .	36
2.7	FREQuency:LO1:LOCK . . . . .	37
2.8	FREQuency:LO2:EXTernal . . . . .	38
2.9	FREQuency:LO2:LOCK . . . . .	39
2.10	FREQuency:REFerence:EXTernal . . . . .	40
3.	POWER Subsystem Command Reference . . . . .	41
3.1	POWER:AT1 . . . . .	41
3.2	POWER:AT2 . . . . .	42
3.3	POWER:RF . . . . .	43
4.	STATus Subsystem Command Reference . . . . .	44
4.1	STATus:OPERation . . . . .	44
4.2	STATus:OPERation:CONDition . . . . .	45

4.3	STATus:OPERation:ENABLE	46
4.4	STATus:PRESet	47
4.5	STATus:QUEStionable	48
4.6	STATus:QUEStionable:CONDition	49
4.7	STATus:QUEStionable:ENABLE	50
5.	SYSTem Subsystem Command Reference	51
5.1	SYSTem:BOOTstate	51
5.2	SYSTem:CURRent	52
5.3	SYSTem:ERRor	53
5.4	SYSTem:FIRMWare	57
5.5	SYSTem:LOADstate	58
5.6	SYSTem:OPTions	59
5.7	SYSTem:READstate	60
5.8	SYSTem:SAVEstate	61
5.9	SYSTem:SERialNUMBER	62
5.10	SYSTem:USBPID	63
5.11	SYSTem:VERSIon	64
6.	IEEE 488.2 Command Reference	65
6.1	Introduction	65
6.2	*CLS	66
6.3	*ESE <NRf>	67
6.4	*ESR?	68
6.5	*IDN?	69
6.6	*OPC	70
6.7	*RCL <NRf>	71
6.8	*RST	72
6.9	*SAV <NRf>	73
6.10	*SDS <NRf>	74
6.11	*SRE <NRf>	75
6.12	*STB?	76
6.13	*TST?	77
6.14	*WAI	78
<b>5</b>	<b>Windows Control GUI</b>	<b>79</b>
1.	Overview	80
	<b>Index</b>	<b>81</b>

# List of Tables

1.1	Input/Output Specifications . . . . .	3
2.1	PIC Firmware Revision History . . . . .	7
3.2	Default Units . . . . .	20
4.1	Common (*) Commands Summary . . . . .	28
4.2	FREQuency Subsystem Commands Summary . . . . .	29
4.3	POWEr Subsystem Commands Summary . . . . .	29
4.4	STATus Subsystem Commands Summary . . . . .	30
4.5	SYSTem Subsystem Commands Summary . . . . .	30
4.6	Converter Operation Modes . . . . .	33
4.7	Error Codes and Messages . . . . .	53
4.8	IEEE 488.2 Common commands . . . . .	65
4.9	*ESE bit mapping . . . . .	67
4.10	*ESR? mapping . . . . .	68
4.11	*OPC mapping . . . . .	70
4.12	*SRE bit mapping . . . . .	75
4.13	*STB? mapping . . . . .	76

# List of Figures

1.1	QM1003-0.5-18-1-100-205 Single Channel RF Downconverter system . . . . .	4
1.2	QM1003-0.5–18-1 Downconverter Block Diagram . . . . .	5
2.1	iMPACT: Automatically create project . . . . .	10
2.2	iMPACT: Manually Create Project . . . . .	10
2.3	iMPACT: Boundary Scan . . . . .	11
2.4	iMPACT: Assign Configuration Files . . . . .	11
2.5	iMPACT: Attach PROM . . . . .	12
2.6	iMPACT: Configure PROM . . . . .	12
2.7	iMPACT: FPGA Programming Properties . . . . .	13
2.8	iMPACT: FPGA Programming Properties . . . . .	13
2.9	iMPACT: FLASH Programming Properties . . . . .	14
2.10	iMPACT: Programming . . . . .	14
2.11	iMPACT: Program Succeeded . . . . .	15
2.12	CCSLOAD: PIC Programming . . . . .	16
5.1	Windows® Control GUI . . . . .	80



# 1 Overview

## In This Chapter

1. Input/Output Specifications . . . . .	3
2. General Description . . . . .	4
3. System Block Diagram . . . . .	5

## 1. Input/Output Specifications

**Table 1.1:** Input/Output Specifications

Parameter	Min	Typ	Max	Unit
External 10 MHz Reference Input				
Frequency		10		MHz
Power Level		TBD		dBm
External LO1 Input				
Frequency	21.5		39	GHz
Power Level		TBD		dBm
External LO2 Input				
Frequency		23.5		GHz
Power Level		TBD		dBm
Downconverter RF Input				
Frequency	0.5		18	GHz
Power Level (absolute maximum)			TBD	dBm
LO1 Output				
Frequency	21.5		39	GHz
Power Level		TBD		dBm
LO2 Output				
Frequency		23.5		GHz
Power Level		TBD		dBm
10 MHz Reference Output				
Frequency		10		MHz
Power Level		TBD		dBm
Type: Sine Wave				
Downconverter IF Output @ 0 dB attenuation				
Frequency	2		3	GHz
Gain		TBD		dB
Maximum Output Power Level		TBD		dBm

## 2. General Description

The QM1003-0.5-18-1-100-205 is a Single Channel RF Downconverter housed in a 1U box. The QM1003-0.5-18-1-100-205 is controlled either through the onboard USB or TCP/IP connection. The QM1003-0.5-18-1-100-205 delivery kit contains a user manual, power supply, and USB A- $\mu$ B cable. A model of the QM1003-0.5-18-1-100-205 is shown below in Fig. 1.1.

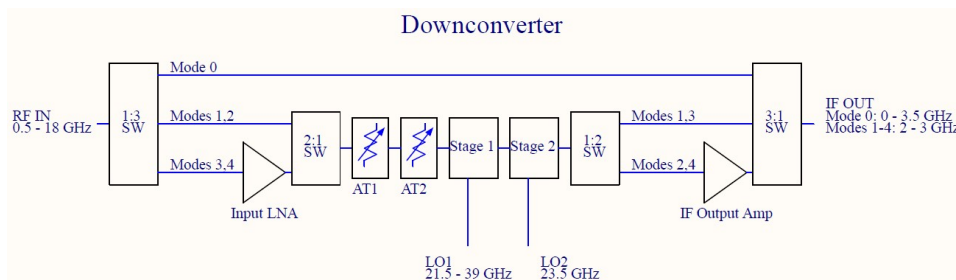

**Figure 1.1:** QM1003-0.5-18-1-100-205 Single Channel RF Downconverter system

The QM1003-0.5-18-1-100-205 Single Channel RF Downconverter has been equipped with Option -100, which adds Local Oscillator (LO) sources, making the QM1003-0.5-18-1-100-205 a self contained system, requiring only the externally applied RF or IF signals for proper operation. Option -205 shifts the IF frequency range from 750-1250MHz to 2-3GHz. The Local Oscillators (LOs) in the QM1003-0.5-18-1-100-205 are locked to a common internal reference. The user has the option of supplying their own reference through the BNC connector located on the back panel of the QM1003-0.5-18-1-100-205.

### 3. System Block Diagram

A system block diagram for the QM1003-0.5-18-1-100-205 Single Channel RF Downconverter is shown in Figure 1.2. An internal attenuator in the downconverter is controlled digitally via a microcontroller, which interfaces to a PC through USB or TCP/IP. The microcontroller outputs basic status messages on a 32-character Liquid Crystal Display (LCD) mounted on the faceplate of the unit. An internal 10 MHz reference is phase-locked to all of the internal LOs, with a BNC-F connector providing the option for LOs to lock to a user-provided 10 MHz external reference. An additional BNC-F connector outputs a 10 MHz reference for use by external test equipment. Switching between the internal and external LO reference is controlled either by the microcontroller or a reference selector switch.



**Figure 1.2: QM1003-0.5-18-1 Downconverter Block Diagram**





# 2 Firmware Updates

## In This Chapter

1. Introduction . . . . .	7
2. Firmware Update Files . . . . .	7
3. FPGA Firmware Updates . . . . .	8
4. PIC Firmware Updates . . . . .	16

## 1. Introduction

The QM1003-0.5-18-1-100-205 Single Channel RF Downconverter is continually being improved and may require firmware updates to correct problems in previous firmware versions or to add new features that were not yet implemented in previous firmware versions. Table 2.1 details Firmware Revisions that have been released and which features they fixed or introduced.

**Table 2.1: PIC Firmware Revision History**

<b>PIC Firmware Version</b>	<b>Reason To Update</b>
v1.0.0	N/A (Initial release)
v2.0.0	Requires R01 hardware - Initial R01 release
v3.0.0	Requires R02 hardware - Initial R02 release
v3.1.0	Requires R03 hardware - Initial R03 release
<b>FPGA Firmware Version</b>	<b>Reason To Update</b>
v1.0.0	N/A (Initial release)
v2.0.0	Requires R01 hardware - Initial R01 release
v3.0.0	Requires R02 hardware - Initial R02 release
v3.1.0	Requires R03 hardware - Initial R03 release

## 2. Firmware Update Files

The required files to perform firmware updates are uploaded onto the Quonset Microwave FTP server and need to be downloaded and extracted to a location on the computer performing the update prior to continuing.

Firmware updates can be obtained by clicking the following link and navigating to the download link in the Software tab:

<http://www.quonsetmicrowave.com/QM1003-0.5-18-1-p/qm1003-0.5-18-1.htm>

The zip files contain the necessary files required to perform the firmware updates. PIC Firmware Updates require \*.hex files and FPGA Firmware Updates require both \*.bit files and \*.mcs files. If the firmware update zip file contains all three files, it is recommended to upgrade both PIC and FPGA firmware versions to ensure proper performance as they likely work together and require each other for correct interaction.

### 3. FPGA Firmware Updates

The QM1003-0.5-18-1-100-205 Control Board uses a Micron™ serial flash and a Xilinx® FPGA. Micron™ serial flash are not currently fully supported by the Xilinx® iMPACT programming tool. The following sections demonstrate the steps required to successfully configure the iMPACT software and load a Micron™ flash.

#### Xilinx® iMPACT

Xilinx® iMPACT Standalone Programmer is included in the Xilinx® ISE Lab Tools and is used in this guide. The version used in this manual (v14.7) is the last ISE version and should not change. ISE Lab Tools are available for free download using the following link:

[https://www.xilinx.com/member/forms/download/xef-ise.html?filename=Xilinx\\_LabTools\\_14.7\\_1015\\_1.tar](https://www.xilinx.com/member/forms/download/xef-ise.html?filename=Xilinx_LabTools_14.7_1015_1.tar)

**Note:** All Xilinx® software downloads require Name and Address Verification in compliance with U.S. Government Export Regulations prior to downloading.

#### Smart Heap

To run iMPACT on Windows 10, the following steps must be taken:

1. Navigate to the following Lab Tools install directory: <install\_path>\Xilinx\14.7\LabTools\LabTools\lib\nt64\  
LabTools\lib\nt64\
2. Rename the file "libPortability.dll" to "libPortability.dll.orig"
3. Copy the "libPortabilityNOSH.dll" file to the same folder, renaming it to "libPortability.dll"
4. Repeat steps 1-3 in the following folder: <install\_path>\Xilinx\14.7\Labtools\common\lib\nt64\  
nt64\

The above steps substitute the original "libPortability.dll" with a "libPortability.dll" file that has SmartHeap disabled, the NOSmartHeap (NOSH) version. This does not negatively impact the operation of the tools, and should successfully work around a known incompatibility in LabTools v14.7.

#### System Environment Variable

A system environment variable must be set to allow the iMPACT software to skip its ID Check of the Micron™ flash. In Microsoft Windows, this is done through System Properties. In Microsoft Windows 10, click the Start Button and type "Edit the system environment variables" and click on the "Environment Variables" button. The Environment Variables window is divided into two sections, User Variables and System Variables. A new System Environment Variable must be created by clicking "New" in the System Variables section. In the New System Variable window, enter the following:

Variable name: XIL\_IMPACT\_SKIPIDCODECHECK

Variable value: 1

**Digilent Plugin for Xilinx Tools**

The internal Digilent programmer requires a Digilent Plugin for Xilinx Tools to be installed in order to work properly with iMPACT. The current version of the plugin (v2.5.2) can be downloaded directly from:

[https://files.digilent.com/Software/Digilent\\_Plugin/libCseDigilent\\_2.5.2-x86-x64-Windows.zip](https://files.digilent.com/Software/Digilent_Plugin/libCseDigilent_2.5.2-x86-x64-Windows.zip)

This version may change in the future and the latest version should remain available on the Digilent website located at:

<https://digilent.com/reference/software/digilent-plugin-xilinx-tools/start>

After downloading and extracting the files, perform the following steps:

1. Copy the Digilent folder from: <extracted\_location>\libCseDigilent\_2.5.2-x86-x64-Windows\ISE14x\plugin\nt64\plugins\  
ISE14x\plugin\nt64\plugins\  
ISE14x\plugin\nt64\plugins\  
ISE14x\plugin\nt64\plugins\  
ISE14x\plugin\nt64\plugins\  
ISE14x\plugin\nt64\plugins\  
ISE14x\plugin\nt64\plugins\  
ISE14x\plugin\nt64\plugins\
2. Paste the Digilent folder into the LabTools installation in: <install\_path>\Xilinx\14.7\LabTools\  
LabTools\lib\nt64\plugins\  
LabTools\lib\nt64\plugins\  
LabTools\lib\nt64\plugins\  
LabTools\lib\nt64\plugins\  
LabTools\lib\nt64\plugins\  
LabTools\lib\nt64\plugins\  
LabTools\lib\nt64\plugins\  
LabTools\lib\nt64\plugins\

The above steps allow the iMPACT software to use the Digilent programmer within its environment and connect to the device.

**Adept 2 Runtime**

The internal Digilent programmer also requires the Adept 2 Runtime to be installed. The current version (v2.26.1) can be downloaded from:

<https://mautic.digilentinc.com/adept-system-download>

Only the Adept 2 Runtime is required and the Adept Application does not need to be installed.

**USB Cable Connection**

A standard USB 2.0 A-Male to B-Male Cable can be used to connect the computer to the QM1003-0.5-18-1-100-205. The A-Male end of the cable connects to the computer and the B-Male end of the cable connects to the QM1003-0.5-18-1-100-205 in the port on the back panel labeled FPGA PROG.

## Programming with iMPACT

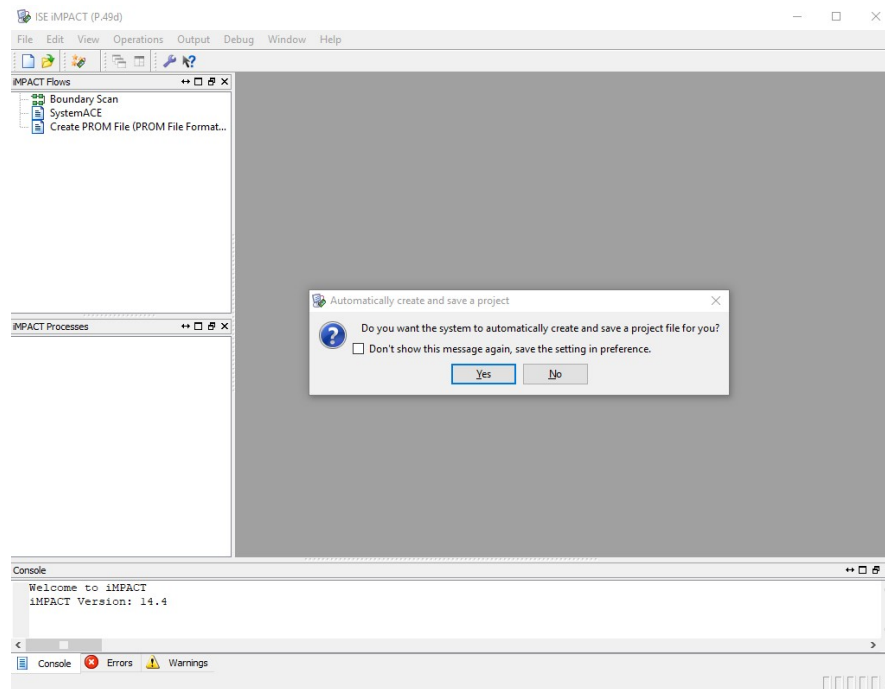

**Figure 2.1:** iMPACT: Automatically create project

When iMPACT is started, it will first ask if you want it to create and save a project file for you. Choose 'No', as reusing projects sometimes results in outdated files being programmed, which were saved in previous sessions.

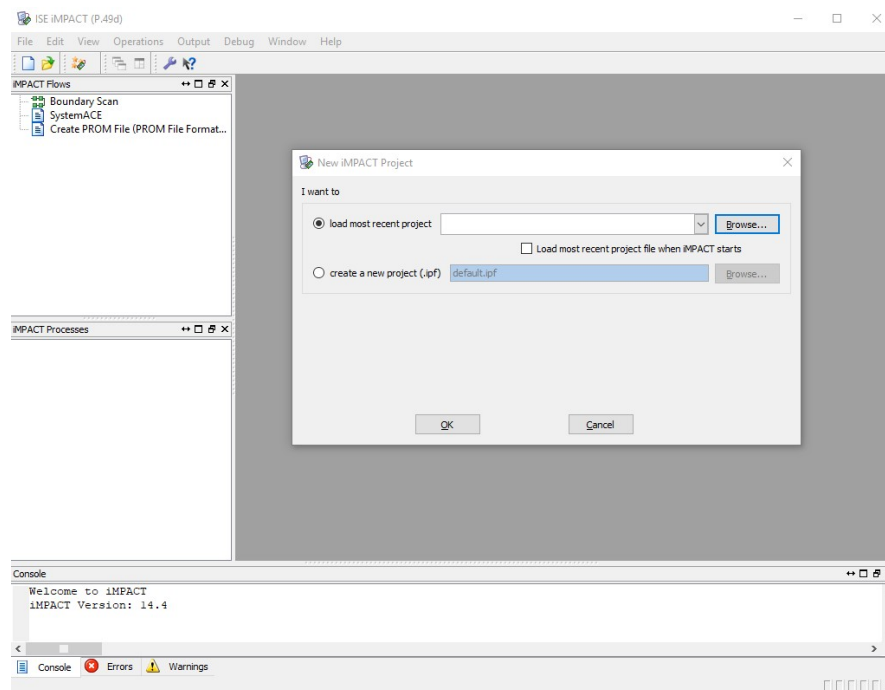

**Figure 2.2:** iMPACT: Manually Create Project

Similarly, select 'Cancel' when it asks you to load or create a new project next.

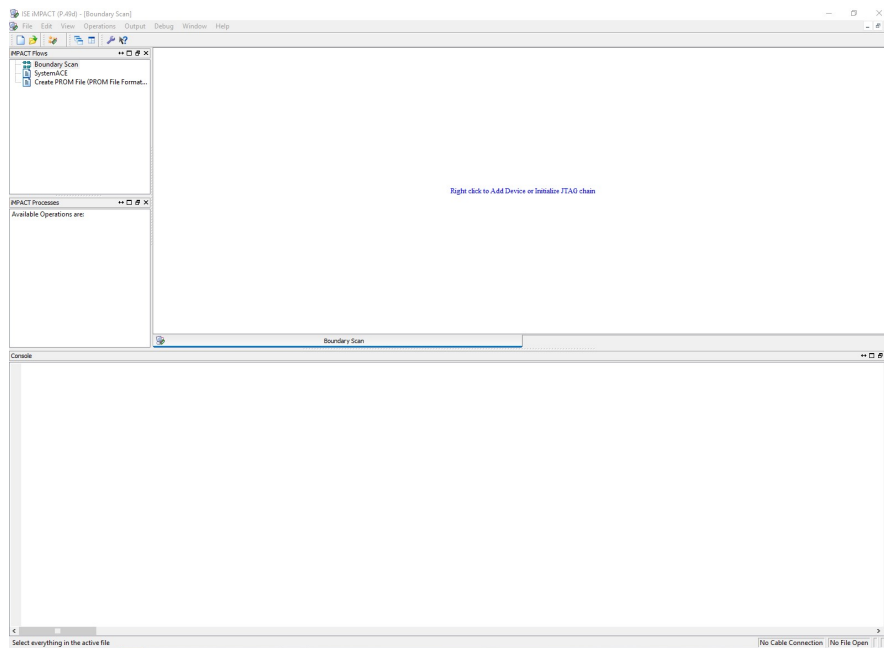

**Figure 2.3: iMPACT: Boundary Scan**

Double-click 'Boundary Scan' in the upper-left of the program. This will open a Boundary Scan window, which is where we interact with the device.

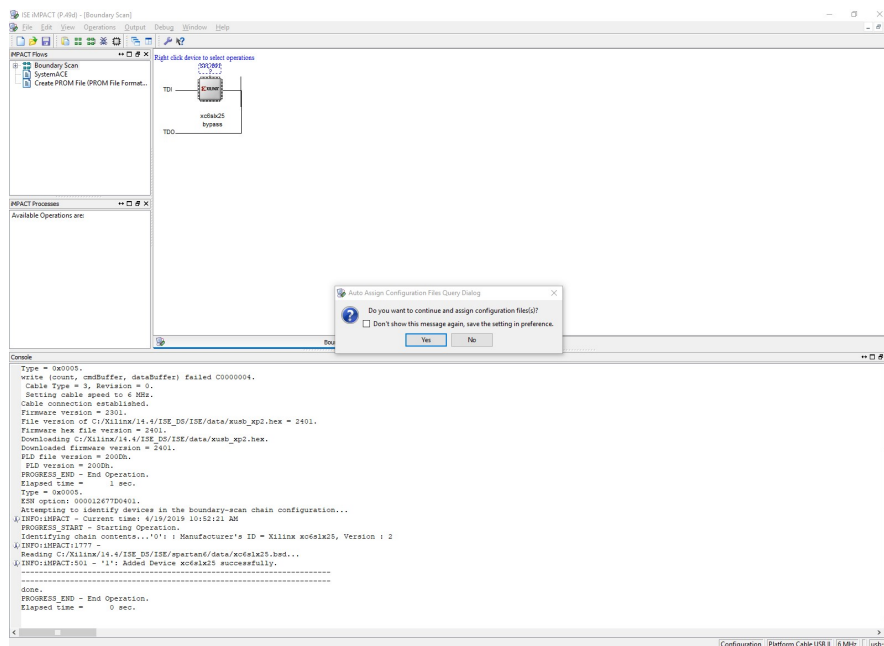

**Figure 2.4: iMPACT: Assign Configuration Files**

Right-click in the Boundary Scan window and select 'Initialize Chain', which will search for the target device. After the device is found, choose 'Yes' when it asks if you want to assign configuration files.

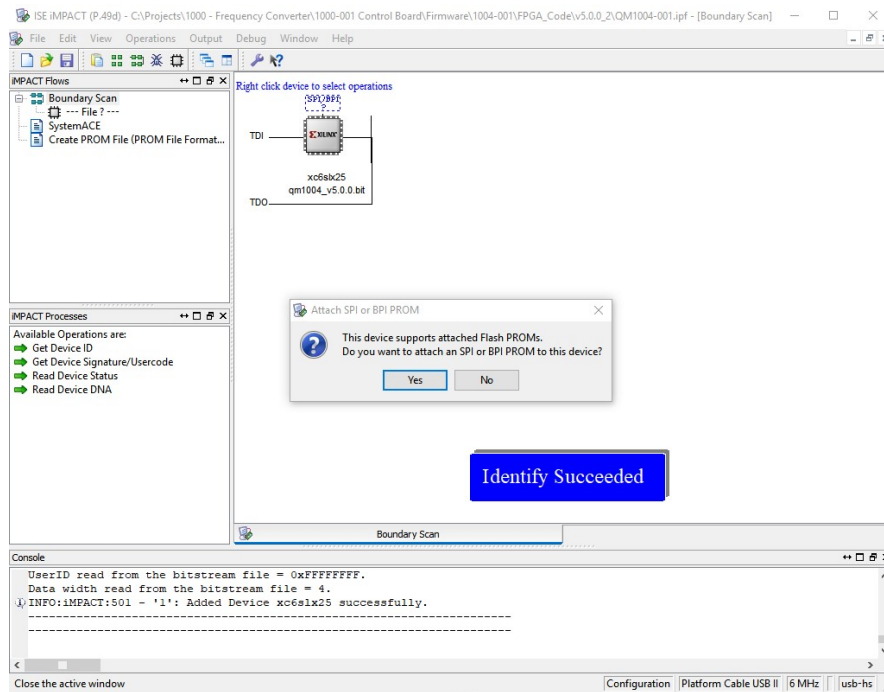

**Figure 2.5: iMPACT: Attach PROM**

Select the QM1003-0.5-18-1\_v1.0.0.bit file provided and the text under the device will change from 'Bypass' to qm1003-0.5-18\_v1.0.0.bit and it will ask if you want to attach a PROM. Choose 'Yes'.

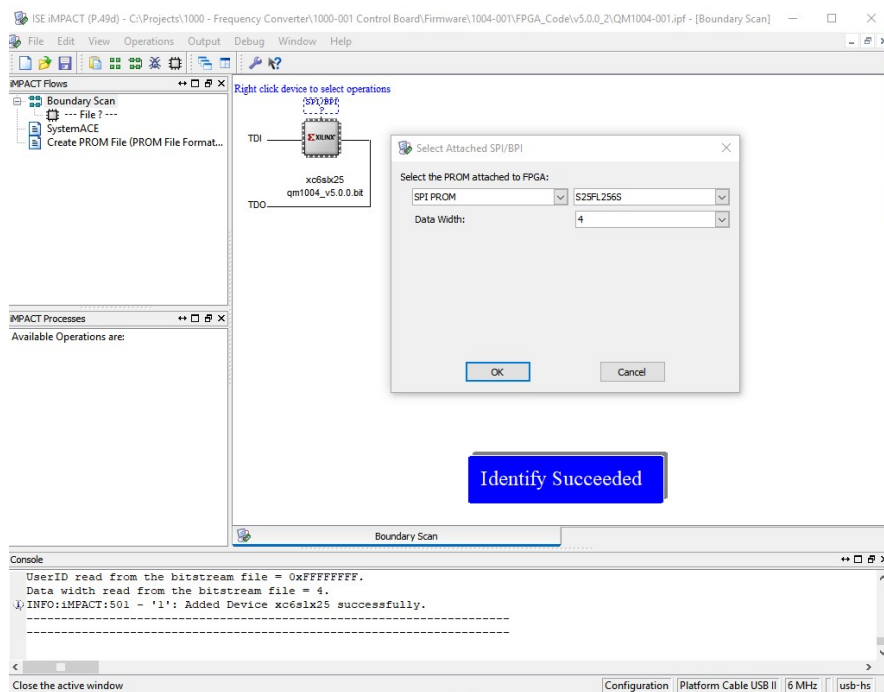

**Figure 2.6: iMPACT: Configure PROM**

Select the QM1003-0.5-18\_v1.0.0.mcs file provided and it will ask you to configure the PROM. Select 'S25FL256S' for the device and '4' for the data width as shown.

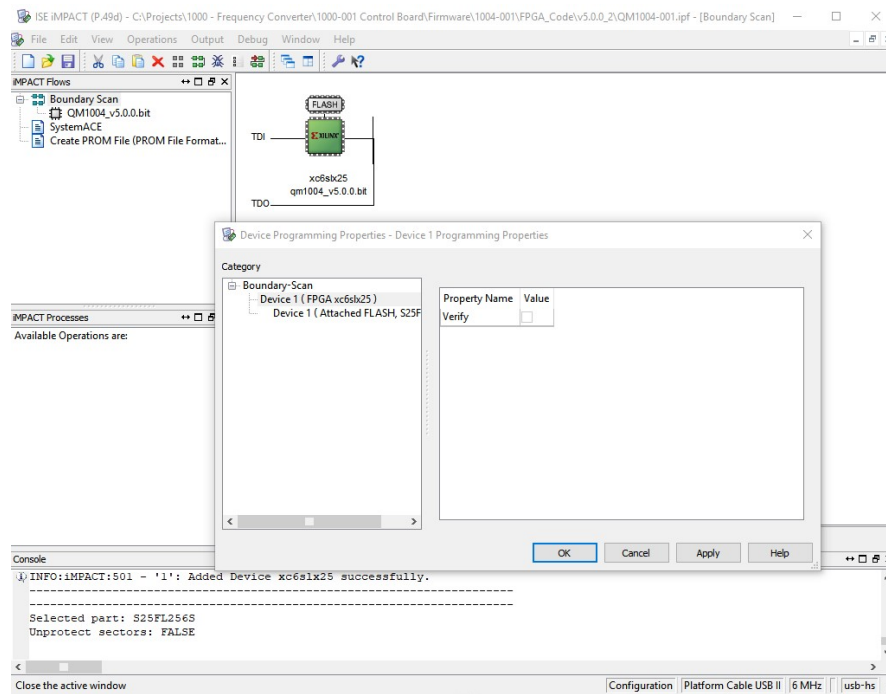

**Figure 2.7: iMPACT: FPGA Programming Properties**

On the first Device Programming Properties screen, leave the box to verify the FPGA write unchecked and click 'OK'.

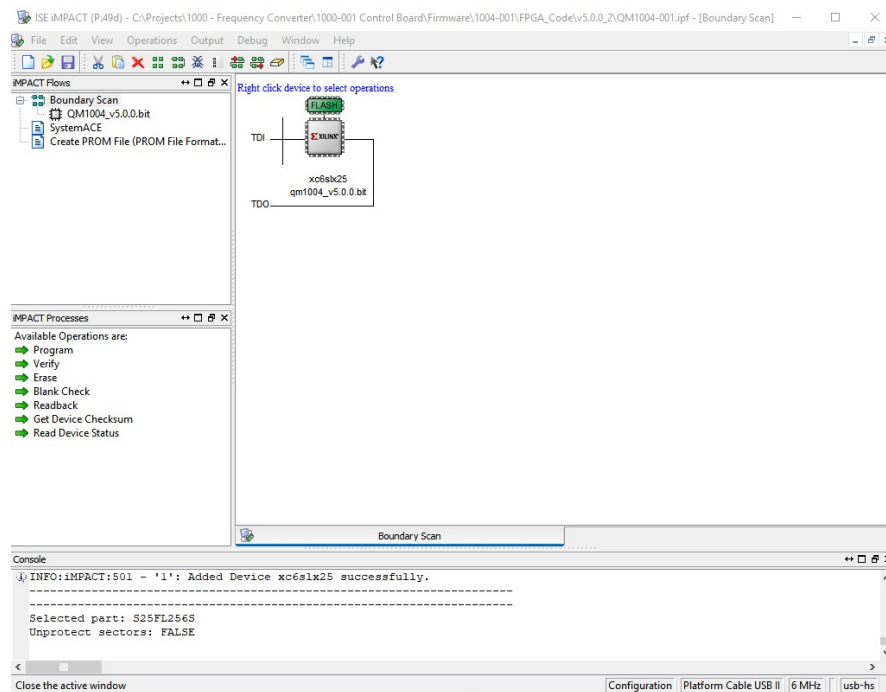

**Figure 2.8: iMPACT: FPGA Programming Properties**

Click the FLASH device to select the PROM as the device to be programmed.



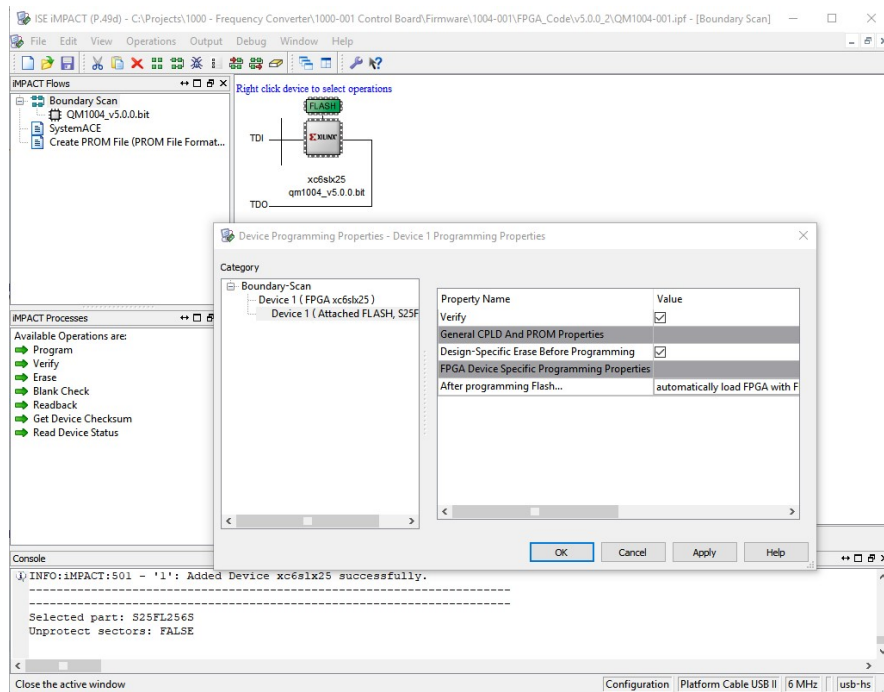

**Figure 2.9:** iMPACT: FLASH Programming Properties

Right-click the FLASH device and click Program, which will open the Device Programming Properties for the PROM. Leave Verify and Erase Before Programming both checked, and leave the After Programming selection set to automatically load FPGA when finished (all defaults) and click 'OK'.

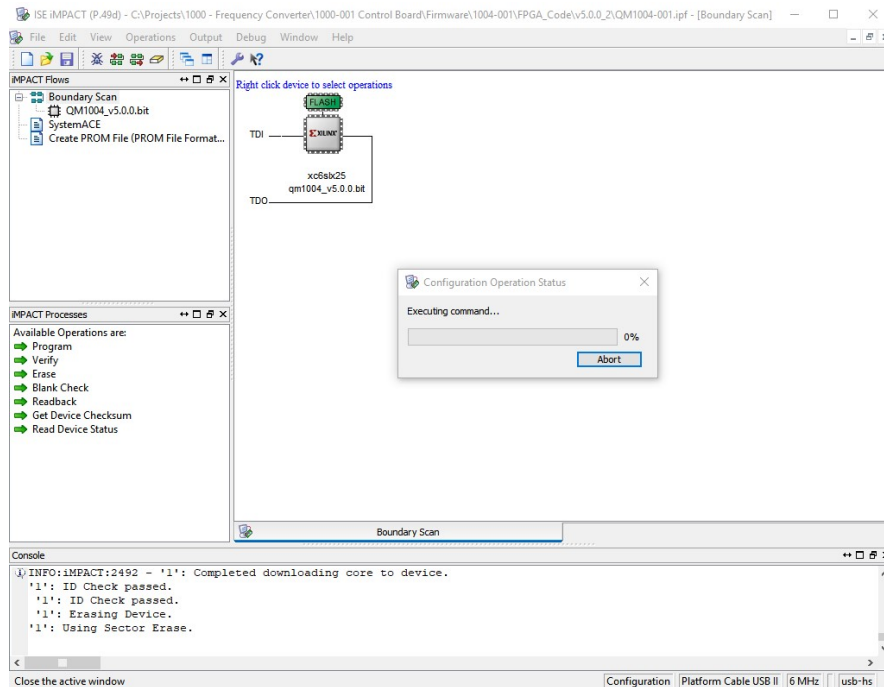

**Figure 2.10:** iMPACT: Programming

The erase and write operations will begin and show a Configuration Operation Status bar.

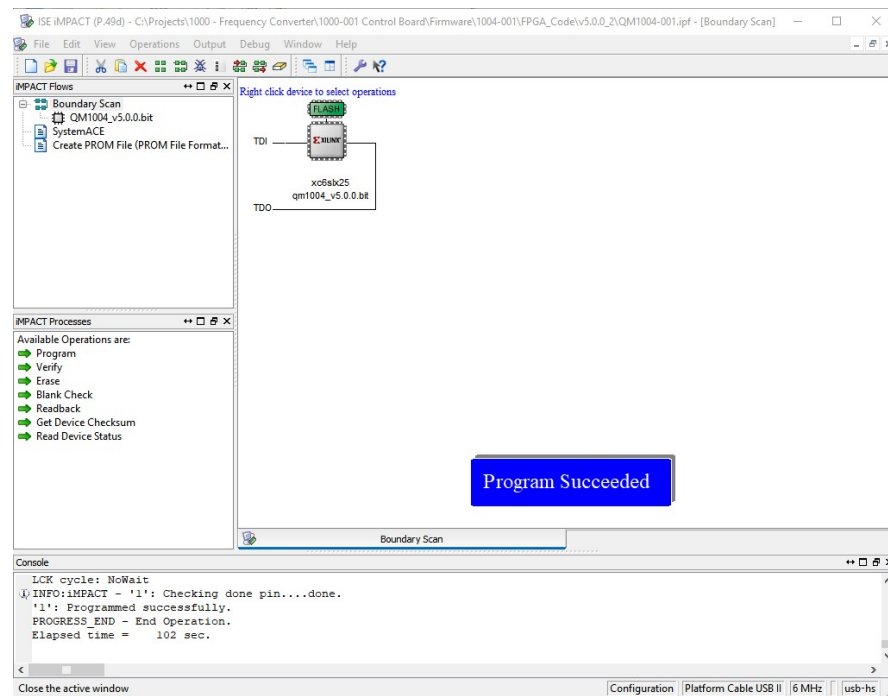

**Figure 2.11: iMPACT: Program Succeeded**

The status will go up to 4% before completing and displaying 'Program Succeeded'. This PROM write took 102 seconds, which is typical for a PROM write to this device. The Single Channel RF Downconverter should then be power-cycled, as the image is loaded to the FPGA on power-up by the PIC.

## 4. PIC Firmware Updates

The QM1003-0.5-18-1-100-205 uses a Microchip Tehcnology, Inc. PIC32MZ2048EFH144 processor. The PIC Firmware update process is performed using a Custom Computer Services, Inc. (CCS) ICD-U64 Debugger/Programmer, but can be done using any In-Circuit Serial Programmer (ICSP) with an RJ-12 connection that supports the Microchip PIC32MZ2048EFH144 device. The ICD-U64 from CCS includes the CCSLOAD free programmer control software, which is used to load the update.

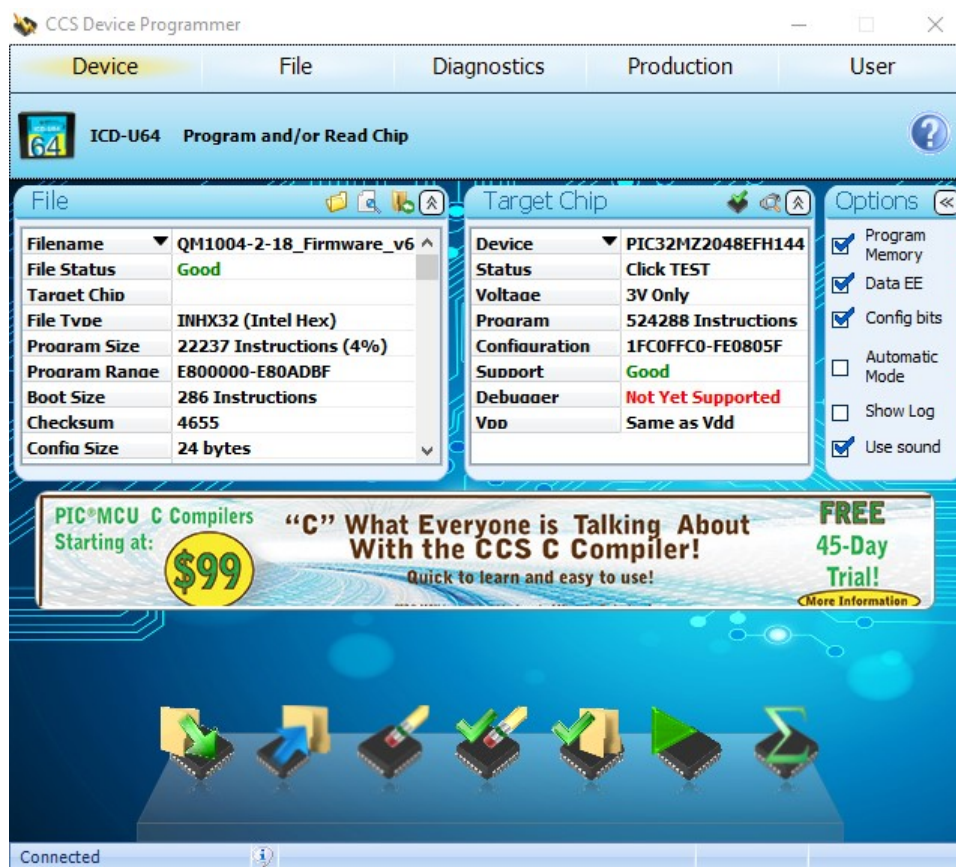

Figure 2.12: CCSLOAD: PIC Programming

After opening CCSLOAD, simply click the Open File icon and select the QM1003-0.5-18-1\_v1.0.0.hex file. The PIC32MZ version currently also requires additionally selecting the Device field, which opens the Select Target Device dialog, where the PIC32MZ2048EFH144 device must be selected. Once properly setup, select the 'Write to Chip' icon. After programming, close CCSLOAD to run the new firmware version.



# 3 Remote Operation

## In This Chapter

1.	Introduction . . . . .	19
1.1	USB Configuration . . . . .	19
1.2	Command Syntax . . . . .	19
1.2.1	Mnemonic Forms . . . . .	19
1.2.2	Using a Semicolon(;) . . . . .	19
1.2.3	Using Whitespace . . . . .	19
1.2.4	Using "?" Commands . . . . .	19
1.2.5	Using "*" Commands . . . . .	19
1.3	Diagram Syntax Conventions . . . . .	19
1.4	Default Units . . . . .	20
1.5	Status Reporting . . . . .	20
1.6	SCPI Data Types . . . . .	20
1.6.1	<boolean> Definition . . . . .	20
1.6.2	<character_data> Definition . . . . .	21
1.6.3	<NAN> Definition . . . . .	21
1.6.4	<non-decimal numeric> Definition . . . . .	21
1.6.5	<NRf> Definition . . . . .	21
1.6.6	<NR1> Definition . . . . .	21
1.6.7	<NR2> Definition . . . . .	21
1.6.8	<NR3> Definition . . . . .	22
1.6.9	<numeric_value> Definition . . . . .	22
1.6.10	<string> Definition . . . . .	22
1.7	Input Message Terminators . . . . .	23
1.8	Compliance Information . . . . .	23
1.8.1	IEEE-488.2 Compliance . . . . .	23
1.8.2	USBTMC Compliance . . . . .	23

1.8.3 VISA Compliance . . . . . 24

2. VISA Descriptors and Configuration . . . . . 25

2.1 USBTMC . . . . . 25

2.1.1 VISA Descriptors . . . . . 25

2.1.2 USBTMC VISA Code Example . . . . . 25

*The following markings apply to the QM1003-0.5-18-1-100-205 Single Channel RF Downconverter family of products.*

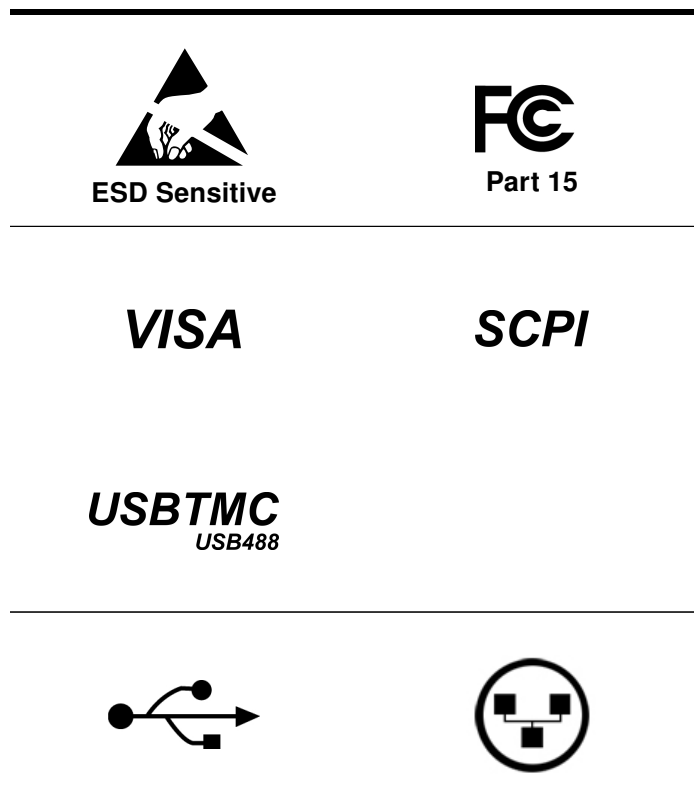

## 1. Introduction

### 1.1 USB Configuration

The Quonset Microwave QM1003-0.5-18-1-100-205 Single Channel RF Downconverter has been designed to configure as a USBTMC or TCPIP device. No additional drivers are required.

The QM1003-0.5-18-1-100-205 has been designed to be VISA and SCPI compliant and as such, all you need in order to communicate with the Single Channel RF Downconverter is a VISA library installed on your machine. The QM1003-0.5-18-1-100-205 has been designed using the NI-VISA Runtime Engine, which is included with the GUI.

### 1.2 Command Syntax

In this manual, the following command syntax conventions are used:

- Square brackets ([ ]) indicate multiple keywords, one of which must be used
- Bars(|) can be read as "or" and are used to separate parameter options.

#### 1.2.1 Mnemonic Forms

Each keyword has both a long and short form. A standard notation is used to differentiate the short form and long form keyword. The long form of the keyword is shown, with the short form of the keyword shown in uppercase letters and the rest of the keyword is shown in lowercase letters. For example, the short form of *FREQuency* is *FREQ*.

#### 1.2.2 Using a Semicolon(;)

Use a semicolon to separate two commands within the same command string.

#### 1.2.3 Using Whitespace

You *must* use whitespace characters, [tab], or [space] to separate a parameter from a keyword.

#### 1.2.4 Using "?" Commands

The bus controller may send commands at any time, but a SCPI instrument may only send a response when specifically instructed to do so. Only commands that end with a "?", henceforth referred to as queries, instruct the instrument to send a response message. Queries can return either measured values, instrument settings, or internal status codes.

**Note:** *If you send multiple queries without reading the response between queries, only the result of the last query will be returned when the response is read. The query buffer is a first-in first-out configuration.*

#### 1.2.5 Using "\*" Commands

Commands starting with a "\*" are called common commands. They are required to perform identical functions for all instruments that are compliant with the IEEE-488.2 interface standard. The "\*" commands are used to control reset, self-test, and status operations in the Single Channel RF Downconverter.

### 1.3 Diagram Syntax Conventions

- Solid lines represent the recommended path
- Ovals enclose command mnemonics. The command mnemonic must be entered exactly as shown in the oval.
- Dotted lines indicate an optional path for passing secondary or optional keywords.

- Arrows and curved intersections indicate command path direction.
- All diagrams flow from left to right. A path may not travel to the left except in a bypass loop.

#### 1.4 Default Units

Unless otherwise specified, the following units are assumed:

**Table 3.2:** Default Units

Current	A
Frequency	GHz
Power	dBm
Time	$\mu$ s
Temperature	°C
Voltage	Volts

#### 1.5 Status Reporting

Status reporting is used to monitor the Single Channel RF Downconverter to determine which events have occurred. Status reporting is accomplished by configuring and reading status registers.

The Single Channel RF Downconverter has the following main registers:

- Status Register
- Standard Event Register
- Operation Status Register
- Questionable Status Register
- Device Status Register

Status and Standard Event registers are read using the IEEE-488.2 common commands.

Operation and Questionable Status registers are read using the SCPI *STAT* subsystem.

#### 1.6 SCPI Data Types

The SCPI language defines different formats for use in program messages and response messages. Instruments are flexible listeners and can accept commands and parameters in various formats. However, SCPI instruments are precise talkers. This means that SCPI instruments *always* responds to a particular query in a predefined, rigid format.

##### 1.6.1 <boolean> Definition

Throughout this document <*boolean*> is used to represent *ON|OFF* <*NRf*>. Boolean parameters have a value of *0* or *1* and are unitless. *ON* corresponds to *1* and *OFF* corresponds to *0*.

On input, an <*NRf*> is rounded to an integer. A nonzero result is interpreted as *1*.

Queries always return a *1* or a *0*, never *ON* or *OFF*.

**1.6.2 <character\_data> Definition**

Throughout this document, <character\_data> is used to represent character data, that is, A-Z, a-z, 0-9 and \_ (underscore). STOP and A4\_U2 are examples of character data. The first character must be alphanumeric, followed by either alphanumeric or underscore characters up to a maximum of 12 characters.

**1.6.3 <NAN> Definition**

Not a number (NAN) is represented as 9.91 E37. Not a number is defined in IEEE 754.

**1.6.4 <non-decimal numeric> Definition**

Throughout this document, <non-decimal numeric> is used to represent numeric information in bases other than 10 (that is, hexadecimal, octal, and binary). Examples of non-decimal numeric include #HFF4, #hff4, #Q25, #q25, and #B101011.

**1.6.5 <NRf> Definition**

Throughout this document, <NRf> is used to denote a flexible numeric representation. The following show examples of <NRf>

- +185
- -10
- +1.2E09

**1.6.6 <NR1> Definition**

Throughout this document, <NR1> numeric response data is defined as:

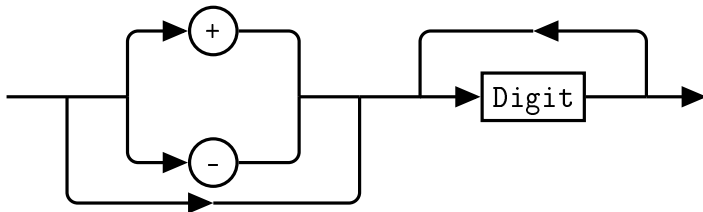

The following shows the examples of <NR1>:

- 127
- +127
- -12345

**1.6.7 <NR2> Definition**

Throughout this document, <NR2> numeric response data is defined as:

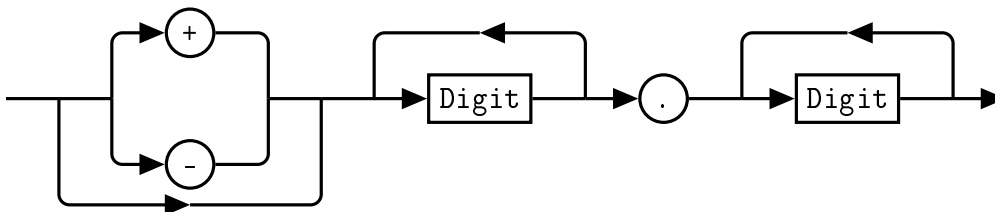

The following shows the examples of <NR2>:



- 12.7
- +127
- -1.2345
- -0.123

### 1.6.8 <NR3> Definition

Throughout this document, <NR3> numeric response data is defined as:

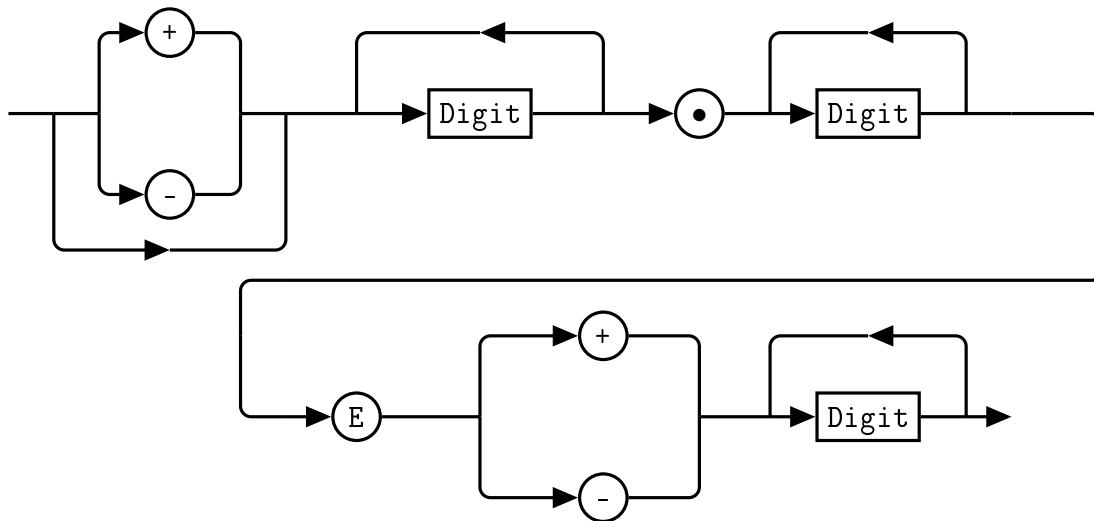

The following shows the examples of <NR3>:

- 1.23E+4
- 12.3E-45

### 1.6.9 <numeric\_value> Definition

Throughout this document, the decimal numeric element is abbreviated to <numeric\_value>.

### 1.6.10 <string> Definition

Throughout this document, <string> is used to represent the 7-bit ASCII characters. The format is defined as:

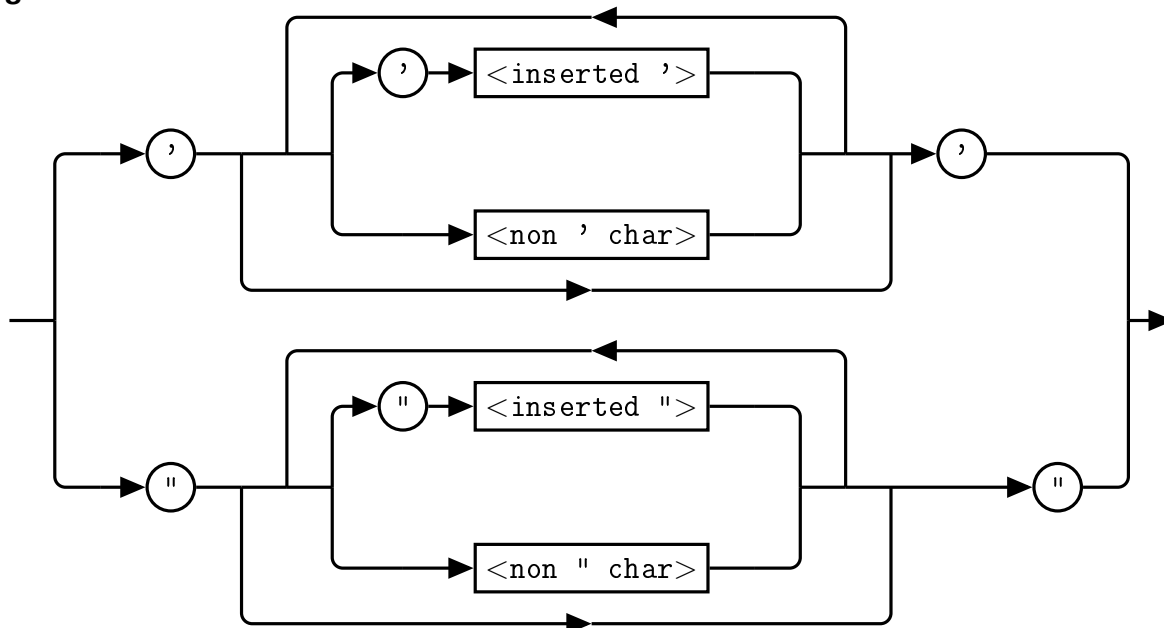
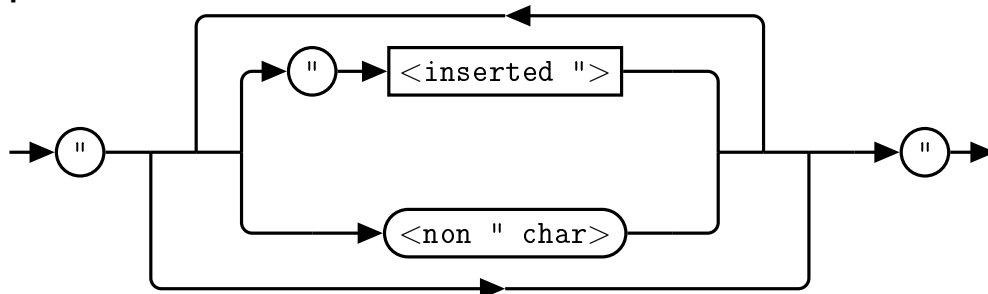
**Program Data****Response Data****1.7 Input Message Terminators**

Program messages sent to a SCPI instrument *must* terminate with a <newline> character. The IEEE.488 EOI (end or identify) signal is interpreted as a <newline> character and may also be used to terminate a message in place of the <newline> character. A <carriage return> followed by a <newline> character is also accepted. Many programming languages allow you to specify a message terminator character or EOI state to be automatically sent with each bus transaction. Message termination *always* sets the current path back to the root-level.

**1.8 Compliance Information****1.8.1 IEEE-488.2 Compliance**

The Single Channel RF Downconverter complies with the rules and regulations of the of the IEEE-488.2 standard which are applicable to USB controlled devices.

**1.8.2 USBTMC Compliance**

The QM1003-0.5-18-1-100-205 Single Channel RF Downconverter complies with the rules and regulations of the of the USBTMC (USB Test and Measurement Class). When connected to a USB bus, the QM1003-0.5-18-1-100-205 will configure as a USB Test and Measurement device.

### **1.8.3 VISA Compliance**

The QM1003-0.5-18-1-100-205 Single Channel RF Downconverter complies with the rules and regulations of the VISA (Virtual Instrument Systems Architecture) standard. Communication with the QM1003-0.5-18-1-100-205 is accomplished through VISA libraries, providing portability between different operating systems. *No additional drivers are required.*

## 2. VISA Descriptors and Configuration

### 2.1 USBTMC

#### 2.1.1 VISA Descriptors

To communicate with the Quonset Microwave QM1003-0.5-18-1-100-205 Single Channel RF Downconverter as a USBTMC device, use the following USB VISA descriptor format:

```
USB[board number]::manufacturer ID::model code::serial number::INSTR
```

#### Descriptor Example

```
USB0::0x2012::0x002C::0001::INSTR
```

#### 2.1.2 USBTMC VISA Code Example

```
ViSession rscmng;  
ViSession qm1003;  
char buf[256] = 0;  
  
viOpenDefaultRM(&rscmng);  
viOpen(rscmng,(ViRsrc)"USB0::0x2012::0x002C::0001::INSTR",VI_NULL,VI_NULL,&qm1003);  
viPrintf(qm1003,(ViString)"*IDN?\n");  
viScanf(qm1003,(ViString)"%t",&buf);  
viClose((ViObject)qm1003);  
viClose((ViObject)rscmng);
```

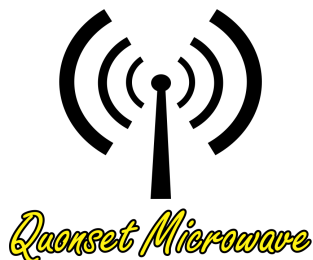

# 4 Control Commands

## In This Chapter

1. Command Quick Reference Guide . . . . .	28
1.1 Common (*) Commands . . . . .	28
1.2 FREQuency Subsystem . . . . .	29
1.3 POWEr Subsystem . . . . .	29
1.4 STATus Subsystem . . . . .	30
1.5 SYSTem Subsystem . . . . .	30
2. FREQuency Subsystem Command Reference . . . . .	31
2.1 FREQuency:ASR . . . . .	31
2.2 FREQuency:LOCK . . . . .	32
2.3 FREQuency:MODE . . . . .	33
2.4 FREQuency:TUNE . . . . .	34
2.5 FREQuency:TUNErACTual . . . . .	35
2.6 FREQuency:LO1:EXTernal . . . . .	36
2.7 FREQuency:LO1:LOCK . . . . .	37
2.8 FREQuency:LO2:EXTernal . . . . .	38
2.9 FREQuency:LO2:LOCK . . . . .	39
2.10 FREQuency:REFeRence:EXTernal . . . . .	40
3. POWEr Subsystem Command Reference . . . . .	41
3.1 POWEr:AT1 . . . . .	41
3.2 POWEr:AT2 . . . . .	42
3.3 POWEr:RF . . . . .	43
4. STATus Subsystem Command Reference . . . . .	44
4.1 STATus:OPERation . . . . .	44
4.2 STATus:OPERation:CONDition . . . . .	45
4.3 STATus:OPERation:ENABle . . . . .	46
4.4 STATus:PRESet . . . . .	47

4.5	STATus:QUEStionable . . . . .	48
4.6	STATus:QUEStionable:CONDition . . . . .	49
4.7	STATus:QUEStionable:ENABle . . . . .	50
5.	SYSTem Subsystem Command Reference . . . . .	51
5.1	SYSTem:BOOTstate . . . . .	51
5.2	SYSTem:CURRent . . . . .	52
5.3	SYSTem:ERRor . . . . .	53
5.4	SYSTem:FIRMware . . . . .	57
5.5	SYSTem:LOADstate . . . . .	58
5.6	SYSTem:OPTions . . . . .	59
5.7	SYSTem:READstate . . . . .	60
5.8	SYSTem:SAVEstate . . . . .	61
5.9	SYSTem:SERialNUMber . . . . .	62
5.10	SYSTem:USBPID . . . . .	63
5.11	SYSTem:VERSion . . . . .	64
6.	IEEE 488.2 Command Reference . . . . .	65
6.1	Introduction . . . . .	65
6.2	*CLS . . . . .	66
6.3	*ESE <NRf> . . . . .	67
6.4	*ESR? . . . . .	68
6.5	*IDN? . . . . .	69
6.6	*OPC . . . . .	70
6.7	*RCL <NRf> . . . . .	71
6.8	*RST . . . . .	72
6.9	*SAV <NRf> . . . . .	73
6.10	*SDS <NRf> . . . . .	74
6.11	*SRE <NRf> . . . . .	75
6.12	*STB? . . . . .	76
6.13	*TST? . . . . .	77
6.14	*WAI . . . . .	78

## 1. Command Quick Reference Guide

### 1.1 Common (\*) Commands

**Table 4.1:** Common (\*) Commands Summary

Command	Page	Description
*CLS	66	Clears the data structures. The SCPI registers are cleared.
*ESE <NRf>	67	Sets the Standard Event Status Enable Register.
*ESE?	67	Returns the Standard Event Status Enable Register.
*ESR?	68	Returns the contents of the Standard Event Status Register and then clears it.
*IDN?	69	Returns the identification of the device connected to the computer (Host).
*OPC	70	Causes the Single Channel RF Downconverter to set the operation complete bit in the Standard Event Status Register when all pending operations have completed.
*OPC?	70	Returns the operation complete bit in the Standard Event Status Register when all pending operations have completed.
*RCL <NRf>	71	Recalls the settings of the Single Channel RF Downconverter from the specified register (memory location).
*RST	72	Returns the Single Channel RF Downconverter to its initial power up state.
*SAV <NRf>	73	Saves the settings of the Single Channel RF Downconverter to the specified register (memory location).
*SDS <NRf>	74	Saves the default settings of the Single Channel RF Downconverter to the specified register (memory location).
*SRE <NRf>	75	Sets the Service Request Enable register bits.
*SRE?	75	Returns the Service Request Enable register bits.
*STB?	76	Returns the Single Channel RF Downconverter status byte.
*TST?	77	Performs a self-test and returns the result.
*WAI	78	Causes the Single Channel RF Downconverter to wait until either all pending commands are complete, the Device Clear command is received, or the power is cycled before executing any subsequent commands or queries.

## 1.2 FREQUENCY Subsystem

**Table 4.2:** FREQUENCY Subsystem Commands Summary

Command	Page	Description
FREQUENCY:ASR	31	Turns on or off Active Spur Reduction.
FREQUENCY:LOCK	32	Returns the lock status of the internal LOs.
FREQUENCY:MODE	33	Sets or Returns the downconverter's operating mode.
FREQUENCY:TUNE	34	Sets or Returns the desired tuning frequency in GHz.
FREQUENCY:TUNERACTUAL	35	Returns the actual tuning frequency of the device in GHz.
FREQUENCY:LO1:EXTERNAL	36	Sets or Returns internal/external status of the LO1 oscillator.
FREQUENCY:LO1:LOCK	37	Returns the lock status of the internal LO1 for the system.
FREQUENCY:LO2:EXTERNAL	38	Sets or Returns internal/external status of the LO2 oscillator.
FREQUENCY:LO2:LOCK	39	Returns the lock status of the internal LO2 for the system.
FREQUENCY:REFERENCE:EXTERNAL	40	Sets or Returns whether the internal or external supplied reference oscillator is used.

## 1.3 POWER Subsystem

**Table 4.3:** POWER Subsystem Commands Summary

Command	Page	Description
POWER:AT1	41	Sets or Returns the value of the downconverter's first attenuator.
POWER:AT2	42	Sets or Returns the value of the downconverter's second attenuator.
POWER:RF	43	Turns on or off the RF output of the device.



## 1.4 STATus Subsystem

**Table 4.4:** STATus Subsystem Commands Summary

Command	Page	Description
STATus:OPERation	44	Returns the contents of the status event register.
STATus:OPERation:CONDition	45	Returns the contents of the condition register.
STATus:OPERation:ENABle	46	Sets the enable bit mask for the status event register.
STATus:PRESet	47	Presets the STATus:QUEStionable:ENABle register.
STATus:QUEStionable	48	Returns the contents of the questionable register.
STATus:QUEStionable:CONDition	49	Returns the contents of the questionable condition register.
STATus:QUEStionable:ENABle	50	Sets the enable bit mask for the questionable register.

## 1.5 SYSTem Subsystem

**Table 4.5:** SYSTem Subsystem Commands Summary

Command	Page	Description
SYSTem:BOOTstate	51	Specifies a state to boot to at device startup.
SYSTem:CURRent	52	Returns the current draw of the device.
SYSTem:ERRor	53	Returns error numbers and messages from the error queue.
SYSTem:FIRMware	57	Returns the current firmware version of the device.
SYSTem:LOADstate	58	Loads and sets the parameters from the specified state.
SYSTem:READstate	60	Reads the parameters from the stored state without changing the current device setup.
SYSTem:SAVEstate	61	Saves the current parameters to a specified state number.
SYSTem:SERialNUMBER	62	Returns the serial number of the device.
SYSTem:USBPID	63	Returns the USB PID of the device.
SYSTem:VERSion	64	Returns the version of SCPI implemented in the Single Channel RF Downconverter.

## 2. FREQuency Subsystem Command Reference

### 2.1 FREQuency:ASR[ON|OFF|1|0]

This command turns the system's Active Spur Reduction on or off.

When *0* or *OFF* is specified, ASR is turned off.

When *1* or *ON* is specified, ASR is turned on.

#### Syntax

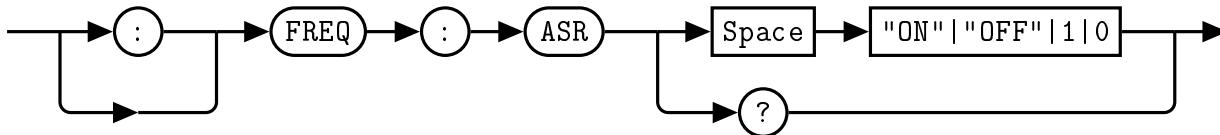

#### Example

:FREQ:ASR 1 *This command turns ASR on.*

#### Default Condition

On power up, or when a *\*RST* command is issued, the QM1003-0.5-18-1-100-205 returns to the boot state's setting. The Single Channel RF Downconverter default setting is 1.

#### Query

:FREQ:ASR? *This query returns the state of the ASR settings.*

#### Error Message

If the parameter is not in the recognized format, error *-102*, "Syntax error" occurs.

## 2.2 FREQuency:LOCK

This query allows the user to check the lock status of the internal LOs to the reference signal.

**Note: R01 hardware contains a DRO that does not allow LO2 lock status reporting and only returns LO1 lock status. All other revisions provide LO2 lock status.**

### Syntax

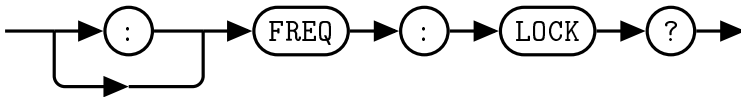

### Query

**:FREQ:LOCK?** *This query returns the lock status of the internal LOs. A lock status of 0 indicates that the LOs are unlocked, while a lock status of 1 indicates the LOs are locked.*

### 2.3 FREQuency:MODE <numeric value>

This command allows the user to set the converter mode of the QM1003-0.5-18-1-100-205. The mode setting controls the converter bypass, the input amp, and the output amp. The range of acceptable mode values is 0-4 and are described as follows:

**Table 4.6:** Converter Operation Modes

Converter Mode	Converter Status	Input Amplifier	Output Amplifier
0	Bypassed	Off	Off
1	Enabled	Off	Off
2	Enabled	Off	On
3	Enabled	On	Off
4	Enabled	On	On

#### Syntax

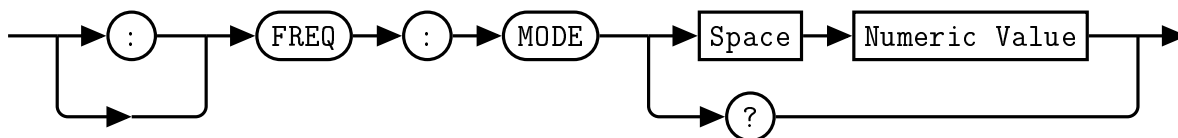

#### Example

:FREQ:MODE 1

*This command sets the converter mode of the QM1003-0.5-18-1-100-205 to 1, which enables the converter, and disables both the input and output amplifiers.*

#### Default Condition

On power up, or when a \*RST command is issued, the QM1003-0.5-18-1-100-205 returns to the boot state's setting. The Single Channel RF Downconverter default setting is 1.

#### Query

:FREQ:MODE? *This query returns the converter mode of the QM1003-0.5-18-1-100-205.*

#### Error Message

If the parameter is not in the recognized format, error -102, "Syntax error" occurs.

If the parameter is less than 0 or greater than 4, error -222, "Data out of range" occurs.

## 2.4 FREQuency:TUNE <numeric value>

This command allows the user to set the tuner frequency of the QM1003-0.5-18-1-100-205. The frequency value is specified in GHz. The range of acceptable tune frequency values is 0.5-18 GHz with a 6 decimal places and a 2 Hz tuning resolution. This resolution can be made finer if necessary via a future firmware update.

### Syntax

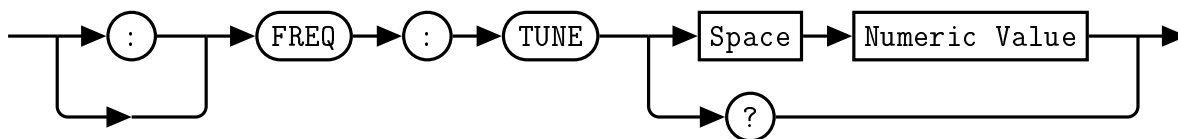

### Example

:FREQ:TUNE 9.25      *This command sets the center frequency of the QM1003-0.5-18-1-100-205 to 9.25 GHz.*

### Default Condition

On power up, or when a \*RST command is issued, the QM1003-0.5-18-1-100-205 returns to the boot state's setting. The Single Channel RF Downconverter default setting is 9.25.

### Query

:FREQ:TUNE?      *This query returns the center frequency of the QM1003-0.5-18-1-100-205 in GHz.*

### Error Message

If the parameter is not in the recognized format, error -102, "Syntax error" occurs.

If the parameter is not between 0.5 and 18, error -222, "Data out of range" occurs.

## 2.5 FREQuency:TUNErACTual

This query returns the actual tuner frequency of the QM1003-0.5-18-1-100-205 in GHz. This can be different than the set frequency if a set frequency finer than the tuning resolution is entered.

### Syntax

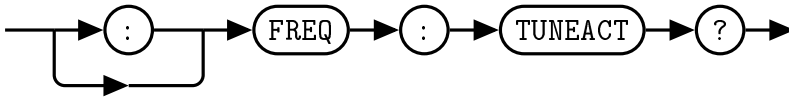

### Query

:FREQ:TUNEACT? *This query returns the actual tuner frequency of the QM1003-0.5-18-1-100-205 in GHz.*

## 2.6 FREQuency:LO1:EXTernal [1|0]

This command allows the user to select between the internal LO1 local oscillator and an externally supplied one.

When *0* is specified, the internal LO1 local oscillator is used by the Single Channel RF Downconverter. When *1* is specified, the external LO1 input is used by the Single Channel RF Downconverter.

### Syntax

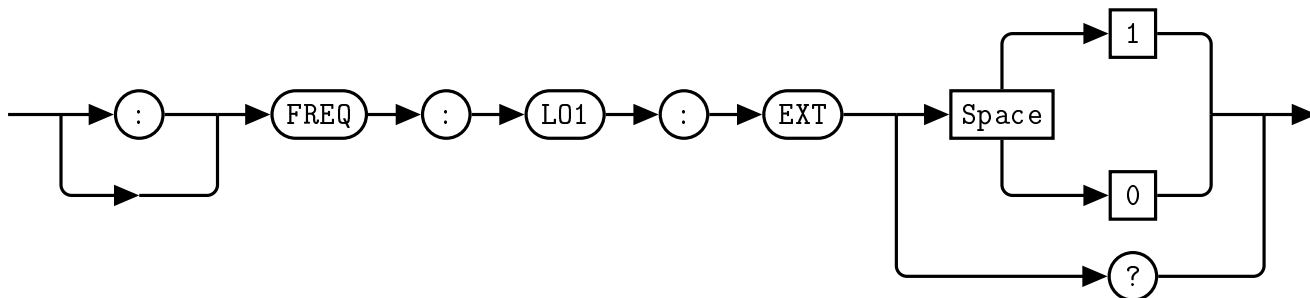

### Example

:FREQ:LO1:EXT 0      *This command selects the internal LO1 oscillator.*

### Default Condition

On power up, or when a \*RST command is issued, the QM1003-0.5-18-1-100-205 returns to the boot state's setting. The Single Channel RF Downconverter default setting is 0.

### Query

:FREQ:LO1:EXT?      *This query returns a 0 or 1 to indicate the selected Single Channel RF Downconverter reference mode*

- 0 is returned if the internal LO1 oscillator is selected
- 1 is returned if the external LO1 is selected

### Error Message

If the parameter is not in the recognized format, error -102, "Syntax error" occurs.

If the parameter is not 1 or 0, error -222, "Data out of range" occurs.

## 2.7 FREQuency:LO1:LOCK

This query allows the user to check the lock status of the internal LO1 to the reference signal for the Single Channel RF Downconverter.

### Syntax

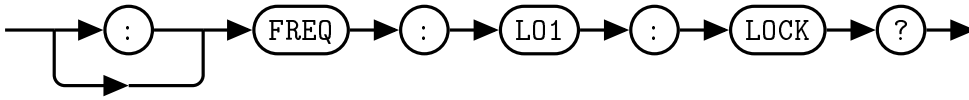

### Query

:FREQ:LO1:LOCK? *This query returns the lock status of the internal LO1. A lock status of 0 indicates that the LO1 is unlocked, while a lock status of 1 indicates the LO1 is locked.*



## 2.8 FREQuency:LO2:EXTernal [1|0]

This command allows the user to select between the internal LO2 local oscillator and an externally supplied one.

When *0* is specified, the internal LO2 local oscillator is used by the Single Channel RF Downconverter. When *1* is specified, the external LO2 input is used by the Single Channel RF Downconverter.

### Syntax

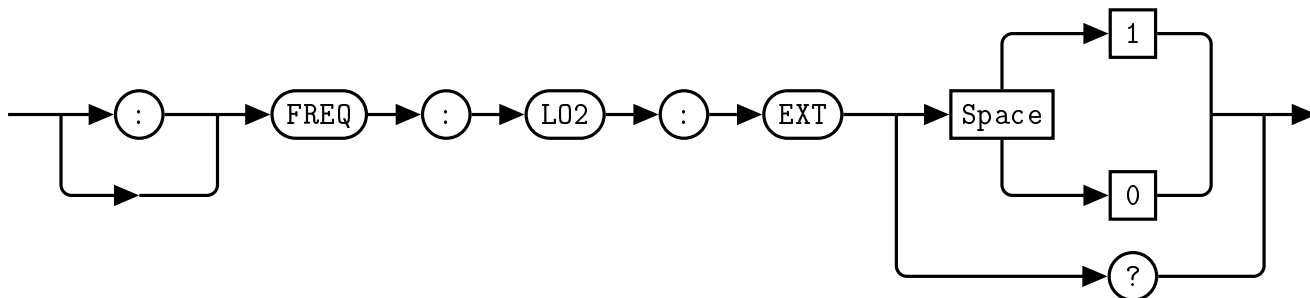

### Example

:FREQ:LO2:EXT 0      *This command selects the internal LO2 oscillator.*

### Default Condition

On power up, or when a \*RST command is issued, the QM1003-0.5-18-1-100-205 returns to the boot state's setting. The Single Channel RF Downconverter default setting is 0.

### Query

:FREQ:LO2:EXT?      *This query returns a 0 or 1 to indicate the selected Single Channel RF Downconverter reference mode*

- 0 is returned if the internal LO2 oscillator is selected
- 1 is returned if the external LO2 is selected

### Error Message

If the parameter is not in the recognized format, error -102, "Syntax error" occurs.  
If the parameter is not 1 or 0, error -222, "Data out of range" occurs.

## 2.9 FREQuency:LO2:LOCK

This query allows the user to check the lock status of the internal LO2 to the reference signal.

**Note: R01 hardware contains a DRO that does not allow LO2 lock status reporting and only returns LO1 lock status. All other revisions provide LO2 lock status.**

### Syntax

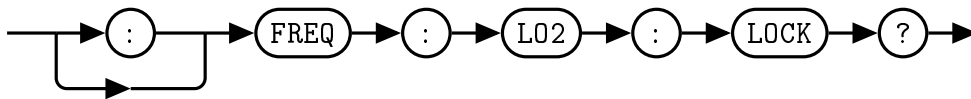

### Query

:FREQ:LO2:LOCK? *This query returns the lock status of the internal LO2. A lock status of 0 indicates that the LO2 is unlocked, while a lock status of 1 indicates the LO2 is locked.*

## 2.10 FREQuency:REFerence:EXTernal [1|0]

This command allows the user to select between the internal 10 MHz reference and an externally supplied reference.

When *0* is specified, the internal reference oscillator is used by the Single Channel RF Downconverter. When *1* is specified, the external reference input is used by the Single Channel RF Downconverter.

### Syntax

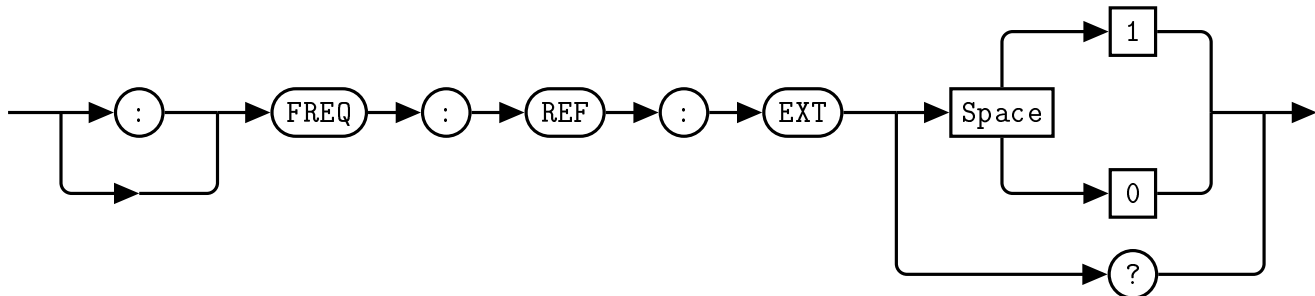

### Example

:FREQ:REF:EXT 0      *This command selects the internal reference oscillator.*

### Default Condition

On power up, or when a \*RST command is issued, the QM1003-0.5-18-1-100-205 returns to the boot state's setting. The Single Channel RF Downconverter default setting is 0.

### Query

:FREQ:REF:EXT?      *This query returns a 0 or 1 to indicate the selected Single Channel RF Downconverter reference mode*

- 0 is returned if the internal reference oscillator is selected
- 1 is returned if the external reference is selected

### Error Message

If the parameter is not in the recognized format, error -102, "Syntax error" occurs.

If the parameter is not 1 or 0, error -222, "Data out of range" occurs.

### 3. POWER Subsystem Command Reference

#### 3.1 POWER:AT1 <numeric value>

This command allows the user to set the RF attenuation level of the QM1003-0.5-18-1-100-205 down-converter's first attenuator to a specified numeric value. The range of acceptable attenuation values is 0 - 31.5 dB in 0.5 dB steps.

#### Syntax

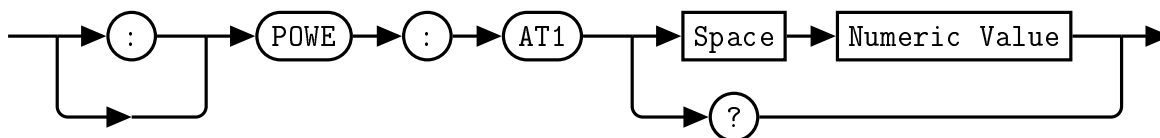

#### Example

:POWE:AT1 31.5 *This command sets the downconverter's first attenuator to 31.5 dB*

#### Default Condition

On power up, or when a \*RST command is issued, the QM1003-0.5-18-1-100-205 downconverter's first attenuator level returns to the boot state's setting. The Single Channel RF Downconverter default setting is 0.

#### Query

:POWE:AT1? *This query returns the current downconverter's first attenuator level.*

#### Error Message

If the parameter is not in the recognized format, error -102, "Syntax error" occurs.

If the parameter is less than 0 or greater than 31.5, error -222, "Data out of range" occurs.

### 3.2 POWER:AT2 <numeric value>

This command allows the user to set the RF attenuation level of the QM1003-0.5-18-1-100-205 downconverter's second attenuator to a specified numeric value. The range of acceptable attenuation values is 0 - 31.5 dB in 0.5 dB steps.

#### Syntax

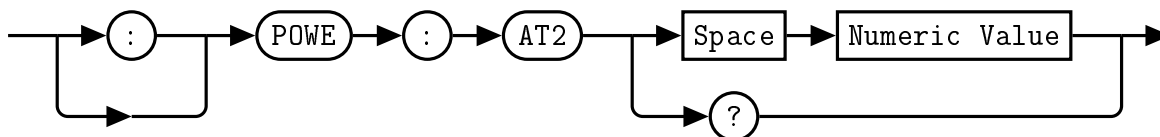

#### Example

:POWE:AT2 31.5 *This command sets the downconverter's second attenuator to 31.5 dB*

#### Default Condition

On power up, or when a \*RST command is issued, the QM1003-0.5-18-1-100-205 downconverter's second attenuator level returns to the boot state's setting. The Single Channel RF Downconverter default setting is 0.

#### Query

:POWE:AT2? *This query returns the current downconverter's second attenuator level.*

#### Error Message

If the parameter is not in the recognized format, error -102, "Syntax error" occurs.

If the parameter is less than 0 or greater than 31.5, error -222, "Data out of range" occurs.

### 3.3 POWER:RF [ON|OFF|1|0]

This command allows the user to turn on and off the RF power of the QM1003-0.5-18-1-100-205.

When *0* or *OFF* is specified, the RF power is turned off.

When *1* or *ON* is specified, the RF power is turned on.

#### Syntax

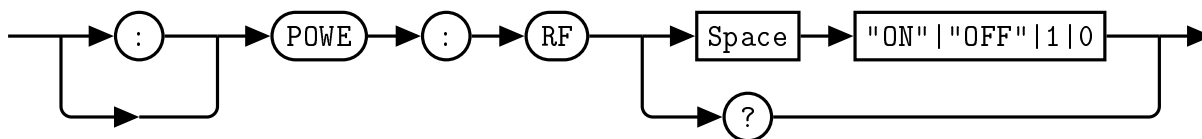

#### Example

:POWE:RF 0 *This command turns off the RF power.*

#### Default Condition

On power up, or when a *\*RST* command is issued, the QM1003-0.5-18-1-100-205 returns to the boot state's setting. The Single Channel RF Downconverter default setting is 0.

#### Query

:POWE:RF? *This query returns a 0 or 1 to indicated the Single Channel RF Downconverter power state.*

- 0 is returned if the RF power is *OFF*
- 1 is returned if the RF power is *ON*

#### Error Message

If the parameter is not in the recognized format, error *-102*, "Syntax error" occurs.

## 4. STATus Subsystem Command Reference

### 4.1 STATus:OPERation?

This query returns the contents of the status event register. Reading from this event register clears it.

The use of the :EVENT token is optional.

#### Syntax

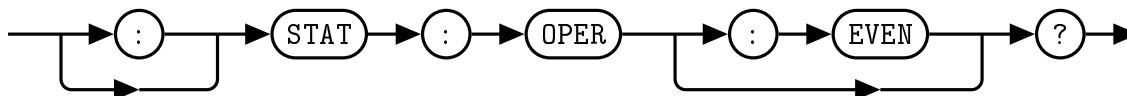

#### Allowed Values

The *NRf* parameter can be any integer in the range of 0 to 32767.

#### Query

:STAT:OPER? *The status event register is queried.*

#### Reset Condition

On reset, the status event register is cleared.

## 4.2 STATus:OPERation:CONDition?

This query returns the contents of the condition register.

### Syntax

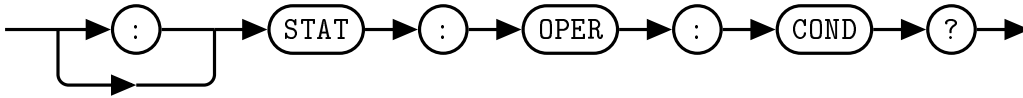

### Allowed Values

The *NRf* parameter can be any integer in the range of 0 to 32767.

### Query

:STAT:OPER:COND? *The condition register is queried.*

### Reset Condition

On reset, the condition register is cleared.



### 4.3 STATus:OPERation:ENABle <NRf>

This command sets the enable mask for the status event register. A bit value of 1 in the mask will allow a positive transition in the associated summary bit of the event register if the event bit transitions to true.

#### Syntax

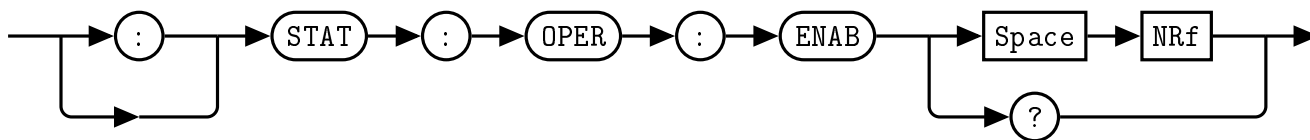

#### Allowed Values

The *NRf* parameter can be any integer in the range of 0 to 32767.

#### Query

:STAT:OPER:ENAB? *The event register enable bit mask is queried.*

#### Reset Condition

On reset, the enable bit mask register is cleared.

#### Error Message

If the parameter is not in the recognized format, error -102, "Syntax error" occurs.

If the parameter is less than 0 or greater than 32767, error -222, "Data out of range" occurs.

#### 4.4 STATus:PRESet

The PRESet command presets the STATus:QUESTionable:ENABLE register to 0. No other registers are affected. \*CLS;\*SRE 0;\*ESE 0 is the recommended command sequence to reset all other status/event registers.

##### Syntax

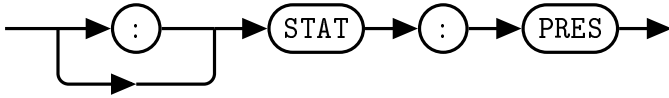

##### Example

:STAT:PRES *The questionable enable register is preset.*

#### 4.5 STATus:QUEStionable?

This query returns the contents of the questionable status register. A value of 1 in the bit indicates the accuracy of the signal is of questionable quality.

The use of the :EVENT token is optional.

#### Syntax

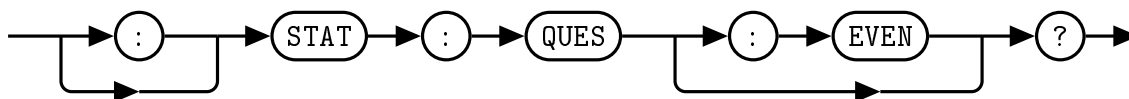

#### Allowed Values

The *NRf* parameter can be any integer in the range of 0 to 32767.

#### Query

:STAT:QUES? *The questionable register is queried.*

#### Reset Condition

On reset, the questionable register is cleared.

#### 4.6 STATus:QUEStionable:CONDition?

This query returns the contents of the questionable condition register.

##### Syntax

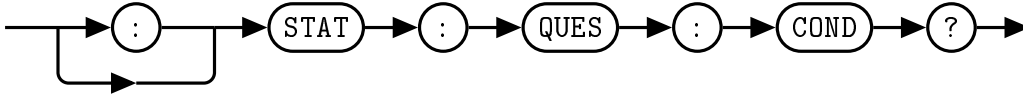

##### Allowed Values

The *NRf* parameter can be any integer in the range of 0 to 32767.

##### Query

:STAT:QUES:COND? *The questionable condition register is queried.*

##### Reset Condition

On reset, the questionable condition register is cleared.

#### 4.7 STATus:QUESTionable:ENABle <NRf>

This command sets the enable mask for the questionable event register. A bit value of 1 in the mask will allow a positive transition in the associated summary bit of the questionable event register if the event bit transitions to true.

##### Syntax

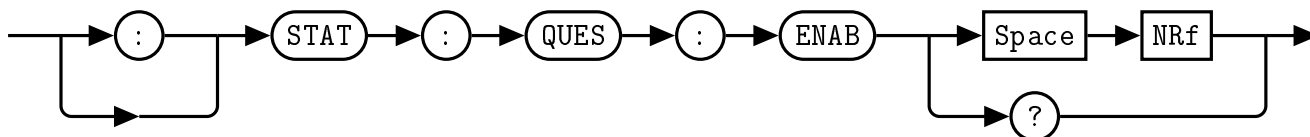

##### Allowed Values

The *NRf* parameter can be any integer in the range of 0 to 32767.

##### Query

:STAT:QUES:ENAB? *The questionable register enable bit mask is queried.*

##### Reset Condition

On reset, the enable bit mask register is cleared.

##### Error Message

If the parameter is not in the recognized format, error -102, "Syntax error" occurs.

If the parameter is less than 0 or greater than 32767, error -222, "Data out of range" occurs.

## 5. SYSTem Subsystem Command Reference

### 5.1 SYSTem:BOOTstate [0-5]

This command specifies a previously saved state to be loaded upon device startup. In addition to factory default state 0, there are 5 re-writeable memory locations. Any of these 6 boot states can be selected by choosing an index between 0 and 5. The restored parameters are the *RF Power State*, *External Reference Enabled*, *External LO1 Enabled*, *External LO2 Enabled*, *Tune Frequency*, *Downconverter Mode*, *Downconverter Attenuator 1*, *Downconverter Attenuator 2*, *Downconverter ASR Enabled*. For a detailed description of the parameters saved, see the relevant command descriptions in this manual. When this command is issued, the selected state will be loaded on the next power cycle or by issuing the *\*RST* command.

#### Syntax

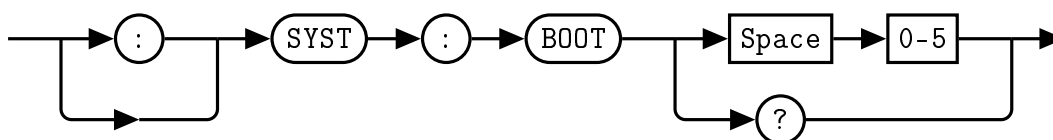

There are 6 memory locations, numbered 0 through 5. Memory location 0 contains the factory default settings, while locations 1-5 are user re-writeable using SYSTem:BOOTstate.

#### Example

:SYST:BOOT 1 *This command specifies state 1 to be loaded upon device powerup.*

#### Default Condition

The factory default setting for SYST:BOOT is 0.

#### Query

:SYST:BOOT? *This query returns a 0 - 5 to indicated the Single Channel RF Downconverter selected boot state.*

- 0 is returned if the selected boot state is 0

#### Error Message

If the parameter is not in the recognized format, error -102, "Syntax error" occurs.

If the parameter is less than 0 or greater than 5, error -222, "Data out of range" occurs.

## 5.2 SYSTem:CURRent?

This command returns the current reading from the Single Channel RF Downconverter in Amps.

### Syntax

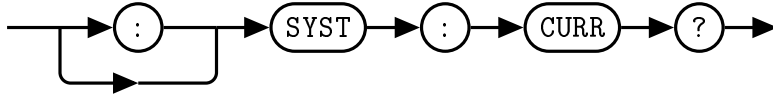

### Query Example

:SYST:CURR? *This query returns the QM1003-0.5-18-1-100-205 current draw in Amps.*

### 5.3 SYSTem:ERRor[:NEXT]?

This query returns error numbers and messages from the QM1003-0.5-18-1-100-205 error queue. When an error is generated by the QM1003-0.5-18-1-100-205, the error number and corresponding error message are stored in the error queue. Each time the error queue is queried, the first error in the error queue is returned. The errors are read out in the order of first-in first-out. To clear all errors in the error queue, use the *\*CLS* command.

When the error queue is empty, a query of the error queue will return a 0, "No error" message. The error queue has a maximum capacity of 10 errors.

The use of the :NEXT token is optional.

#### Syntax

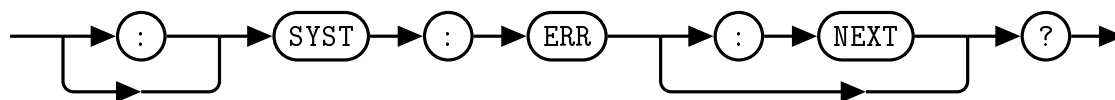

#### Query Example

:SYST:ERR? *Queries the system error.*

#### Error queue messages have the following format:



For example, -102, "Syntax error"

#### Reset Condition

On reset, the error queue is cleared.

#### Error Message List

**Table 4.7:** Error Codes and Messages

-101	Invalid character Invalid character was found in the command string.
-102	Syntax error Invalid syntax was found in the command string.
-103	Invalid separator Invalid separator was found in the command string.
-105	GET not allowed A Group Execute Trigger (GET) is not allowed within a command string.
-108	Parameter not allowed More parameters were received than expected for the command.



-109	Missing parameter Fewer parameters were received than expected for the command.
-112	Program mnemonic too long A command header was received which contained more than the maximum 12 characters allowed.
-113	Undefined header A command was received that is not valid for the Single Channel RF Downconverter.
-121	Invalid character in number An invalid character was found in the number specified for a parameter value.
-123	Exponent too large A numeric parameter was found whose exponent was larger than 32,000.
-124	Too many digits A numeric parameter was found whose mantissa contained more than 255 digits.
-128	Numeric data not allowed A numeric value was received within a command which does not accept a numeric value.
-131	Invalid suffix A unit was incorrectly specified for a numeric parameter.
-134	Suffix too long A unit used contained more than 12 characters.
-138	Suffix not allowed A unit was received following a numeric parameter which does not accept a unit.
-141	Invalid character data An invalid character was received.
-148	Character data not allowed A discrete parameter was received but a character string or numeric parameter was expected.
-151	Invalid string data An invalid string was received.
-158	String data not allowed A character string was received but not allowed for the command.
-161	Invalid block data A block data element was expected but was invalid.
-168	Block data not allowed A legal block data element was encountered but not allowed by the Product.

-178	<p>Expression data not allowed</p> <p>A legal expression data element was encountered but not allowed by the Product.</p>
-200	<p>Execution error</p> <p>Indicates that an execution error has occurred.</p>
-211	<p>Trigger ignored</p> <p>Indicates that a trigger command was received but ignored because the Single Channel RF Downconverter was not in the wait for trigger state.</p>
-213	<p>Trigger ignored</p> <p>Indicates that a trigger command was received but ignored because the Single Channel RF Downconverter was not in the wait for trigger state.</p>
-222	<p>Data out of range</p> <p>A numeric parameter value is outside the valid range for the command.</p>
-224	<p>Illegal parameter value</p> <p>A discrete parameter was received which was not a valid choice for the command.</p>
-230	<p>Data corrupt or stale</p> <p>This occurs when a measurement command is attempted and either a reset has been received or the state of the Single Channel RF Downconverter has changed such that the measurement is no longer valid.</p>
-241	<p>Hardware missing</p> <p>The Single Channel RF Downconverter is unable to execute the command because the hardware does not support that feature.</p>
-310	<p>System error</p> <p>This error indicates a failure with the Single Channel RF Downconverter.</p>
-330	<p>Self-test failed</p> <p>The -330, "Self-test failed" error indicates a problem with the Single Channel RF Downconverter.</p>
-350	<p>Queue overflow</p> <p>The error queue is full and another error has occurred which could not be recorded.</p>
-410	<p>Query INTERRUPTED</p> <p>A command was received which sends data to the output buffer, but the output buffer contained data from a previous command. The output buffer is cleared when power has been off or after a *RST command has been issued.</p>
-420	<p>Query UNTERMINATED</p> <p>The Single Channel RF Downconverter was addressed to talk but a command has not been received which sends data to the output buffer.</p>

-430	Query DEADLOCKED A command was received which generates too much data to fit in the output buffer and the input buffer is also full. Command execution continues but data is lost.
-440	Query UNTERMINATED after indefinite response The *IDN? command must be the last query command within a command string.
+0	No error No errors in the error queue. Device is operating normally.
+110	Invalid Command For Specified Device The issued command is invalid for the specified device.

## 5.4 SYSTem:FIRMware?

This command returns the current PIC and FPGA firmware versions of the Single Channel RF Downconverter.

### Syntax

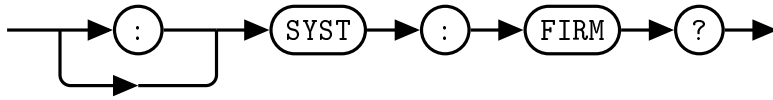

### Query Example

:SYST:FIRM? *This query returns the current firmware versions of the Single Channel RF Downconverter.*

## 5.5 SYSTem:LOADstate [0-5]

This command restores a previously saved state from non-volatile memory. In addition to factory default state 0, there are 5 re-writeable memory locations, specified by choosing an index between 1 and 5. The restored parameters are the *RF Power State*, *External Reference Enabled*, *External LO1 Enabled*, *External LO2 Enabled*, *Tune Frequency*, *Downconverter Mode*, *Downconverter Attenuator 1*, *Downconverter Attenuator 2*, *Downconverter ASR Enabled*. For a detailed description of the parameters saved, see the relevant command descriptions in this manual. When the SYSTem:LOADstate command is called, these parameters will be applied to the device.

### Syntax

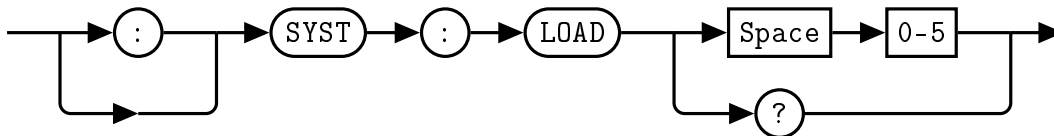

There are 6 memory locations, numbered 0 through 5. Memory location 0 contains the factory default settings, while locations 1-5 are user re-writeable using SYSTem:SAVEstate.

### Example

:SYST:LOAD 4 *This command loads the state 4 parameters from non-volatile memory and applies them to the device.*

### Error Message

If the parameter is not in the recognized format, error -102, "Syntax error" occurs.

If the parameter is less than 0 or greater than 5, error -222, "Data out of range" occurs.

## 5.6 SYSTem:OPTions?

This query returns the installed options used in the Single Channel RF Downconverter. The response is in the format XXX,YYY where XXX is the LO configuration option and YYY is the IF configuration option.

### Syntax

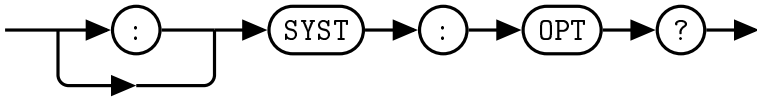

### Query Example

:SYST:OPT? *This query returns the installed options of the Single Channel RF Downconverter.*

## 5.7 SYSTem:READstate? [0-5]

This query allows the user to read the parameters of the stored states without changing any internal registers. The query output is a list of parameters for the selected state. If no state parameter is given, the returned state is state 0. The list of state parameters contains comma separated values, without spaces, in the following order: *RF Power State, External Reference Enabled, External LO1 Enabled, External LO2 Enabled, Tune Frequency, Downconverter Mode, Downconverter Attenuator 1, Downconverter Attenuator 2, Downconverter ASR Enabled*. See the respective command definitions for descriptions of each parameter.

### Syntax

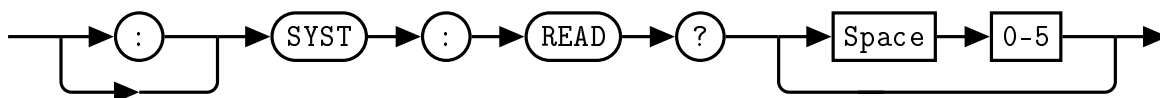

### Query

:SYST:READ? 0 *This query requests the parameter values of state 0.*

**Response:** 0,0,0,0,9.250000,1,0.0,0.0,1,1,0.0,0.0,1

- 0 = POWER:RF is set to 0 or OFF. (page 43)
- 0 = FREQUENCY:REFERENCE:EXTERNAL is set to 0 or Internal. (page 40)
- 0 = FREQUENCY:LO1:EXTERNAL is set to 0 or Internal. (page 36)
- 0 = FREQUENCY:LO2:EXTERNAL is set to 0 or Internal. (page 38)
- 9.250000 = FREQUENCY:TUNE is set to 9.25 GHz. (page 34)
- 1 = FREQUENCY:MODE is set to 1 (downconverter enabled, Input/Output amps off). (page 33)
- 0 = POWER:AT1 is set to 0 dB (page 41)
- 0 = POWER:AT2 is set to 0 dB (page 42)
- 0 = FREQUENCY:ASR is set to 1 (page 31)

### Error Message

If the parameter is not in the recognized format, error -102, "Syntax error" occurs.

If the parameter is less than 0 or greater than 5, error -222, "Data out of range" occurs.

## 5.8 SYSTem:SAVEstate [1-5]

This command saves the current setup to non-volatile memory. There are 5 re-writeable memory locations, specified by choosing an index between 1 and 5. Any of the 5 states can be restored on startup when specified with the SYSTem:BOOTstate command. The parameters saved are the *RF Power State*, *External Reference Enabled*, *External LO1 Enabled*, *External LO2 Enabled*, *Tune Frequency*, *Downconverter Mode*, *Downconverter Attenuator 1*, *Downconverter Attenuator 2*, *Downconverter ASR Enabled*. For a detailed description of the parameters saved, see the relevant command descriptions in this manual. NOTE: The MEM\_CLR button on the back panel will rewrite the contents of states 1-5 with the contents of state 0 when depressed, serving as a reset to factory defaults.

### Syntax

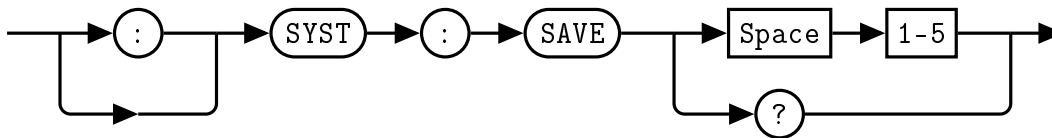

There are 5 memory locations, numbered 1 through 5. Memory location 0 contains the factory default settings and is write-protected.

### Example

:SYST:SAVE 3 *This command saves the current state to memory location 3*

### Error Message

If the parameter is not in the recognized format, error -102, "Syntax error" occurs.

If the parameter is less than 1 or greater than 5, error -222, "Data out of range" occurs.



## 5.9 SYSTem:SERialNUMBER?

This query returns the serial number of the device.

### Syntax

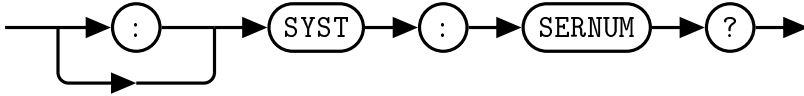

### Query Example

:SYST:SERNUM? *This query returns the serial number of the device.*

## 5.10 SYSTem:USBPID?

This query returns the USB PID of the Single Channel RF Downconverter.

### Syntax

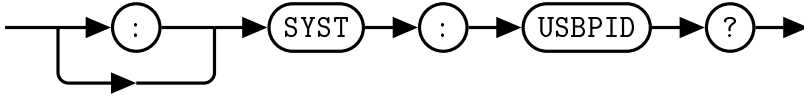

### Query Example

:SYST:USBPID? *This query returns USB PID of the Single Channel RF Downconverter.*

## 5.11 SYSTem:VERSion?

This query returns the version of SCPI used in the Single Channel RF Downconverter. The response is in the format XXXX.Y, where XXXX is the year and Y is the version number.

### Syntax

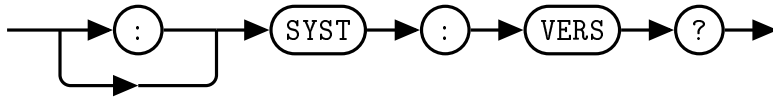

### Query Example

:SYST:VERS? *This query returns the version of SCPI used in the Single Channel RF Downconverter.*

## 6. IEEE 488.2 Command Reference

### 6.1 Introduction

This chapter contains information on the IEEE-488.2 Common Commands that the Single Channel RF Downconverter supports.

The IEEE-488.2 Common Command descriptions are listed below.

**Table 4.8:** IEEE 488.2 Common commands

<i>*CLS</i>	Clear Status	Page 66
<i>*ESE</i> and <i>*ESE?</i>	Event Status Enable	Page 67
<i>*ESR?</i>	Event Status Register	Page 68
<i>*IDN?</i>	Identify	Page 69
<i>*OPC</i> and <i>*OPC?</i>	Operation Complete	Page 70
<i>*RCL</i>	Recall	Page 71
<i>*RST</i>	Reset	Page 72
<i>*SAV</i>	Save	Page 73
<i>*SDS</i>	Save Default Settings	Page 74
<i>*SRE</i> and <i>*SRE?</i>	Service Request Enable	Page 75
<i>*STB?</i>	Status Byte	Page 76
<i>*TST?</i>	Test	Page 77
<i>*WAI</i>	Wait	Page 78

## 6.2 \*CLS

The \*CLS (CLear Status) command clears the data structures. The SCPI registers are all cleared.

### Syntax

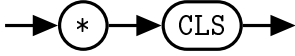

### 6.3 \*ESE <NRf>

The \*ESE (Event Status Enable) command sets the Standard Event Status Enable Register. This register contains a mask value for the bits to be enabled in the Standard Event Status Register. A 1 in the enable register enables the corresponding bit in the Status Register, a 0 disables the corresponding bit in the Status Register. The parameter value when expressed in base 2, represents the bit values of the Standard Event Status Enable Register. Table 4.9 shows the contents of this register.

**Table 4.9: \*ESE bit mapping**

Bit	Base 2	Meaning
0	1	Operation Complete
1	2	Request Control (not used)
2	4	Query Error
3	8	Device Dependent Error
4	16	Execution Error
5	32	Command Error
6	64	Not Used
7	128	Power On

#### Syntax

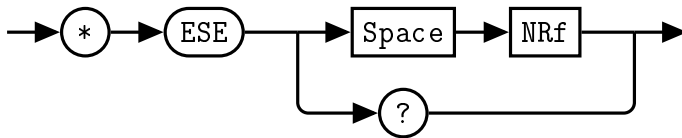

#### Allowed Values

The *NRf* parameter can be any integer in the range of 0 to 255.

#### Query

\*ESE? *This query returns the contents of the Standard Event Status Enable Register.*

#### Error Message

If the parameter is not in the recognized format, error -102, "Syntax error" occurs.

If the parameter is less than 0 or greater than 255, error -222, "Data out of range" occurs.

## 6.4 \*ESR?

The *\*ESR?* query returns the contents of the Standard Event Status Register then clears it. The returned value is in the range of 0 to 255. Table 4.10 shows the contents of this register.

**Table 4.10:** \*ESR? mapping

Bit	Base 2	Meaning
0	1	Operation Complete
1	2	Not Used
2	4	Query Error
3	8	Device Dependent Error
4	16	Execution Error
5	32	Command Error
6	64	Not Used
7	128	Power On

### Syntax



## 6.5 \*IDN?

The *\*IDN?* query allows the connected device to identify itself. The string returned is:

*Quonset Microwave,<Product Number>,<Serial Number>,<Firmware>*

where:

- *<Product Number>* identifies the product number of the host
- *<Serial Number>* uniquely identifies the host
- *<Firmware>* returns the firmware of the host

### Syntax





## 6.6 \*OPC

The *\*OPC* (Operation Complete) command causes the QM1003-0.5-18-1-100-205 Single Channel RF Downconverter to set the operation complete bit in the Standard Event Status Register when all pending device operations have been completed.

**Table 4.11: \*OPC mapping**

Bit	Base 2	Meaning
0	1	Operation Complete
1	2	Not Used
2	4	Query Error
3	8	Device Dependent Error
4	16	Execution Error
5	32	Command Error
6	64	Not Used
7	128	Power On

### Syntax

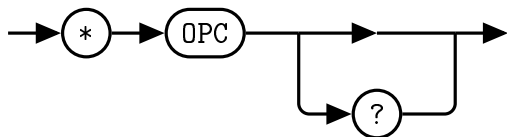

### Query

*\*OPC?* This query places a 1 in the output queue when all device operations have been completed.

## 6.7 \*RCL <NRf>

The \*RCL (ReCaLI) command restores a previously saved state from non-volatile memory. In addition to factory default state 0, there are 5 re-writable memory locations, specified by choosing an index between 1 and 5. The restored parameters are the *RF Power State*, *External Reference Enabled*, *External LO1 Enabled*, *External LO2 Enabled*, *Tune Frequency*, *Downconverter Mode*, *Downconverter Attenuator 1*, *Downconverter Attenuator 2*, *Downconverter ASR Enabled*. For a detailed description of the parameters saved, see the relevant command descriptions in this manual. When the \*RCL command is called, these parameters will be applied to the device.

### Syntax

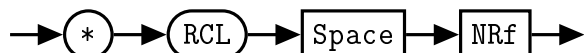

### Allowed Values

The *NRf* parameter can be any integer in the range of 0 to 5.

### Error Message

If the parameter is not in the recognized format, error -102, "Syntax error" occurs.

If the parameter is less than 0 or greater than 5, error -222, "Data out of range" occurs.

## 6.8 \*RST

The *\*RST* (ReSeT) command returns the QM1003-0.5-18-1-100-205 Single Channel RF Downconverter to its initial power-up state.

### Syntax

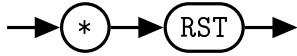

## 6.9 \*SAV <NRf>

The \*SAV (SAVe) command saves the current setup to non-volatile memory. There are 5 re-writeable memory locations, specified by choosing an index between 1 and 5. Any of the 5 states can be restored on startup when specified with the SYSTem:BOOTstate command. The parameters saved are the *RF Power State, External Reference Enabled, External LO1 Enabled, External LO2 Enabled, Tune Frequency, Downconverter Mode, Downconverter Attenuator 1, Downconverter Attenuator 2, Downconverter ASR Enabled*. For a detailed description of the parameters saved, see the relevant command descriptions in this manual. NOTE: The MEM\_CLR button on the back panel will rewrite the contents of states 1-5 with the contents of state 0 when depressed, serving as a reset to factory defaults.

### Syntax

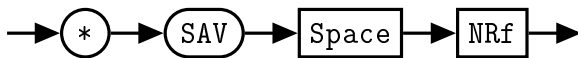

### Allowed Values

The *NRf* parameter can be any integer in the range of 1 to 5.

### Error Message

If the parameter is not in the recognized format, error -102, "Syntax error" occurs.

If the parameter is less than 1 or greater than 5, error -222, "Data out of range" occurs.

## 6.10 \*SDS <NRf>

The \*SDS (Save Default device Settings) command restores the specified state of the QM1003-0.5-18-1-100-205 Single Channel RF Downconverter to the default state settings. There are 5 re-writeable memory locations, specified by choosing an index between 1 and 5. The parameters restored are the *RF Power State*, *External Reference Enabled*, *External LO1 Enabled*, *External LO2 Enabled*, *Tune Frequency*, *Downconverter Mode*, *Downconverter Attenuator 1*, *Downconverter Attenuator 2*, *Downconverter ASR Enabled*. For a detailed description of the parameters saved, see the relevant command descriptions in this manual. Issuing this command does not change the current settings. NOTE: The MEM\_CLR button on the back panel will rewrite the contents of states 1-5 with the contents of state 0 when depressed, serving as a reset to factory defaults.

### Syntax

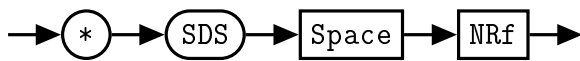

### Allowed Values

The *NRf* parameter can be any integer in the range of 1 to 5.

### Error Message

If the parameter is not in the recognized format, error -102, "Syntax error" occurs.

If the parameter is less than 1 or greater than 5, error -222, "Data out of range" occurs.

### 6.11 \*SRE <NRf>

The \*SRE command sets the Service Request Enable register bits. This register contains a mask value for the bits to be enabled in the Status Byte Register. A 1 in the enable register enables the corresponding bit in the Status Register, a 0 disables the corresponding bit in the Status Register. The parameter value when expressed in base 2, represents bits 0 to 5 and bit 7 of the Service Request Enable Register. Bit 6 is not used and is always 0. Table 4.12 shows the contents of this register.

**Table 4.12: \*SRE bit mapping**

Bit	Base 2	Meaning
0	1	Not used
1	2	Not Used (not used)
2	4	Device Dependent
3	8	Questionable Status Summary
4	16	Message Available
5	32	Event Status Bit
6	64	Not Used
7	128	Operation Status Summary

#### Syntax

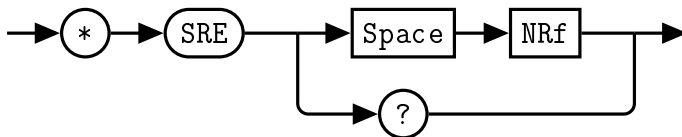

#### Allowed Values

The *NRf* parameter can be any integer in the range of 0 to 255.

#### Query

\*SRE? *This query returns the contents of bits 0 to 5 and bit 7 of the Service Request Enable Register. Bit 6 is always 0.*

#### Error Message

If the parameter is not in the recognized format, error -102, "Syntax error" occurs.

If the parameter is less than 0 or greater than 255, error -222, "Data out of range" occurs.

## 6.12 \*STB?

The *\*STB?* (S**T**atus **B**yte) query returns bit 0 to 5 and bit 7 of the QM1003-0.5-18-1-100-205 Single Channel RF Downconverter status byte and returns the Master Summary Status (MSS) as bit 6. The MSS is inclusive OR of the bitwise combination (excluding bit 6) of the Status Byte and the Service Request Enable registers. The format of the return is an integer between 0 and 255. Table 4.13 shows the contents of this register.

**Table 4.13:** \*STB? mapping

Bit	Base 2	Meaning
0	1	Not used
1	2	Device Dependent 0 - No device status condition has occurred 1 - A device status condition has occurred
2	4	Error/Event Queue 0 = Queue empty 1 = Queue not empty
3	8	Questionable Status Summary 0 - No <b>Q</b> UESTionable status conditions have occurred 1 - A <b>Q</b> UESTionable status condition has occurred
4	16	Message Available 0 - no output messages are ready 1 - an output message is ready
5	32	Event Status Bit 0 - no event status has occurred 1 - an event status condition has occurred
6	64	Master Summary Status 0 - Single Channel RF Downconverter not requesting service 1 - there is at least one reason for requesting service
7	128	Operation Status Summary 0 = No <b>O</b> PERation status conditions have occurred 1 = An <b>O</b> PERation status condition has occurred

### Syntax



### 6.13 \*TST?

The *\*TST?* query causes the QM1003-0.5-18-1-100-205 Single Channel RF Downconverter to perform a self-test. The result of the self-test is placed in the output queue.

- 0 is returned if the test passes

#### Syntax





## 6.14 \*WAI

The *\*WAI* (WAI) command causes the QM1003-0.5-18-1-100-205 Single Channel RF Downconverter to wait until either:

- All pending operations are complete
- The *Device Clear* command is received
- Power is cycled

before executing any subsequent commands or queries.

### Syntax

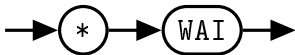



# 5 Windows Control GUI

## In This Chapter

1. Overview . . . . .	80
-----------------------	----

## 1. Overview

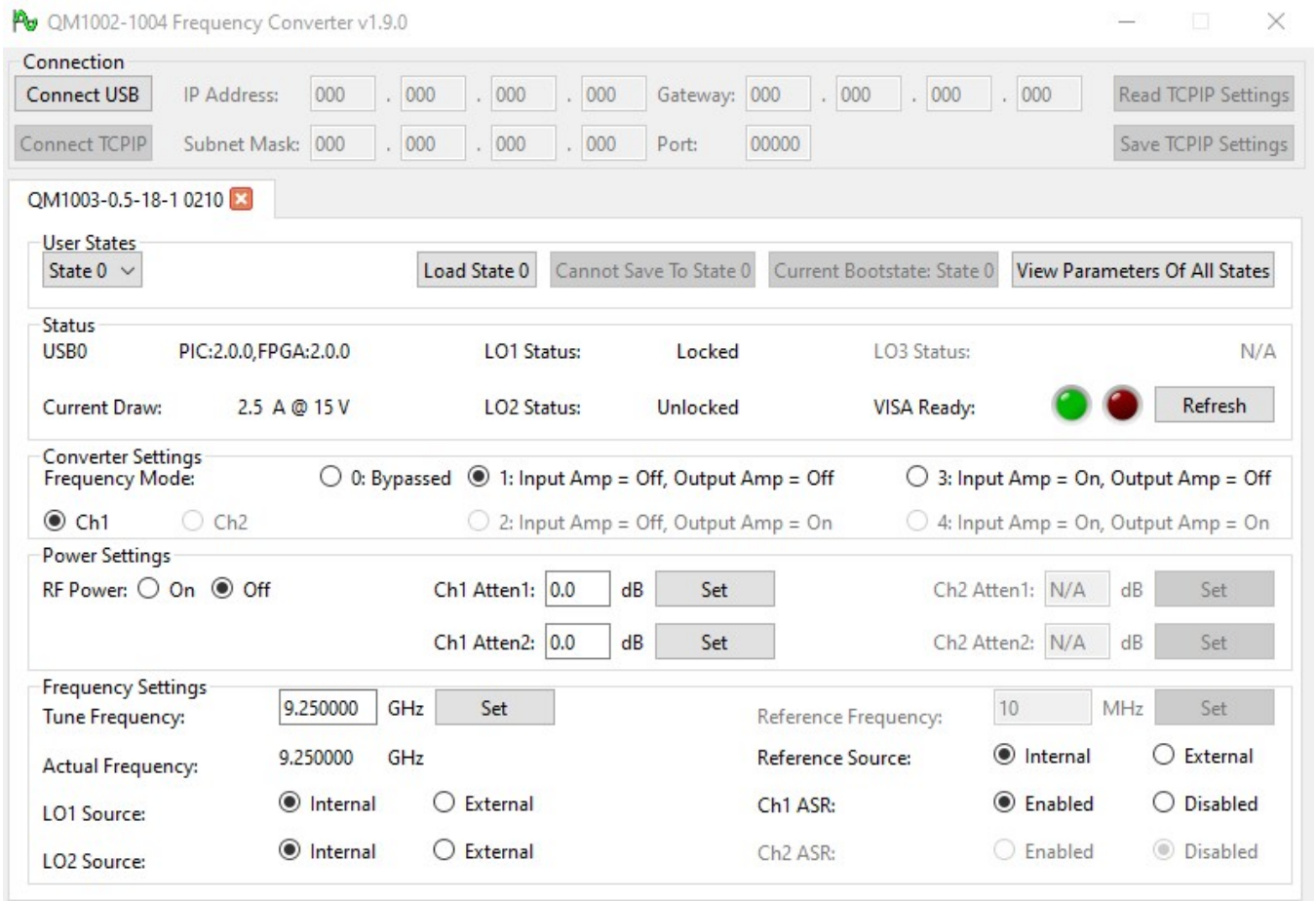

**Figure 5.1:** Windows® Control GUI

The Graphical User Interface (GUI) for the QM1003-0.5-18-1-100-205 is shown above in Figure 5.1. This GUI provides the current status and provides all of the essential functionality for the Single Channel RF Downconverter system. The GUI allows the user to toggle RF power, and to set the converter mode, user states, attenuation control, tune the device, and change reference settings.

The GUI for QM1002-1004 products is currently in the process of being combined into a common GUI to control all family devices. Currently supported hardware includes:

- QM1003-0.5-18-1-100-201
- QM1003-0.5-18-1-100-205-ELP-RFPass
- QM1003-0.5-18-2-100-205-ELP-RFPass
- QM1004-0.5-18-100-200
- QM1004-0.5-18-100-204

- QM1004-0.5-18-100-205-ELP-RFPass
- QM1004-0.5-18-100-206-10MHz-50C

# Index

## Control Commands, 26

- FREQUency:ASR, 31
- FREQUency:LO1:EXTernal, 36
- FREQUency:LO1:LOCK, 37
- FREQUency:LO2:EXTernal, 38
- FREQUency:LO2:LOCK, 39
- FREQUency:LOCK, 32
- FREQUency:MODE, 33
- FREQUency:REFerence:EXTernal, 40
- FREQUency:TUNE, 34
- FREQUency:TUNErACTual, 35
- POWER:AT1, 41
- POWER:AT2, 42
- POWER:RF, 43
- STATus:OPERation, 44
- STATus:OPERation:CONDition, 45
- STATus:OPERation:ENABle, 46
- STATus:OPERation:QUESTionable, 49
- STATus:PRESet, 47
- STATus:QUESTionable, 48
- STATus:QUESTionable:ENABle, 50
- SYSTem:BOOTSTATE, 51
- SYSTem:CURRent, 52
- SYSTem:ERRor, 53
- SYSTem:FIRMware, 57
- SYSTem:LOADstate, 58
- SYSTem:OPTions, 59
- SYSTem:READstate, 60
- SYSTem:SAVE, 61
- SYSTem:SERialNUMBER, 62
- SYSTem:USBPID, 63
- SYSTem:VERSion, 64

## Default Units, 20

## Firmware Updates, 6

- FPGA Firmware Updates, 8
- FTP Location, 7
- Introduction, 7
- PIC Firmware Updates, 16

## FREQUency Subsystem Command Reference

- FREQUency:ASR, 31
- FREQUency:LO1:EXTernal, 36
- FREQUency:LO1:LOCK, 37
- FREQUency:LO2:EXTernal, 38
- FREQUency:LO2:LOCK, 39
- FREQUency:LOCK, 32
- FREQUency:MODE, 33
- FREQUency:REFerence:EXTernal, 40
- FREQUency:TUNE, 34
- FREQUency:TUNErACTual, 35

## General Description, 4

## General Safety Information, iii

## IEEE 488.2 Command Reference, 65

- \*CLS, 66
- \*ESE, 67
- \*ESR?, 68
- \*IDN?, 69
- \*OPC, 70
- \*RCL, 71
- \*RST, 72
- \*SAV, 73
- \*SDS, 74
- \*SRE, 75
- \*STB?, 76
- \*TST?, 77
- \*WAI, 78

## Input/Output Specifications, 3

## Notices, i

## Overview, 2

## POWER Subsystem Command Reference

- POWER:AT1, 41
- POWER:AT2, 42
- POWER:RF, 43

## Product Safety, ii

## Remote Operation, 17

- Introduction, 19
  - Command Syntax, 19
  - Compliance Information, 23
  - Default Units, 20
  - Diagram Syntax Conventions, 19
  - Input Message Terminators, 23
  - SCPI Data Types, 20
  - Status Reporting, 20
  - USB, 19
- VISA Descriptors and Configuration, 25
  - USB, 25

#### STATUS Subsystem Command Reference

- STATus:OPERation, 44
- STATus:OPERation:CONDition, 45
- STATus:OPERation:ENABle, 46
- STATus:OPERation:QUEStionable, 49
- STATus:PRESet, 47
- STATus:QUEStionable, 48
- STATus:QUEStionable:ENABle, 50

#### System Block Diagram, 5

#### SYSTEM Subsystem Command Reference

- SYSTem:BOOTSTATE, 51
- SYSTem:CURRent, 52
- SYSTem:ERRor, 53
- SYSTem:FIRMware, 57
- SYSTem:LOADstate, 58
- SYSTem:OPTions, 59
- SYSTem:READstate, 60
- SYSTem:SAVE, 61
- SYSTem:SERialNUMBER, 62
- SYSTem:USBPID, 63
- SYSTem:VERSion, 64

#### Windows Control GUI, 79

- Overview, 80



**Quonset Microwave**  
[www.quonsetmicrowave.com](http://www.quonsetmicrowave.com)



1003-004-21 Revision 3.0.0, September 2023