



Quonset Microwave
www.quonsetmicrowave.com

QM1004-8-12-100
Combined RF Upconverter/Downconverter
Option 100: Internal Common LOs

User Manual
Revision 2.0.0, June 2021

Notices

© 2021 Quonset Microwave

No part of this manual may be reproduced in any form or by any means (including electronic storage and retrieval or translation into a foreign language) without prior permission and written consent from Quonset Microwave as governed by United States and international copyright laws.

Manual Part Number

1004-009-21

Edition

Revision 2.0.0, June 2021

Printed in the USA

Quonset Microwave

315 Commerce Park Road

Unit 3

North Kingstown, RI 02852 USA

Warranty

The material contained in this document is provided "as is," and is subject to be changed, without notice, in future editions. Further, to the maximum extent permitted by applicable law, Quonset Microwave disclaims all warranties, either expressed or implied, with regard to this manual and any information contained herein, including but not limited to the implied warranties of merchantability and fitness for a particular purpose. Quonset Microwave shall not be liable for errors or incidental or consequential damages in connection with the furnishing, use, or performance of this document or of any information contained herein. Should Quonset Microwave and the user have a separate written agreement with warranty terms covering the material in this document that conflict with these terms, the warranty terms in the separate agreement shall control.

Technology Licenses

The hardware and/or software described in this document are furnished under a license and may be used or copied only in accordance with the terms of such license.

Restricted Rights Legend

U.S. Government Restricted Rights. Software and technical data rights granted to the federal government include only those rights customarily provided to end user customers.

Quonset Microwave provides this customary commercial license in Software and technical data pursuant to FAR 12.211 (Technical Data) and 12.212 (Computer Software) and, for the Department of Defense, DFARS 252.227-7015 (Technical Data - Commercial Items) and DFARS 227.7202-3 (Rights in Commercial Computer Software or Computer Software Documentation).

Safety Notices

CAUTION

A **CAUTION** notice denotes a hazard. It calls attention to an operating procedure, practice, or the like that, if not correctly performed or adhered to, could result in damage to the product or loss of data. Do not proceed beyond a **CAUTION** notice until the indicated conditions are fully understood and met.

WARNING

A **WARNING** notice denotes a hazard. It calls attention to an operating procedure, practice, or the like that, if not correctly performed or adhered to, could result in personal injury or death. Do not proceed beyond a **WARNING** notice until the indicated conditions are fully understood and met.

Restricted Rights Legend

The Software and Documentation have been developed entirely at private expense. They are delivered and licensed as "commercial computer software" as defined in DFARS 252.227-7013 (Oct 1988), DFARS 252.211-7015 (May 1991), or DFARS 252.227-7014 (Jun 1995), as a "commercial item" as defined in FAR 2.101(a) or as "restricted computer software" as defined in FAR 25.227-19 (Jun 1987) (or any equivalent agency regulation or contract clause), whichever is applicable. The End User has only those rights provided for such Software and Documentation by the applicable FAR or DFARS clause or the Quonset Microwave standard software agreement for the product involved.

General Warranty

The material contained in this document is provided "as is," and is subjected to being changed, without notice, in future editions. Further, to the maximum extent permitted by applicable law, Quonset Microwave disclaims all warranties, either expressed or implied with regard to this manual and any information contained herein, including but not limited to the implied warranties of merchantability and fitness for a particular purpose. Quonset Microwave shall not be liable for errors or for incidental or consequential damages in connection with the furnishing, use, or performance of this document or any information contained herein. Should Quonset Microwave and the user have a separate written agreement with warranty terms covering the material in this document that conflict with these terms, the warranty terms in the separate agreement shall control. Duration and conditions of warranty for this product may be superseded when the product is integrated into (becomes part of) other Quonset Microwave products. During the warranty period, Quonset Microwave will, at its option, either repair or replace products which prove to be defective. The warranty period begins on the date of delivery or on the date of installation if installed by Quonset Microwave.

Product Safety

The following general safety precautions must be observed during all phases of operation of this device. Failure to comply with these precautions or with specific warnings elsewhere in this manual violates safety standards of design, manufacture, and intended use of this device. Quonset Microwave assumes no liability for the customer's failure to comply with these requirements.

Safety Notices

CAUTION

A **CAUTION** notice denotes a hazard. It calls attention to an operating procedure, practice, or the like that, if not correctly performed or adhered to, could result in damage to the product or loss of data. Do not proceed beyond a **CAUTION** notice until the indicated conditions are fully understood and met.

WARNING

A **WARNING** notice denotes a hazard. It calls attention to an operating procedure, practice, or the likes that, if not correctly performed or adhered to, could result in personal injury or death. Do not proceed beyond a **WARNING** notice until the indicated conditions are fully understood and met.

Personal Safety Considerations

This is a Safety Class I product (provided with a protective earthing ground incorporated in the power cord). The mains plug shall only be inserted in a socket outlet provided with a protective earth contact. Any interruption of the protective conductor, inside or outside the product, is likely to make the product dangerous. Intentional interruption is prohibited. If this product is not used as specified, the protection provided by the equipment could be impaired. This product must be used in a normal condition (in which all means of protection are intact) only.

No operator serviceable parts inside. Refer servicing to qualified personnel. To prevent electrical shock, do not remove covers. For continued protection against fire hazard, replace the line fuse(s) only with fuses of the same type and rating (for example, normal blow, time delay, etc.). The use of other fuses or material is prohibited.

General Safety Information

The following general safety precautions must be observed during all phases of operation of this product. Failure to comply with these precautions or with specific warnings elsewhere in this manual or any manual associated with this product violates safety standards of design, manufacture, and intended use of the product. Quonset Microwave assumes no liability for the customer's failure to comply with these requirements.

WARNING

BEFORE APPLYING POWER TO THIS PRODUCT OR MAKING ANY CONNECTIONS TO THIS PRODUCT ensure that all instruments are connected to the protective (earth) ground. Any interruption of the protective earth grounding will cause a potential shock hazard that could result in personal injury or death.

CAUTION

- Use this device with the cables provided.
 - Do not attempt to service this device. This device should be returned to Quonset Microwave for any service or repairs.
 - Do not open the device.
-

User Environment

This instrument is designed for *indoor* use only.

Markings

The following markings may appear on the equipment or in any related documentation.



This marking indicates that a device, or part of a device, may be susceptible to electrostatic discharges (ESD) which can result in damage to the product. Observed ESD precautions given on the product, or in its user documentation, when handling equipment bearing this mark.



This marking indicates that the device complies with applicable sections of part 15 of the FCC rules.



This marking indicates that the device conforms with applicable EC directives.



This marking indicates that the device complies with the Virtual Instrument Software Architecture (VISA) specification.



This marking indicates that the device complies with the Standard Commands for Programmable Instrumentation (SCPI) specification.



This marking indicates that the device complies with the USB Test & Measurement Class (USB TMC) and the USB 488 subclass specifications.



This marking indicates that the device communicates over the Universal Serial Bus (USB).



This marking indicates that the device communicates over Ethernet.

Revision Control

Revision	Description of Changes	Date
2.0.0	Initial Release	06/03/2021

Contents

Notices	i
Manual Part Number	i
Edition	i
Warranty	i
Technology Licenses	i
Restricted Rights Legend	i
Safety Notices	i
Restricted Rights Legend	ii
General Warranty	ii
Product Safety	ii
Safety Notices	ii
Personal Safety Considerations	iii
General Safety Information	iii
User Environment	iii
Markings	iv
Revision Control	v
1 Overview	2
1. Input/Output Specifications	3
2. General Description	5
3. System Block Diagram	6
2 Firmware Updates	8
1. Introduction	9
2. Firmware Update Files	9
3. PIC Firmware Updates	10
3 Remote Operation	11
1. Introduction	13
1.1 USB Configuration	13
1.2 Command Syntax	13
1.2.1 Mnemonic Forms	13
1.2.2 Using a Semicolon(;)	13
1.2.3 Using Whitespace	13
1.2.4 Using "?" Commands	13
1.2.5 Using "*" Commands	13
1.3 Diagram Syntax Conventions	13
1.4 Default Units	14
1.5 Status Reporting	14
1.6 SCPI Data Types	14

1.6.1	<boolean> Definition	14
1.6.2	<character_data> Definition	15
1.6.3	<NAN> Definition	15
1.6.4	<non-decimal numeric> Definition	15
1.6.5	<NRf> Definition	15
1.6.6	<NR1> Definition	15
1.6.7	<NR2> Definition	15
1.6.8	<NR3> Definition	16
1.6.9	<numeric_value> Definition	16
1.6.10	<string> Definition	16
1.7	Input Message Terminators	17
1.8	Compliance Information	17
1.8.1	IEEE-488.2 Compliance	17
1.8.2	USBTMC Compliance	17
1.8.3	VISA Compliance	18
2.	VISA Descriptors and Configuration	19
2.1	USBTMC	19
2.1.1	VISA Descriptors	19
2.1.2	USBTMC VISA Code Example	19
4	Control Commands	20
1.	Command Quick Reference Guide	22
1.1	Common (*) Commands	22
1.2	FREQuency Subsystem	23
1.3	POWER Subsystem	23
1.4	STATUs Subsystem	24
1.5	SYSTEM Subsystem	24
2.	FREQuency Subsystem Command Reference	25
2.1	FREQuency:LO1:DIVider	25
2.2	FREQuency:LO1:EXTernal	26
2.3	FREQuency:LO1:LOCK	27
2.4	FREQuency:LO1:PLLMode	28
2.5	FREQuency:LO2:EXTernal	30
2.6	FREQuency:LO2:LOCK	31
2.7	FREQuency:LOCK	32
2.8	FREQuency:REFerence:EXTernal	33
2.9	FREQuency:REFerence:FREQuency	34
2.10	FREQuency:REFerence:LOCK	35
2.11	FREQuency:TUNE	36
2.12	FREQuency:TUNErACTual	37
3.	POWER Subsystem Command Reference	38
3.1	POWER:CH1:ATTENUation	38
3.2	POWER:CH2:ATTENUation	39
3.3	POWER:LNA	40
3.4	POWER:RF	41
4.	STATUs Subsystem Command Reference	42

4.1	STATus:OPERation	42
4.2	STATus:OPERation:CONDition	43
4.3	STATus:OPERation:ENABLE	44
4.4	STATus:PRESet	45
4.5	STATus:QUEStionable	46
4.6	STATus:QUEStionable:CONDition	47
4.7	STATus:QUEStionable:ENABLE	48
5.	SYSTem Subsystem Command Reference	49
5.1	SYSTem:BOOTstate	49
5.2	SYSTem:CURRent	50
5.3	SYSTem:ERRor	51
5.4	SYSTem:FIRMware	55
5.5	SYSTem:LOADstate	56
5.6	SYSTem:READstate	57
5.7	SYSTem:SAVEstate	58
5.8	SYSTem:SERialNUMBER	59
5.9	SYSTem:USBPID	60
5.10	SYSTem:VERSion	61
6.	IEEE 488.2 Command Reference	62
6.1	Introduction	62
6.2	*CLS	63
6.3	*ESE <NRf>	64
6.4	*ESR?	65
6.5	*IDN?	66
6.6	*OPC	67
6.7	*RCL <NRf>	68
6.8	*RST	69
6.9	*SAV <NRf>	70
6.10	*SDS <NRf>	71
6.11	*SRE <NRf>	72
6.12	*STB?	73
6.13	*TST?	74
6.14	*WAI	75
5	Windows Control GUI	76
1.	Overview	77
	Index	77

List of Tables

1.1	Input Specifications	3
1.2	Output Specifications	4
2.1	PIC Firmware Revision History	9
3.2	Default Units	14
4.1	Common (*) Commands Summary	22
4.2	FREQUency Subsystem Commands Summary	23
4.3	POWER Subsystem Commands Summary	23
4.4	STATus Subsystem Commands Summary	24
4.5	SYSTem Subsystem Commands Summary	24
4.6	Comparison between Integer and Fractional PLL modes	28
4.7	Error Codes and Messages	51
4.8	IEEE 488.2 Common commands	62
4.9	*ESE bit mapping	64
4.10	*ESR? mapping	65
4.11	*OPC mapping	67
4.12	*SRE bit mapping	72
4.13	*STB? mapping	73

List of Figures

1.1	QM1004-8-12-100 Combined RF Upconverter/Downconverter system	5
1.2	QM1004-8-12-110 Upconverter Block Diagram	6
1.3	QM1004-8-12-110 Downconverter Block Diagram	6
2.1	CCSLOAD: PIC Programming	10
5.1	Windows® Control GUI	77



1 Overview

In This Chapter

1. Input/Output Specifications	3
2. General Description	5
3. System Block Diagram	6

1. Input/Output Specifications

Table 1.1: Input Specifications

Parameter	Min	Typ	Max	Unit
External CMOS Reference Input				
Frequency	10		250	MHz
Power Level			3.3	Vp-p
External LO1 Input				
Frequency	12.9		16.4	GHz
Power Level		1	20	dBm
External LO2 Input				
Frequency		5.65		GHz
Power Level		5	20	dBm
Upconverter IF Input				
Frequency	750		1250	MHz
Power Level (absolute maximum)				
LNA On			23	dBm
LNA Off			26	dBm
Downconverter RF Input				
Frequency	8		12	GHz
Power Level (absolute maximum)			20	dBm

Table 1.2: Output Specifications

Parameter	Min	Typ	Max	Unit
LO1 Output Frequency Power Level	12.9		16.4	GHz dBm
LO2 Output Frequency Power Level		5.65 2		GHz dBm
100 MHz Reference Output Frequency Power Level Type: Sine Wave		100	500	MHz mVp-p
10 MHz Reference Output Frequency Power Level Type: Square Wave		10	550	MHz mVp-p
Upconverter RF Output @ 0 dB attenuation Frequency Gain: LNA On Gain: LNA Off Maximum Output Power Level	8		12	GHz dB dB dBm
Downconverter IF Output @ 8 dB (minimum) attenuation Frequency Gain Maximum Output Power Level	750		1250	MHz dB dBm

2. General Description

The QM1004-8-12-100 is a Combined RF Upconverter/Downconverter housed in a 1U box. The QM1004-8-12-100 is controlled either through the onboard USB or TCP/IP connection. The QM1004-8-12-100 delivery kit contains a user manual, Windows Control GUI, power supply, and USB A-A cable. A model of the QM1004-8-12-100 is shown below in Fig. 1.1.



Figure 1.1: QM1004-8-12-100 Combined RF Upconverter/Downconverter system

The QM1004-8-12-100 Combined RF Upconverter/Downconverter has been equipped with Option -110, which adds two independent Local Oscillator (LO) sources, making the QM1004-8-12-100 a self-contained system, requiring only the externally applied RF or IF signals for proper operation. The Local Oscillators (LOs) in the QM1004-8-12-100 are locked to a common internal 100 MHz reference. The user has the option of supplying their own reference through the BNC connector located on the back panel of the QM1004-8-12-100.

3. System Block Diagram

Block diagrams for the QM1004-8-12-100 Combined RF Upconverter/Downconverter are shown in Figures 1.2 and 1.3. Internal attenuators in the upconverter and downconverter blocks are controlled digitally via a microcontroller, which interfaces to a PC through USB or TCP/IP. The microcontroller outputs basic status messages on a 32-character Liquid Crystal Display (LCD) mounted on the faceplate of the unit. An internal 100 MHz reference clock is phase-locked to all of the internal LOs, with a BNC-F connector providing the option for LOs to lock to a user-provided 10-250 MHz external reference. Two additional BNC-F connectors output an internally-generated 10 MHz and 100 MHz reference for use by external test equipment. Switching between the internal and external LO reference clocks is controlled either by the microcontroller or a reference selector switch. The 12.9-16.4 GHz LO1 and 5.65 GHz LO2 outputs are provided for external phase locking, multi-channel or MIMO applications, and diagnostic purposes.

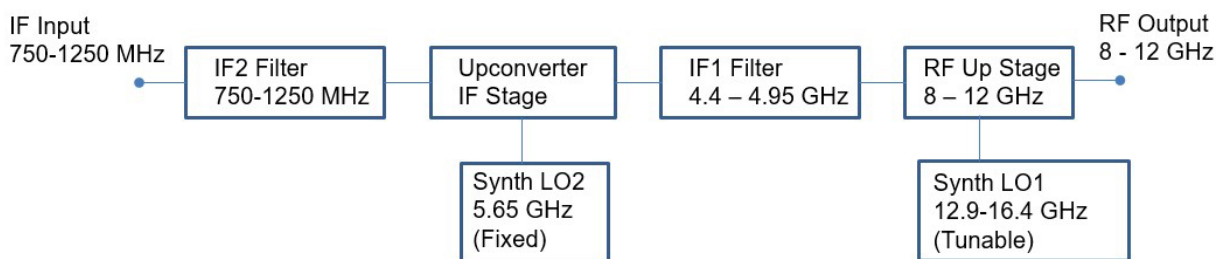

Figure 1.2: QM1004-8-12-110 Upconverter Block Diagram

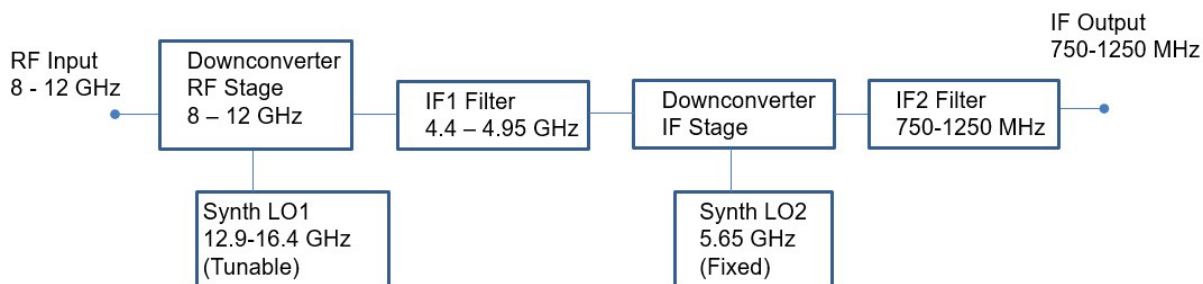

Figure 1.3: QM1004-8-12-110 Downconverter Block Diagram

The QM1004-8-12-110 uses a two-stage high-side conversion, as illustrated in Figure 1.3. As with any frequency conversion architecture, spurious signals (or spurs) will appear in the output on both upconversion and downconversion as a result of the frequency mixing process. This issue is particularly prevalent on upconversion, because the RF output has a wide frequency range (8-12 GHz) compared to downconversion (0.75 - 1.25 GHz).

In the QM1004-8-12-110 design, the largest in-band spur occurs at 9.3 GHz for a 1.0 GHz input tone. For a -10 dBm input with upconversion LNA ON, this spur occurs at around -30 dBc. The spur level is lowered (non-linearly) by lowering the input signal. This 9.3 GHz spur, which moves ± 250 MHz as the input frequency is varied from 0.75 - 1.25 GHz, is exactly 2x the IF1 center frequency of 4.65 GHz. The

RF Up Stage mixer simply passes the 2x IF directly to the output. Because this signal is "in-band", there is no amount of filtering that can get rid of this spur without changing the frequency plan, including the IF1 filter and fixed LO2. The only way this spur may be reduced in the current design is by either lowering the input IF signal power, by lowering the LO2 power (consult factory for details), or by adjusting the RF tunable filter in the RF Up Stage (consult factory).

The second source of spurs in the upconversion is the direct LO1 leakage in the RF output. Due to the fact that the LO1 power is typically much higher than the IF1 input, direct leakage of LO1 through the RF Up Stage mixer is unavoidable. Fortunately, the LO1 leakage is out of band, and may be filtered with an external lowpass or bandpass filter.

Harmonics of the RF upconversion output are also present. Fortunately, these also are out of band, and may be filtered out.



2 Firmware Updates

In This Chapter

1. Introduction	9
2. Firmware Update Files	9
3. PIC Firmware Updates	10

1. Introduction

The QM1004-8-12-100 Combined RF Upconverter/Downconverter is continually being improved and may require firmware updates to correct problems in previous firmware versions or to add new features that were not yet implemented in previous firmware versions. Table 2.1 details Firmware Revisions that have been released and which features they fixed or introduced.

Table 2.1: PIC Firmware Revision History

PIC Firmware Version	Reason To Update
v1.0.0	N/A (Initial Release)

2. Firmware Update Files

The required files to perform firmware updates are uploaded onto the Quonset Microwave FTP server and need to be downloaded and extracted to a location on the computer performing the update prior to continuing.

Firmware updates can be obtained by clicking the following link and navigating to the download link in the Software tab:

<http://www.quonsetmicrowave.com/QM1004-8-12-p/qm1004-8-12.htm>

The zip files contain the necessary *.hex files required to perform the PIC firmware updates.

3. PIC Firmware Updates

The QM1004-8-12-100 Control Board uses a Microchip Technology, Inc. PIC18F67J50 processor. The PIC Firmware update process is performed using a Custom Computer Services, Inc. (CCS) ICD-U64 Debugger/Programmer, but can be done using any In-Circuit Serial Programmer (ICSP) with an RJ-12 connection that supports the Microchip PIC18F67J50 device. The ICD-U64 from CCS includes the CCSLOAD free programmer control software, which is used to load the update.

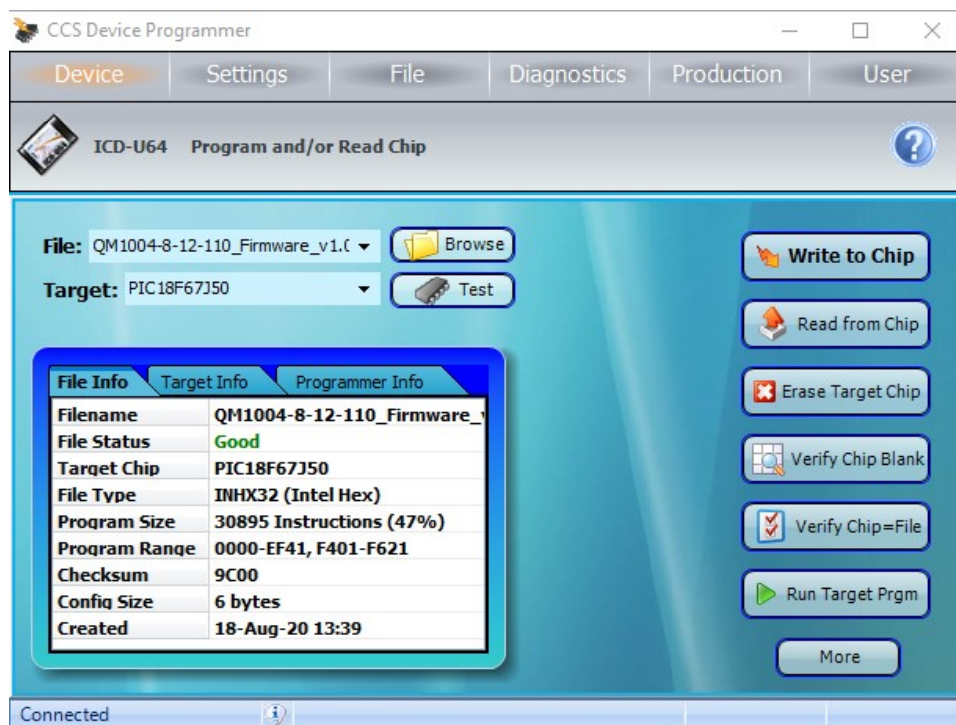

Figure 2.1: CCSLOAD: PIC Programming

After opening CCSLOAD, simply click 'Browse' and select the QM1004-8-12-110_v1.0.0.hex file and click 'Write to Chip'. When complete, the status in the bottom left will change from 'Connected' to 'Target Programmed'. After programming, either close CCSLOAD or click 'Run Target Prgm' to run the new version.



3 Remote Operation

In This Chapter

1.	Introduction	13
1.1	USB Configuration	13
1.2	Command Syntax	13
1.2.1	Mnemonic Forms	13
1.2.2	Using a Semicolon(;)	13
1.2.3	Using Whitespace	13
1.2.4	Using "?" Commands	13
1.2.5	Using "*" Commands	13
1.3	Diagram Syntax Conventions	13
1.4	Default Units	14
1.5	Status Reporting	14
1.6	SCPI Data Types	14
1.6.1	<boolean> Definition	14
1.6.2	<character_data> Definition	15
1.6.3	<NAN> Definition	15
1.6.4	<non-decimal numeric> Definition	15
1.6.5	<NRf> Definition	15
1.6.6	<NR1> Definition	15
1.6.7	<NR2> Definition	15
1.6.8	<NR3> Definition	16
1.6.9	<numeric_value> Definition	16
1.6.10	<string> Definition	16
1.7	Input Message Terminators	17
1.8	Compliance Information	17
1.8.1	IEEE-488.2 Compliance	17
1.8.2	USBTMC Compliance	17

1.8.3 VISA Compliance 18

2. VISA Descriptors and Configuration 19

2.1 USBTMC 19

2.1.1 VISA Descriptors 19

2.1.2 USBTMC VISA Code Example 19

The following markings apply to the QM1004-8-12-100 Combined RF Upconverter/-Downconverter family of products.

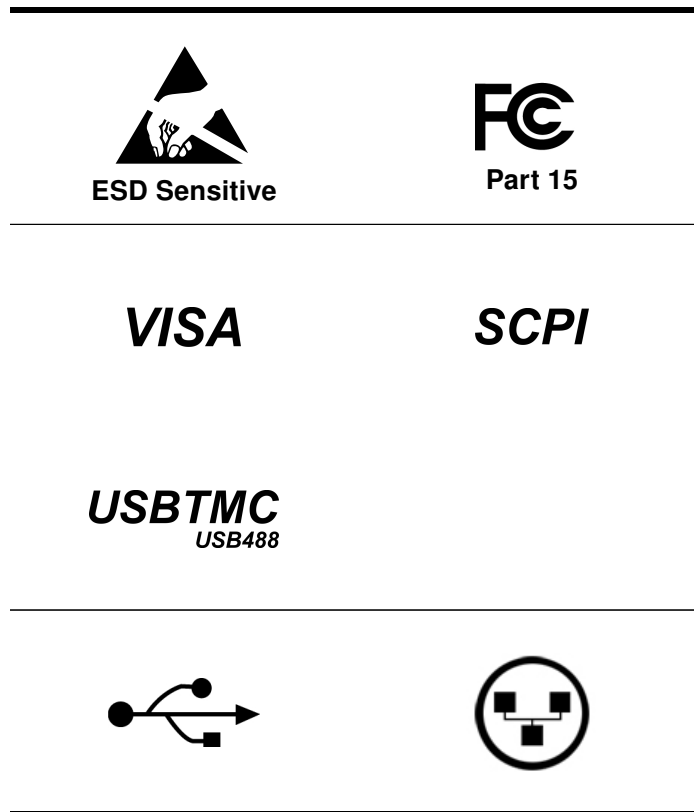

1. Introduction

1.1 USB Configuration

The Quonset Microwave QM1004-8-12-100 Combined RF Upconverter/Downconverter has been designed to configure as a USBTMC or TCPIP device. No additional drivers are required.

The QM1004-8-12-100 has been designed to be VISA and SCPI compliant and as such, all you need in order to communicate with the Combined RF Upconverter/Downconverter is a VISA library installed on your machine. The QM1004-8-12-100 has been designed using the NI-VISA Runtime Engine, which is included with the GUI.

1.2 Command Syntax

In this manual, the following command syntax conventions are used:

- Square brackets ([]) indicate multiple keywords, one of which must be used
- Bars(|) can be read as "or" and are used to separate parameter options.

1.2.1 Mnemonic Forms

Each keyword has both a long and short form. A standard notation is used to differentiate the short form and long form keyword. The long form of the keyword is shown, with the short form of the keyword shown in uppercase letters and the rest of the keyword is shown in lowercase letters. For example, the short form of *FREQuency* is *FREQ*.

1.2.2 Using a Semicolon(;)

Use a semicolon to separate two commands within the same command string.

1.2.3 Using Whitespace

You *must* use whitespace characters, [tab], or [space] to separate a parameter from a keyword.

1.2.4 Using "?" Commands

The bus controller may send commands at any time, but a SCPI instrument may only send a response when specifically instructed to do so. Only commands that end with a "?", henceforth referred to as queries, instruct the instrument to send a response message. Queries can return either measured values, instrument settings, or internal status codes.

Note: *If you send multiple queries without reading the response between queries, only the result of the last query will be returned when the response is read. The query buffer is a first-in first-out configuration.*

1.2.5 Using "*" Commands

Commands starting with a "*" are called common commands. They are required to perform identical functions for all instruments that are compliant with the IEEE-488.2 interface standard. The "*" commands are used to control reset, self-test, and status operations in the Combined RF Upconverter/Downconverter.

1.3 Diagram Syntax Conventions

- Solid lines represent the recommended path
- Ovals enclose command mnemonics. The command mnemonic must be entered exactly as shown in the oval.
- Dotted lines indicate an optional path for passing secondary or optional keywords.

- Arrows and curved intersections indicate command path direction.
- All diagrams flow from left to right. A path may not travel to the left except in a bypass loop.

1.4 Default Units

Unless otherwise specified, the following units are assumed:

Table 3.2: Default Units

Current	A
Frequency	GHz
Power	dBm
Time	μ s
Temperature	°C
Voltage	Volts

1.5 Status Reporting

Status reporting is used to monitor the Combined RF Upconverter/Downconverter to determine which events have occurred. Status reporting is accomplished by configuring and reading status registers.

The Combined RF Upconverter/Downconverter has the following main registers:

- Status Register
- Standard Event Register
- Operation Status Register
- Questionable Status Register
- Device Status Register

Status and Standard Event registers are read using the IEEE-488.2 common commands.

Operation and Questionable Status registers are read using the SCPI *STAT* subsystem.

1.6 SCPI Data Types

The SCPI language defines different formats for use in program messages and response messages. Instruments are flexible listeners and can accept commands and parameters in various formats. However, SCPI instruments are precise talkers. This means that SCPI instruments *always* responds to a particular query in a predefined, rigid format.

1.6.1 <boolean> Definition

Throughout this document <*boolean*> is used to represent *ON|OFF|<NRf>*. Boolean parameters have a value of *0* or *1* and are unitless. *ON* corresponds to *1* and *OFF* corresponds to *0*.

On input, an <NRf> is rounded to an integer. A nonzero result is interpreted as *1*.

Queries always return a *1* or a *0*, never *ON* or *OFF*.

1.6.2 <character_data> Definition

Throughout this document, <character_data> is used to represent character data, that is, A-Z, a-z, 0-9 and _ (underscore). STOP and A4_U2 are examples of character data. The first character must be alphanumeric, followed by either alphanumeric or underscore characters up to a maximum of 12 characters.

1.6.3 <NAN> Definition

Not a number (NAN) is represented as 9.91 E37. Not a number is defined in IEEE 754.

1.6.4 <non-decimal numeric> Definition

Throughout this document, <non-decimal numeric> is used to represent numeric information in bases other than 10 (that is, hexadecimal, octal, and binary). Examples of non-decimal numeric include #HFF4, #hff4, #Q25, #q25, and #B101011.

1.6.5 <NRf> Definition

Throughout this document, <NRf> is used to denote a flexible numeric representation. The following show examples of <NRf>

- +185
- -10
- +1.2E09

1.6.6 <NR1> Definition

Throughout this document, <NR1> numeric response data is defined as:

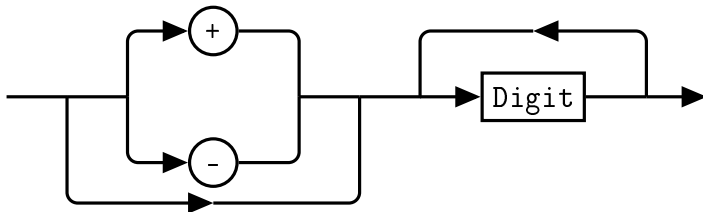

The following shows the examples of <NR1>:

- 127
- +127
- -12345

1.6.7 <NR2> Definition

Throughout this document, <NR2> numeric response data is defined as:

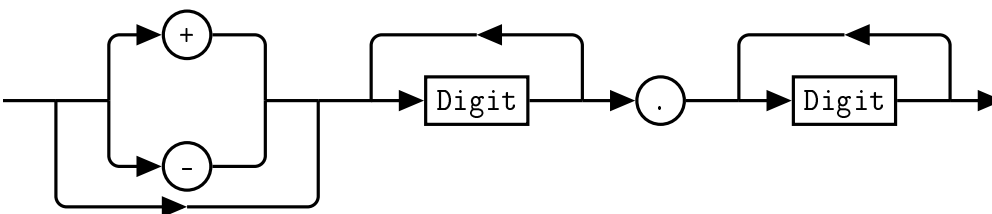

The following shows the examples of <NR2>:

- 12.7
- +127
- -1.2345
- -0.123

1.6.8 <NR3> Definition

Throughout this document, <NR3> numeric response data is defined as:

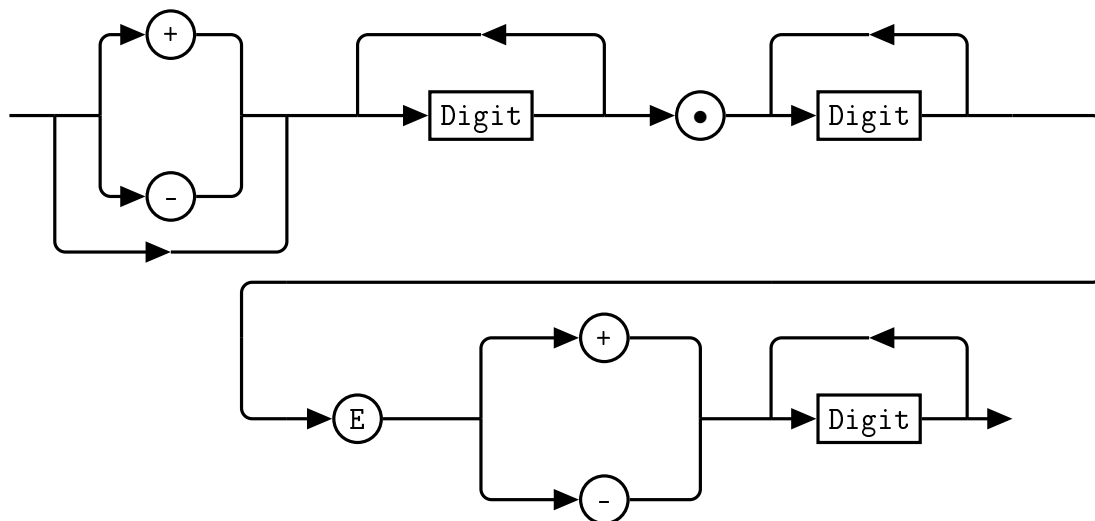

The following shows the examples of <NR3>:

- 1.23E+4
- 12.3E-45

1.6.9 <numeric_value> Definition

Throughout this document, the decimal numeric element is abbreviated to <numeric_value>.

1.6.10 <string> Definition

Throughout this document, <string> is used to represent the 7-bit ASCII characters. The format is defined as:

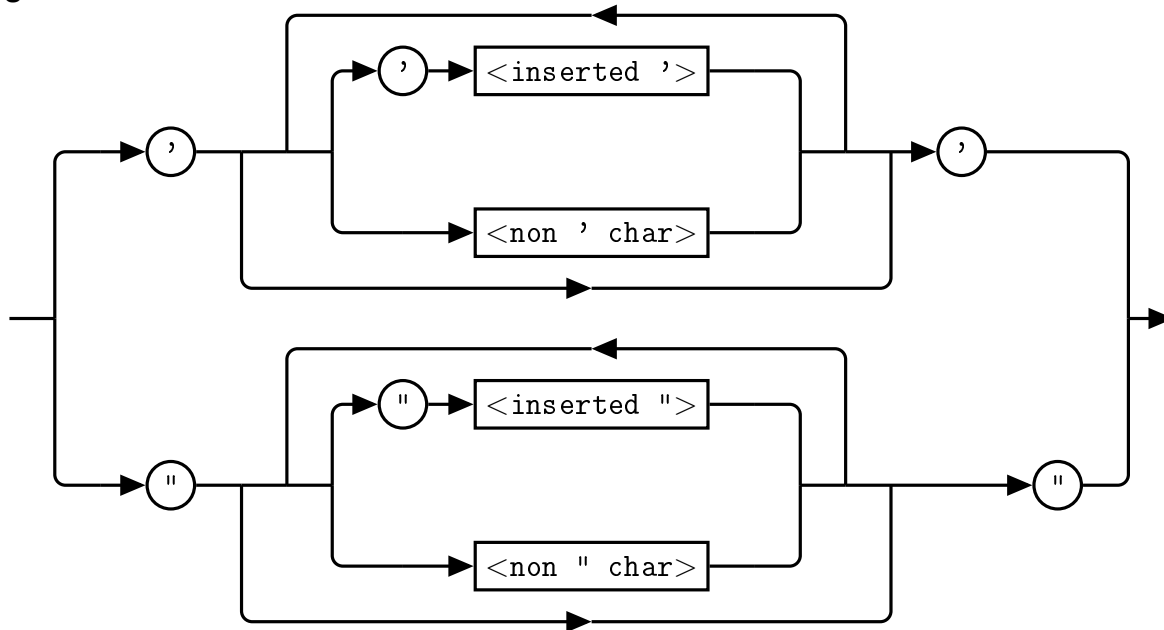
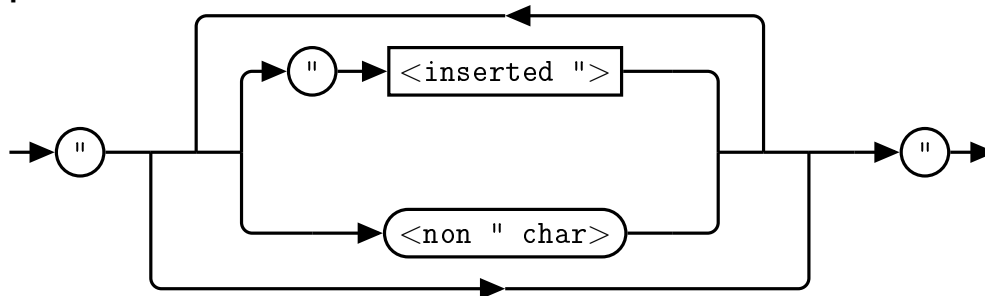
Program Data**Response Data****1.7 Input Message Terminators**

Program messages sent to a SCPI instrument *must* terminate with a <newline> character. The IEEE.488 EOI (end or identify) signal is interpreted as a <newline> character and may also be used to terminate a message in place of the <newline> character. A <carriage return> followed by a <newline> character is also accepted. Many programming languages allow you to specify a message terminator character or EOI state to be automatically sent with each bus transaction. Message termination *always* sets the current path back to the root-level.

1.8 Compliance Information**1.8.1 IEEE-488.2 Compliance**

The Combined RF Upconverter/Downconverter complies with the rules and regulations of the of the IEEE-488.2 standard which are applicable to USB controlled devices.

1.8.2 USBTMC Compliance

The QM1004-8-12-100 Combined RF Upconverter/Downconverter complies with the rules and regulations of the of the USBTMC (USB Test and Measurement Class). When connected to a USB bus, the QM1004-8-12-100 will configure as a USB Test and Measurement device.

1.8.3 VISA Compliance

The QM1004-8-12-100 Combined RF Upconverter/Downconverter complies with the rules and regulations of the VISA (Virtual Instrument Systems Architecture) standard. Communication with the QM1004-8-12-100 is accomplished through VISA libraries, providing portability between different operating systems. *No additional drivers are required.*

2. VISA Descriptors and Configuration

2.1 USBTMC

2.1.1 VISA Descriptors

To communicate with the Quonset Microwave QM1004-8-12-100 Combined RF Upconverter/Downconverter as a USBTMC device, use the following USB VISA descriptor format:

```
USB[board number]::manufacturer ID::model code::serial number::INSTR
```

Descriptor Example

```
USB0::0x2012::0x001F::0001::INSTR
```

2.1.2 USBTMC VISA Code Example

```
ViSession rscmng;  
ViSession qm1004;  
char buf[256] = 0;  
  
viOpenDefaultRM(&rscmng);  
viOpen(rscmng,(ViRsrc)"USB0::0x2012::0x001F::0001::INSTR",VI_NULL,VI_NULL,&qm1004);  
viPrintf(qm1004,(ViString)"*IDN?\n");  
viScanf(qm1004,(ViString)"%t",&buf);  
viClose((ViObject)qm1004);  
viClose((ViObject)rscmng);
```



4 Control Commands

In This Chapter

- 1. Command Quick Reference Guide 22
 - 1.1 Common (*) Commands 22
 - 1.2 FREQUENCY Subsystem 23
 - 1.3 POWER Subsystem 23
 - 1.4 STATUS Subsystem 24
 - 1.5 SYSTEM Subsystem 24
- 2. FREQUENCY Subsystem Command Reference 25
 - 2.1 FREQUENCY:LO1:DIVider 25
 - 2.2 FREQUENCY:LO1:EXTernal 26
 - 2.3 FREQUENCY:LO1:LOCK 27
 - 2.4 FREQUENCY:LO1:PLLMode 28
 - 2.5 FREQUENCY:LO2:EXTernal 30
 - 2.6 FREQUENCY:LO2:LOCK 31
 - 2.7 FREQUENCY:LOCK 32
 - 2.8 FREQUENCY:REFerence:EXTernal 33
 - 2.9 FREQUENCY:REFerence:FREQUENCY 34
 - 2.10 FREQUENCY:REFerence:LOCK 35
 - 2.11 FREQUENCY:TUNE 36
 - 2.12 FREQUENCY:TUNERACTual 37
- 3. POWER Subsystem Command Reference 38
 - 3.1 POWER:CH1:ATTENUation 38
 - 3.2 POWER:CH2:ATTENUation 39
 - 3.3 POWER:LNA 40
 - 3.4 POWER:RF 41
- 4. STATUS Subsystem Command Reference 42
 - 4.1 STATUS:OPERation 42

4.2	STATus:OPERation:CONDition	43
4.3	STATus:OPERation:ENABle	44
4.4	STATus:PRESet	45
4.5	STATus:QUEStionable	46
4.6	STATus:QUEStionable:CONDition	47
4.7	STATus:QUEStionable:ENABle	48
5.	SYSTem Subsystem Command Reference	49
5.1	SYSTem:BOOTstate	49
5.2	SYSTem:CURRent	50
5.3	SYSTem:ERRor	51
5.4	SYSTem:FIRMware	55
5.5	SYSTem:LOADstate	56
5.6	SYSTem:READstate	57
5.7	SYSTem:SAVEstate	58
5.8	SYSTem:SERialNUMber	59
5.9	SYSTem:USBPID	60
5.10	SYSTem:VERSion	61
6.	IEEE 488.2 Command Reference	62
6.1	Introduction	62
6.2	*CLS	63
6.3	*ESE <NRf>	64
6.4	*ESR?	65
6.5	*IDN?	66
6.6	*OPC	67
6.7	*RCL <NRf>	68
6.8	*RST	69
6.9	*SAV <NRf>	70
6.10	*SDS <NRf>	71
6.11	*SRE <NRf>	72
6.12	*STB?	73
6.13	*TST?	74
6.14	*WAI	75

1. Command Quick Reference Guide

1.1 Common (*) Commands

Table 4.1: Common (*) Commands Summary

Command	Page	Description
*CLS	63	Clears the data structures. The SCPI registers are cleared.
*ESE <NRf>	64	Sets the Standard Event Status Enable Register.
*ESE?	64	Returns the Standard Event Status Enable Register.
*ESR?	65	Returns the contents of the Standard Event Status Register and then clears it.
*IDN?	66	Returns the identification of the device connected to the computer (Host).
*OPC	67	Causes the Combined RF Upconverter/Downconverter to set the operation complete bit in the Standard Event Status Register when all pending operations have completed.
*OPC?	67	Returns the operation complete bit in the Standard Event Status Register when all pending operations have completed.
*RCL <NRf>	68	Recalls the settings of the Combined RF Upconverter/Downconverter from the specified register (memory location).
*RST	69	Returns the Combined RF Upconverter/Downconverter to its initial power up state.
*SAV <NRf>	70	Saves the settings of the Combined RF Upconverter/Downconverter to the specified register (memory location).
*SDS <NRf>	71	Saves the default settings of the Combined RF Upconverter/Downconverter to the specified register (memory location).
*SRE <NRf>	72	Sets the Service Request Enable register bits.
*SRE?	72	Returns the Service Request Enable register bits.
*STB?	73	Returns the Combined RF Upconverter/Downconverter status byte.
*TST?	74	Performs a self-test and returns the result.
*WAI	75	Causes the Combined RF Upconverter/Downconverter to wait until either all pending commands are complete, the Device Clear command is received, or the power is cycled before executing any subsequent commands or queries.

1.2 FREQUENCY Subsystem

Table 4.2: FREQUENCY Subsystem Commands Summary

Command	Page	Description
FREQUENCY:LO1:DIVider	25	Sets or Returns the reference divider of the LO1s for both channels.
FREQUENCY:LO1:EXTernal	26	Sets or Returns whether the internal or external supplied LO1 local oscillator is used for both channels.
FREQUENCY:LO1:LOCK	27	Returns the lock status of the internal LO1s for both channels.
FREQUENCY:LO1:PLLMode	28	Sets or Returns the PLL Mode (<i>Integer</i> or <i>Fractional</i>) of the internal LO1 for both channels.
FREQUENCY:LO2:EXTernal	30	Sets or Returns whether the internal or external supplied LO2 local oscillator is used for both channels.
FREQUENCY:LO2:LOCK	31	Returns the lock status of the internal LO2 for the system.
FREQUENCY:LOCK	32	Returns the lock status of the internal LOs for both channels.
FREQUENCY:REFerence:EXTernal	33	Sets or Returns whether the internal or external supplied reference oscillator is used.
FREQUENCY:REFerence:FREQUENCY	34	Sets or Returns the reference frequency when using an externally-supplied reference.
FREQUENCY:REFerence:LOCK	35	Returns the lock status for the incoming external reference signal and the outgoing references.
FREQUENCY:TUNE	36	Sets or Returns the desired tuning frequency in GHz for both channels.
FREQUENCY:TUNERACTual	37	Returns the actual tuning frequency in GHz for both channels.

1.3 POWER Subsystem

Table 4.3: POWER Subsystem Commands Summary

Command	Page	Description
POWER:CH1:ATTENUation	38	Sets or Returns the value of RF attenuation for channel 1 (upconverter).
POWER:CH2:ATTENUation	39	Sets or Returns the value of RF attenuation for channel 2 (downconverter).
POWER:LNA	40	Turns on or off the upconverter LNA gain stage of the device.

POWER:RF	41	Turns on or off the RF output of the device.
----------	----	--

1.4 STATus Subsystem

Table 4.4: STATus Subsystem Commands Summary

Command	Page	Description
STATus:OPERation	42	Returns the contents of the status event register.
STATus:OPERation:CONDition	43	Returns the contents of the condition register.
STATus:OPERation:ENABLE	44	Sets the enable bit mask for the status event register.
STATus:PRESet	45	Presets the STATus:QUEStionable:ENABLE register.
STATus:QUEStionable	46	Returns the contents of the questionable register.
STATus:QUEStionable:CONDition	47	Returns the contents of the questionable condition register.
STATus:QUEStionable:ENABLE	48	Sets the enable bit mask for the questionable register.

1.5 SYSTem Subsystem

Table 4.5: SYSTem Subsystem Commands Summary

Command	Page	Description
SYSTem:BOOTstate	49	Sets or Returns the device boot state to load at startup.
SYSTem:CURRent	50	Returns the current draw of the device.
SYSTem:ERRor	51	Returns error numbers and messages from the error queue.
SYSTem:FIRMware	55	Returns the current firmware version of the device.
SYSTem:LOADstate	56	Loads and sets the parameters from the specified state.
SYSTem:READstate	57	Reads the parameters from the stored state without changing the current device setup.
SYSTem:SAVEstate	58	Saves the current parameters to a specified state number.
SYSTem:SERialNUMBER	59	Returns the serial number of the device.
SYSTem:USBPID	60	Returns the USB Product ID of the device.
SYSTem:VERSion	61	Returns the version of SCPI implemented in the Combined RF Upconverter/Downconverter.

2. FREquency Subsystem Command Reference

2.1 FREquency:LO1:DIVider <numeric value>

This command allows the user to set the QM1004-8-12-100 LO1 reference divider value for both channels. The allowed values are integers between 1 and 16383. The reference divider is used to set the resolution of the tune frequency step size while operating in integer mode. The frequency step size in integer mode is $\frac{f_{ref}}{N} * prescaler$. In the QM1004-8-12-100, the *reference frequency* (f_{ref}) is fixed at 100 MHz and the hardware *prescaler* is fixed at 4. This results in the integer mode tuning resolution being $\frac{400}{N}$, where N is the reference divider value. It is recommended to use a divider of 1 when operating in fractional mode.

Note: Phase noise will increase as the reference divider value increases.

Syntax

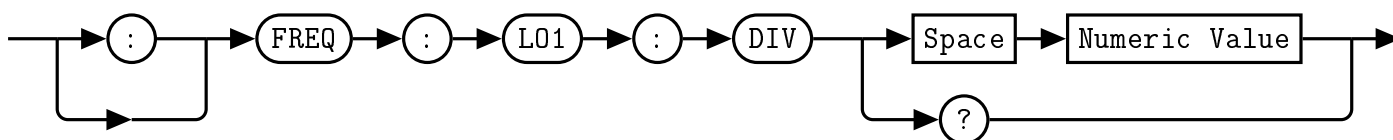

Example

:FREQ:LO1:DIV 2

This command sets the LO reference divider of the QM1004-8-12-100 to 2.

Default Condition

On power up, or when a *RST command is issued, the QM1004-8-12-100 LO reference divider returns to the boot state's setting. The Combined RF Upconverter/Downconverter default setting is 1.

Query

:FREQ:LO1:DIV? *This query returns the value of the QM1004-8-12-100 LO reference divider.*

Error Message

If the parameter is not in the recognized format, error -102, "Syntax error" occurs.

If the parameter is not between 10 and 250, error -222, "Data out of range" occurs.

2.2 FREQuency:LO1:EXTeRnal [1|0]

This command allows the user to select between the internal LO1 local oscillators and externally supplied ones for both channels. Issuing this command overrides the back panel toggle switch settings for both channels.

When *0* is specified, the internal LO1 local oscillators are used by the Combined RF Upconverter/Downconverter.

When *1* is specified, the external LO1 inputs are used by the Combined RF Upconverter/Downconverter.

Syntax

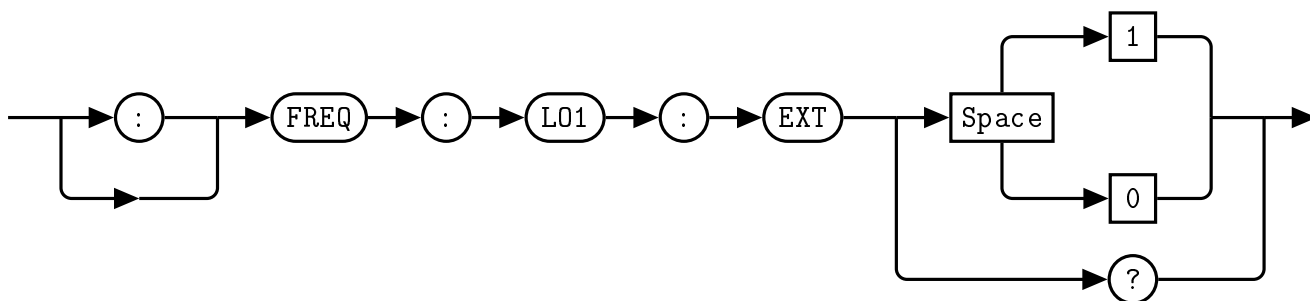

Example

:FREQ:LO1:EXT 0 *This command selects the internal LO1 oscillators.*

Default Condition

On power up, or when a *RST command is issued, the QM1004-8-12-100 returns to the boot state's setting. The Combined RF Upconverter/Downconverter default setting is 0.

Query

:FREQ:LO1:EXT? *This query returns a 0 or 1 to indicate the selected Combined RF Upconverter/Downconverter oscillator source.*

- 0 is returned if the internal LO1 oscillators are selected
- 1 is returned if the external LO1s are selected

Error Message

If the parameter is not in the recognized format, error -102, "Syntax error" occurs.

If the parameter is not 1 or 0, error -222, "Data out of range" occurs.

2.3 FREQuency:LO1:LOCK

This query allows the user to check the lock status of the internal LOs to the reference signal for both channels.

Syntax

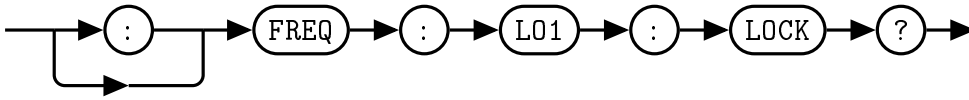

Query

:FREQ:LO1:LOCK? *This query returns the lock status of the internal LOs. A lock status of 0 indicates that the LOs are unlocked, while a lock status of 1 indicates the LOs are locked.*

2.4 FREQUENCY:LO1:PLLMODE [INT|FRAC|1|0]

This command sets the PLL mode of the tunable Local Oscillator (LO1) located inside the QM1004-8-12-100 for both channels. A PLL mode of *INT* or *1* indicates that the PLL is operating in Integer mode, while a PLL mode of *FRAC* or *0* indicates that the PLL is operating in Fractional Mode.

When the PLL is placed in *Integer* mode (also referred to as *Integer-N* mode), the output frequency is an integer multiple of the reference oscillator frequency, divided by the reference divider, multiplied by the hardware prescaler. The QM1004-8-12-100 has a fixed hardware prescaler of 4 and a reference frequency of 100 MHz. With the reference divider set to 1, the frequency resolution of FREQUENCY:TUNE is 400 MHz. This means that 10.15 GHz and 10.55 GHz would both be tunable frequencies, as the corresponding LO frequencies (14.8 GHz and 15.2 GHz) are divisible by 400 MHz, but 10.35 GHz would not be tunable with the default LO1 reference divider as the corresponding LO frequency (15 GHz) is not divisible by 400 MHz. The user can manipulate the frequency step size in integer mode by changing the reference divider. By increasing the reference divider value to 2, the tuneable frequency step size becomes 200 MHz, making 10.35 GHz a tunable frequency. While increasing the reference divider value decreases the tunable frequency step size, phase noise performance is degraded.

When the PLL is placed in *Fractional* mode, the tuneable frequency can be tuned with a resolution of 100 kHz. In the above example, the synthesizer would be capable of outputting a frequency of 10.0001 GHz when operated in *Fractional* mode. When operating in fractional mode, the reference divider should always be 1 for best phase noise performance.

Table 4.6 summarizes the advantages and disadvantages of the two synthesizer operational modes.

Table 4.6: Comparison between Integer and Fractional PLL modes

Mode	Advantages	Disadvantages
Integer	Lower Phase Noise	Frequency must be an integer multiple of $\frac{f_{ref}}{N} * prescaler$, where $f_{ref} = 100$ and $prescaler = 4$ for the QM1004-8-12-100.
Fractional	Can tune in 100 kHz frequency steps	Increased Phase Noise Increased spurious products

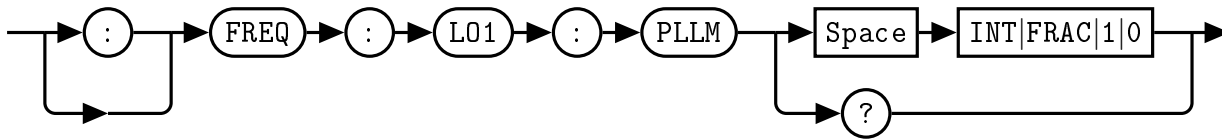
Syntax**Example**

:FREQ:LO1:PLLM 1 *This command sets the PLL mode of the QM1004-8-12-100 to Integer mode.*

Default Condition

On power up, or when a *RST command is issued, the QM1004-8-12-100 PLL mode setting returns to the boot state's setting. The Combined RF Upconverter/Downconverter default setting is 1.

Query

:FREQ:LO1:PLLM? *This query returns the PLL mode of the QM1004-8-12-100*

- 0 is returned if the synthesizers are Fractional Mode
- 1 is returned if the synthesizers are in Integer Mode

2.5 FREQuency:LO2:EXTeRnal [1|0]

This command allows the user to select between the internal LO2 local oscillator and an externally supplied one for both channels. Issuing this command overrides the back panel toggle switch setting.

When *0* is specified, the internal LO2 local oscillator is used by the Combined RF Upconverter/Downconverter.

When *1* is specified, the external LO2 input is used by the Combined RF Upconverter/Downconverter.

Syntax

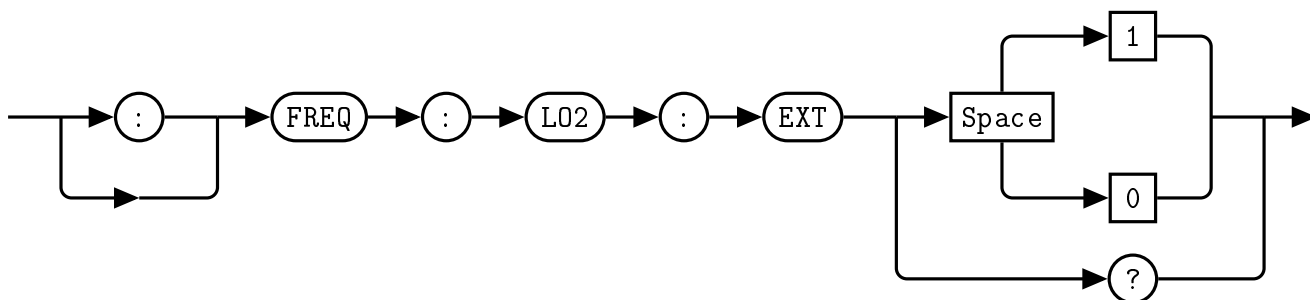

Example

`:FREQ:LO2:EXT 0` *This command selects the internal LO2 oscillator.*

Default Condition

On power up, or when a **RST* command is issued, the QM1004-8-12-100 returns to the boot state's setting. The Combined RF Upconverter/Downconverter default setting is 0.

Query

`:FREQ:LO2:EXT?` *This query returns a 0 or 1 to indicate the selected Combined RF Upconverter/Downconverter reference mode*

- 0 is returned if the internal LO2 oscillator is selected
- 1 is returned if the external LO2 is selected

Error Message

If the parameter is not in the recognized format, error *-102*, "Syntax error" occurs.

If the parameter is not 1 or 0, error *-222*, "Data out of range" occurs.

2.6 FREQuency:LO2:LOCK

This query allows the user to check the lock status of the internal LO2 to the reference signal for the Combined RF Upconverter/Downconverter.

Syntax

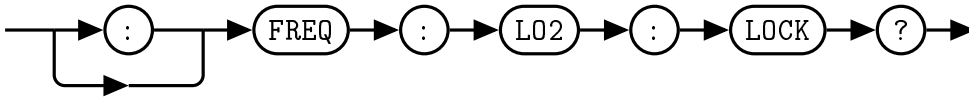

Query

:FREQ:LO2:LOCK? *This query returns the lock status of the internal LO2. A lock status of 0 indicates that the LO2 is unlocked, while a lock status of 1 indicates the LO2 is locked.*

2.7 FREQuency:LOCK

This query allows the user to check the lock status of the internal LOs to the reference signal for the Combined RF Upconverter/Downconverter.

Syntax

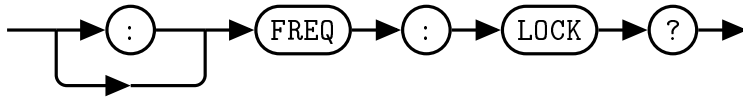

Query

`:FREQ:LOCK?` *This query returns the lock status of the internal LOs. A lock status of 0 indicates that the LOs are unlocked, while a lock status of 1 indicates the LOs are locked.*

2.8 FREQuency:REFerence:EXTernal [1|0]

This command allows the user to select between the internal 100 MHz reference and an externally supplied reference. Issuing this command overrides the back panel toggle switch setting.

When *0* is specified, the internal reference oscillator is used by the Combined RF Upconverter/Downconverter.

When *1* is specified, the external reference input is used by the Combined RF Upconverter/Downconverter.

Syntax

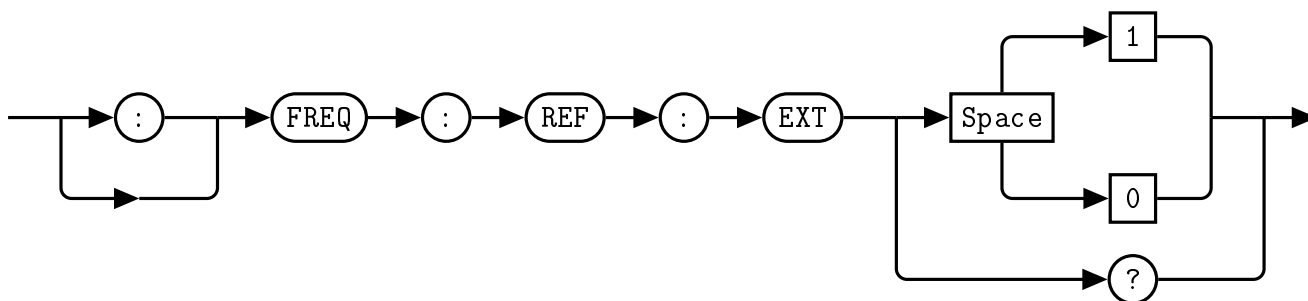

Example

:FREQ:REF:EXT 0 *This command selects the internal reference oscillator.*

Default Condition

On power up, or when a *RST command is issued, the QM1004-8-12-100 returns to the boot state's setting. The Combined RF Upconverter/Downconverter default setting is 0.

Query

:FREQ:REF:EXT? *This query returns a 0 or 1 to indicate the selected Combined RF Upconverter/Downconverter reference mode*

- 0 is returned if the internal reference oscillator is selected
- 1 is returned if the external reference is selected

Error Message

If the parameter is not in the recognized format, error -102, "Syntax error" occurs.

If the parameter is not 1 or 0, error -222, "Data out of range" occurs.

2.9 FREQuency:REFerence:FREQuency <numeric value>

This command allows the user to set the QM1004-8-12-100 reference oscillator frequency in MHz. The allowed values are integers between 10 and 250 MHz.

Syntax

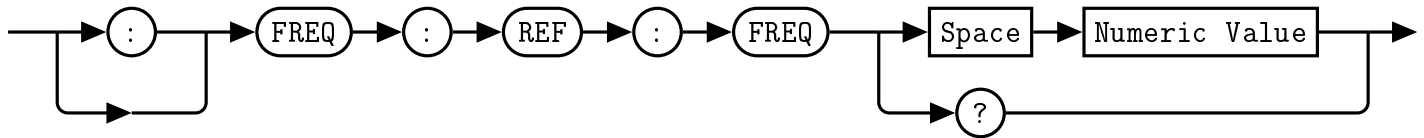

Example

`:FREQ:REF:FREQ 150` This command sets the external reference frequency of the QM1004-8-12-100 to 150 MHz.

Default Condition

On power up, or when a **RST* command is issued, the QM1004-8-12-100 reference frequency returns to the boot state's setting. The Combined RF Upconverter/Downconverter default setting is 10.

Query

`:FREQ:REF:FREQ?` This query returns the center frequency of the QM1004-8-12-100 in MHz.

Error Message

If the parameter is not in the recognized format, error -102, "Syntax error" occurs.

If the parameter is not between 10 and 250, error -222, "Data out of range" occurs.

2.10 FREQuency:REFerence:LOCK

This query allows the user to check the lock status of the external reference signal.

Syntax

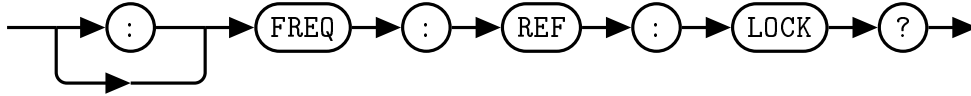

Query

`:FREQ:REF:LOCK?` *This query returns the lock status of the external reference. A lock status of 0 indicates that the reference is unlocked, while a lock status of 1 indicates the reference is locked.*

2.11 FREQuency:TUNE <numeric value>

This command allows the user to set the tuner frequency of the QM1004-8-12-100 for both channels. The frequency value is specified in GHz. The range of acceptable tune frequency values is 8-12 GHz with a 4 decimal place (100 kHz) tuning resolution.

Syntax

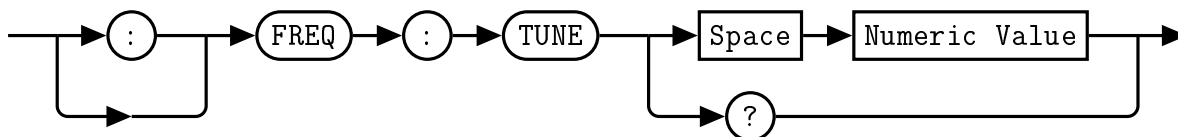

Example

`:FREQ:TUNE 33` *This command sets the center frequency of the QM1004-8-12-100 to 10 GHz.*

Default Condition

On power up, or when a **RST* command is issued, the QM1004-8-12-100 returns to the boot state's setting. The Combined RF Upconverter/Downconverter default setting is 10.

Query

`:FREQ:TUNE?` *This query returns the center frequency of the QM1004-8-12-100 in GHz.*

Error Message

If the parameter is not in the recognized format, error -102, "Syntax error" occurs.
 If the parameter is not between 26 and 40, error -222, "Data out of range" occurs.

2.12 FREQuency:TUNErACTual

This query returns the actual tuner frequency of the QM1004-8-12-100 in GHz for both channels. When in integer mode, this command will return the actual resulting tune frequency as opposed to querying *FREQ:TUNE?*, which will return the last tune frequency that was requested.

Syntax

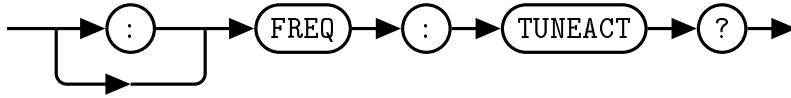

Query

`:FREQ:TUNEACT?` *This query returns the actual tuner frequency of the QM1004-8-12-100 in GHz.*

3. POWER Subsystem Command Reference

3.1 POWER:CH1:ATTENUation <numeric value>

This command allows the user to set the RF attenuation level of the QM1004-8-12-100 upconverter to a specified numeric value. The range of acceptable attenuation values is 0 - 31.5 dB in 0.5 dB steps.

Syntax

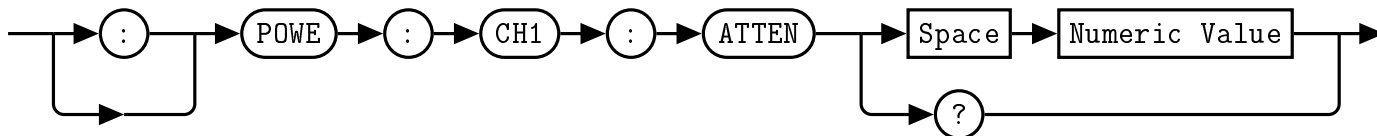

Example

:POWE:CH1:ATTEN 31.5 *This command sets the upconverter attenuation to 31.5 dB*

Default Condition

On power up, or when a *RST command is issued, the QM1004-8-12-100 upconverter attenuation level returns to the boot state's setting. The Combined RF Upconverter/Downconverter default setting is 0.

Query

:POWE:CH1:ATTEN? *This query returns the current upconverter attenuation level.*

Error Message

If the parameter is not in the recognized format, error -102, "Syntax error" occurs.

If the parameter is less than 0 or greater than 31.5, error -222, "Data out of range" occurs.

3.2 POWER:CH2:ATTENUation <numeric value>

This command allows the user to set the RF attenuation level of the QM1004-8-12-100 downconverter to a specified numeric value. The range of acceptable attenuation values is 0 - 31.5 dB in 0.5 dB steps.

Syntax

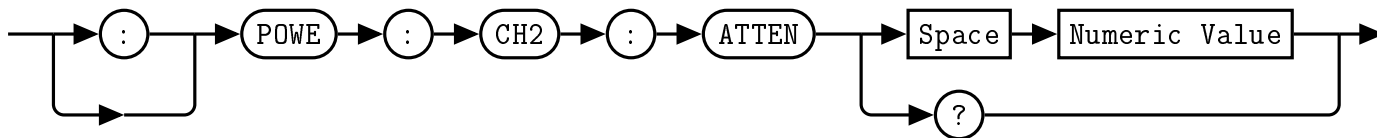

Example

:POWE:CH2:ATTEN 31.5 *This command sets the downconverter attenuation to 31.5 dB*

Default Condition

On power up, or when a **RST* command is issued, the QM1004-8-12-100 downconverter attenuation level returns to the boot state's setting. The Combined RF Upconverter/Downconverter default setting is 0.

Query

:POWE:CH2:ATTEN? *This query returns the current downconverter attenuation level.*

Error Message

If the parameter is not in the recognized format, error -102, "Syntax error" occurs.

If the parameter is less than 0 or greater than 31.5, error -222, "Data out of range" occurs.

3.3 POWER:LNA [ON|OFF|1|0]

This command allows the user to turn on and off the Upconverter LNA gain stage of the QM1004-8-12-100.

When *0* or *OFF* is specified, the LNA is turned off.

When *1* or *ON* is specified, the LNA is turned on.

Syntax

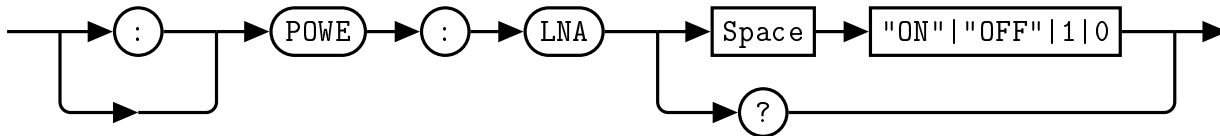

Example

`:POWE:LNA 0` *This command turns off the LNA.*

Default Condition

On power up, or when a **RST* command is issued, the QM1004-8-12-100 returns to the boot state's setting. The Combined RF Upconverter/Downconverter default setting is 0.

Query

`:POWE:LNA?` *This query returns a 0 or 1 to indicated the Combined RF Upconverter/Downconverter power state.*

- 0 is returned if the LNA is *OFF*
- 1 is returned if the LNA is *ON*

Error Message

If the parameter is not in the recognized format, error *-102*, "Syntax error" occurs.

3.4 POWER:RF [ON|OFF|1|0]

This command allows the user to turn on and off the RF power of the QM1004-8-12-100.

When *0* or *OFF* is specified, the RF power is turned off.

When *1* or *ON* is specified, the RF power is turned on.

Syntax

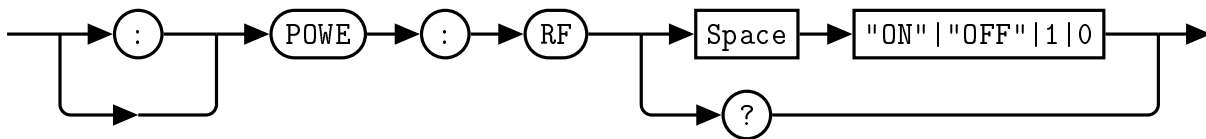

Example

:POWE:RF 0 *This command turns off the RF power.*

Default Condition

On power up, or when a **RST* command is issued, the QM1004-8-12-100 returns to the boot state's setting. The Combined RF Upconverter/Downconverter default setting is 0.

Query

:POWE:RF? *This query returns a 0 or 1 to indicated the Combined RF Upconverter/Downconverter power state.*

- 0 is returned if the RF power is *OFF*
- 1 is returned if the RF power is *ON*

Error Message

If the parameter is not in the recognized format, error -102, "Syntax error" occurs.

4. STATus Subsystem Command Reference

4.1 STATus:OPERation?

This query returns the contents of the status event register. Reading from this event register clears it.

The use of the :EVENT token is optional.

Syntax

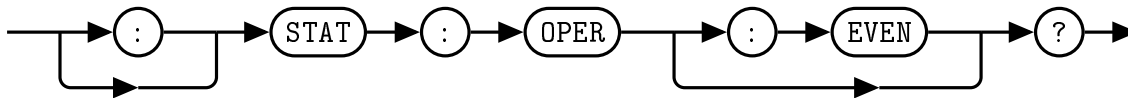

Allowed Values

The *NRf* parameter can be any integer in the range of 0 to 32767.

Query

:STAT:OPER? *The status event register is queried.*

Reset Condition

On reset, the status event register is cleared.

4.2 STATus:OPERation:CONDition?

This query returns the contents of the condition register.

Syntax

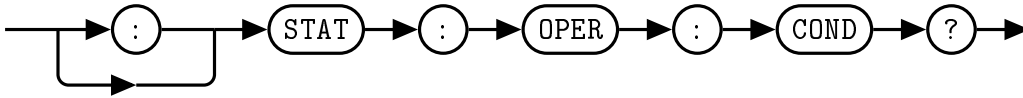

Allowed Values

The *NRf* parameter can be any integer in the range of 0 to 32767.

Query

:STAT:OPER:COND? *The condition register is queried.*

Reset Condition

On reset, the condition register is cleared.

4.3 STATus:OPERation:ENABle <NRf>

This command sets the enable mask for the status event register. A bit value of 1 in the mask will allow a positive transition in the associated summary bit of the event register if the event bit transitions to true.

Syntax

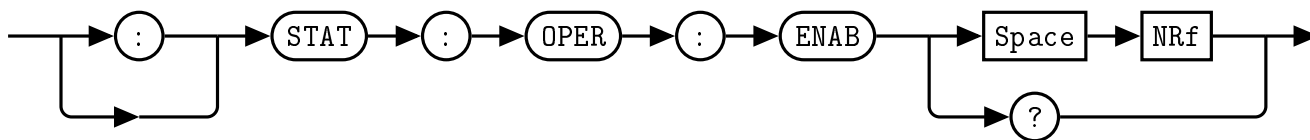

Allowed Values

The *NRf* parameter can be any integer in the range of 0 to 32767.

Query

:STAT:OPER:ENAB? *The event register enable bit mask is queried.*

Reset Condition

On reset, the enable bit mask register is cleared.

Error Message

If the parameter is not in the recognized format, error -102, "Syntax error" occurs.

If the parameter is less than 0 or greater than 32767, error -222, "Data out of range" occurs.

4.4 STATus:PRESet

The PRESet command presets the STATus:QUESTionable:ENABLE register to 0. No other registers are affected. *CLS;*SRE 0;*ESE 0 is the recommended command sequence to reset all other status/event registers.

Syntax

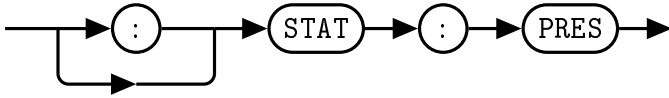

Example

:STAT:PRESet *The questionable enable register is preset.*

4.5 STATus:QUEStionable?

This query returns the contents of the questionable status register. A value of 1 in the bit indicates the accuracy of the signal is of questionable quality.

The use of the :EVENT token is optional.

Syntax

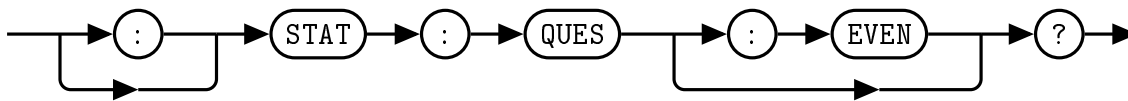

Allowed Values

The *NRf* parameter can be any integer in the range of 0 to 32767.

Query

:STAT:QUES? *The questionable register is queried.*

Reset Condition

On reset, the questionable register is cleared.

4.6 STATus:QUEStionable:CONDition?

This query returns the contents of the questionable condition register.

Syntax

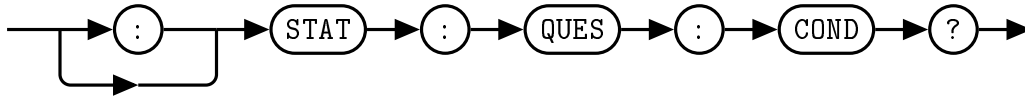

Allowed Values

The *NRf* parameter can be any integer in the range of 0 to 32767.

Query

:STAT:QUES:COND? *The questionable condition register is queried.*

Reset Condition

On reset, the questionable condition register is cleared.

4.7 STATus:QUESTionable:ENABle <NRf>

This command sets the enable mask for the questionable event register. A bit value of 1 in the mask will allow a positive transition in the associated summary bit of the questionable event register if the event bit transitions to true.

Syntax

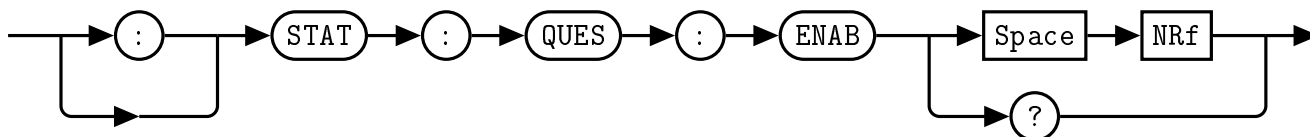

Allowed Values

The *NRf* parameter can be any integer in the range of 0 to 32767.

Query

:STAT:QUES:ENAB? *The questionable register enable bit mask is queried.*

Reset Condition

On reset, the enable bit mask register is cleared.

Error Message

If the parameter is not in the recognized format, error -102, "Syntax error" occurs.

If the parameter is less than 0 or greater than 32767, error -222, "Data out of range" occurs.

5. SYSTem Subsystem Command Reference

5.1 SYSTem:BOOTstate [0-5]

This command specifies a previously saved state to be loaded upon device startup. In addition to factory default state 0, there are 5 re-writeable memory locations. Any of these 6 boot states can be selected by choosing an index between 0 and 5. The restored parameters are the *RF Power State*, *Upconverter LNA Power State*, *Reference Frequency*, *External Reference Enable*, *External Reference Switch Override*, *Tune Frequency*, *External LO1 Enable*, *External LO1 Switch Override*, *LO1 PLL Mode*, *LO1 Reference Divider*, *External LO2 Enable*, *External LO2 Switch Override*, *Upconverter RF Attenuation*, *Downconverter RF Attenuation*. For a detailed description of the parameters saved, see the relevant command descriptions in this manual. When this command is issued, the selected state will be loaded on the next power cycle or by issuing the **RST* command.

Syntax

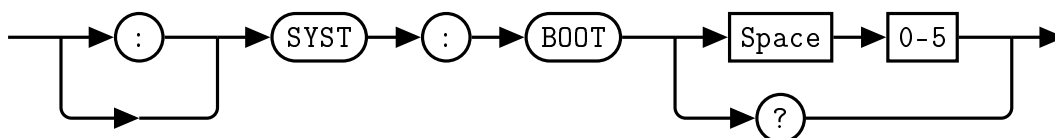

There are 6 memory locations, numbered 0 through 5. Memory location 0 contains the factory default settings, while locations 1-5 are user re-writeable using SYSTem:SAVEstate.

Example

:SYST:BOOT 1 *This command specifies state 1 to be loaded upon device powerup.*

Default Condition

The factory default setting for SYST:BOOT is 0.

Query

:SYST:BOOT? *This query returns a 0 - 5 to indicate the Combined RF Upconverter/Downconverter selected boot state.*

- 0 is returned if the selected boot state is 0

Error Message

If the parameter is not in the recognized format, error -102, "Syntax error" occurs.

If the parameter is less than 0 or greater than 5, error -222, "Data out of range" occurs.

5.2 SYSTem:CURRent?

This command returns the current reading from the Combined RF Upconverter/Downconverter in Amps.

Syntax

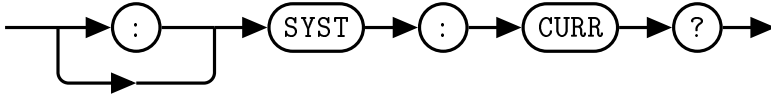

Query Example

:SYST:CURR? *This query returns the QM1004-8-12-100 current draw in Amps.*

5.3 SYSTem:ERRor[:NEXT]?

This query returns error numbers and messages from the QM1004-8-12-100 error queue. When an error is generated by the QM1004-8-12-100, the error number and corresponding error message are stored in the error queue. Each time the error queue is queried, the first error in the error queue is returned. The errors are read out in the order of first-in first-out. To clear all errors in the error queue, use the *CLS command.

When the error queue is empty, a query of the error queue will return a 0, "No error" message. The error queue has a maximum capacity of 10 errors.

The use of the :NEXT token is optional.

Syntax

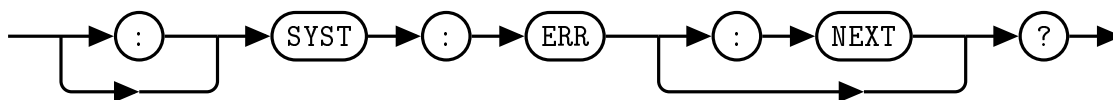

Query Example

:SYST:ERR? *Queries the system error.*

Error queue messages have the following format:



For example, -102, "Syntax error"

Reset Condition

On reset, the error queue is cleared.

Error Message List

Table 4.7: Error Codes and Messages

-101	Invalid character Invalid character was found in the command string.
-102	Syntax error Invalid syntax was found in the command string.
-103	Invalid separator Invalid separator was found in the command string.
-105	GET not allowed A Group Execute Trigger (GET) is not allowed within a command string.
-108	Parameter not allowed More parameters were received than expected for the command.

-109	Missing parameter Fewer parameters were received than expected for the command.
-112	Program mnemonic too long A command header was received which contained more than the maximum 12 characters allowed.
-113	Undefined header A command was received that is not valid for the Combined RF Upconverter/-Downconverter.
-121	Invalid character in number An invalid character was found in the number specified for a parameter value.
-123	Exponent too large A numeric parameter was found whose exponent was larger than 32,000.
-124	Too many digits A numeric parameter was found whose mantissa contained more than 255 digits.
-128	Numeric data not allowed A numeric value was received within a command which does not accept a numeric value.
-131	Invalid suffix A unit was incorrectly specified for a numeric parameter.
-134	Suffix too long A unit used contained more than 12 characters.
-138	Suffix not allowed A unit was received following a numeric parameter which does not accept a unit.
-141	Invalid character data An invalid character was received.
-148	Character data not allowed A discrete parameter was received but a character string or numeric parameter was expected.
-151	Invalid string data An invalid string was received.
-158	String data not allowed A character string was received but not allowed for the command.
-161	Invalid block data A block data element was expected but was invalid.
-168	Block data not allowed A legal block data element was encountered but not allowed by the Product.

-178	<p>Expression data not allowed</p> <p>A legal expression data element was encountered but not allowed by the Product.</p>
-200	<p>Execution error</p> <p>Indicates that an execution error has occurred.</p>
-211	<p>Trigger ignored</p> <p>Indicates that a trigger command was received but ignored because the Combined RF Upconverter/Downconverter was not in the wait for trigger state.</p>
-213	<p>Trigger ignored</p> <p>Indicates that a trigger command was received but ignored because the Combined RF Upconverter/Downconverter was not in the wait for trigger state.</p>
-222	<p>Data out of range</p> <p>A numeric parameter value is outside the valid range for the command.</p>
-224	<p>Illegal parameter value</p> <p>A discrete parameter was received which was not a valid choice for the command.</p>
-230	<p>Data corrupt or stale</p> <p>This occurs when a measurement command is attempted and either a reset has been received or the state of the Combined RF Upconverter/Downconverter has changed such that the measurement is no longer valid.</p>
-241	<p>Hardware missing</p> <p>The Combined RF Upconverter/Downconverter is unable to execute the command because the hardware does not support that feature.</p>
-310	<p>System error</p> <p>This error indicates a failure with the Combined RF Upconverter/Downconverter.</p>
-330	<p>Self-test failed</p> <p>The -330, "Self-test failed" error indicates a problem with the Combined RF Upconverter/Downconverter.</p>
-350	<p>Queue overflow</p> <p>The error queue is full and another error has occurred which could not be recorded.</p>
-410	<p>Query INTERRUPTED</p> <p>A command was received which sends data to the output buffer, but the output buffer contained data from a previous command. The output buffer is cleared when power has been off or after a *RST command has been issued.</p>
-420	<p>Query UNTERMINATED</p> <p>The Combined RF Upconverter/Downconverter was addressed to talk but a command has not been received which sends data to the output buffer.</p>

-430	Query DEADLOCKED A command was received which generates too much data to fit in the output buffer and the input buffer is also full. Command execution continues but data is lost.
-440	Query UNTERMINATED after indefinite response The *IDN? command must be the last query command within a command string.
+0	No error No errors in the error queue. Device is operating normally.
+110	Invalid Command For Specified Device The issued command is invalid for the specified device.

5.4 SYSTem:FIRMware?

This query returns the current PIC firmware version of the Combined RF Upconverter/Downconverter.

Syntax

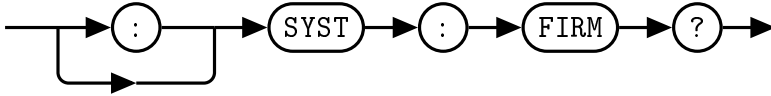

Query Example

:SYST:FIRM? *This query returns the current firmware version of the Combined RF Upconverter/Downconverter.*

5.5 SYSTem:LOADstate [0-5]

This command restores a previously saved state from non-volatile memory. In addition to factory default state 0, there are 5 re-writeable memory locations, specified by choosing an index between 1 and 5. The restored parameters are the *RF Power State*, *Upconverter LNA Power State*, *Reference Frequency*, *External Reference Enable*, *External Reference Switch Override*, *Tune Frequency*, *External LO1 Enable*, *External LO1 Switch Override*, *LO1 PLL Mode*, *LO1 Reference Divider*, *External LO2 Enable*, *External LO2 Switch Override*, *Upconverter RF Attenuation*, *Downconverter RF Attenuation*. For a detailed description of the parameters saved, see the relevant command descriptions in this manual. When the SYSTem:LOADstate command is called, these parameters will be applied to the device.

Syntax

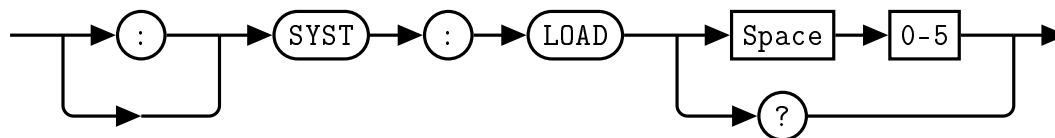

There are 6 memory locations, numbered 0 through 5. Memory location 0 contains the factory default settings, while locations 1-5 are user re-writeable using SYSTem:SAVEstate.

Example

:SYST:LOAD 4 *This command loads the state 4 parameters from non-volatile memory and applies them to the device.*

Error Message

If the parameter is not in the recognized format, error -102, "Syntax error" occurs.

If the parameter is less than 0 or greater than 5, error -222, "Data out of range" occurs.

5.6 SYSTem:READstate? [0-5]

This query allows the user to read the parameters of the stored states without changing any internal registers. The query output is a list of parameters for the selected state. If no state parameter is given, the returned state is state 0. The list of state parameters contains comma separated values, without spaces, in the following order: *RF Power State, Upconverter LNA Power State, Reference Frequency, External Reference Enable, External Reference Switch Override, Tune Frequency, External LO1 Enable, External LO1 Switch Override, LO1 PLL Mode, LO1 Reference Divider, External LO2 Enable, External LO2 Switch Override, Upconverter RF Attenuation, Downconverter RF Attenuation*. See the respective command definitions for descriptions of each parameter.

Syntax

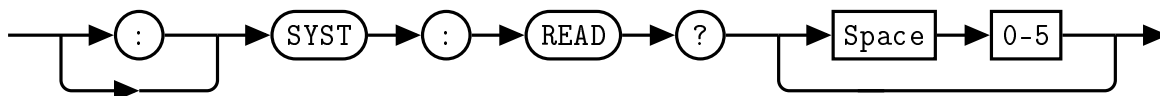

Query

`:SYST:READ? 0` This query requests the parameter values of state 0.

Response: `0,0,100,0,0,10.0000,0,0,1,1,0,0,0.0,0.0`

- 0 = POWER:RF is set to 0 or OFF. (page 41)
- 0 = POWER:LNA is set to 0 or OFF. (page 40)
- 100 = FREQUENCY:REFERENCE:FREQUENCY is set to 100 MHz. (page 34)
- 0 = FREQUENCY:REFERENCE:EXTERNAL is set to 0 or Internal. (page 33)
- 0 = External Reference Switch Override is 0 (switch-controlled).
- 10.0000 = FREQUENCY:TUNE is set to 10 GHz. (page 36)
- 0 = FREQUENCY:LO1:EXTERNAL is set to 0 or Internal. (page 26)
- 0 = External LO1 Switch Override is 0 (switch-controlled).
- 1 = FREQUENCY:LO1:PLLMODE is set to 1 or Integer. (page 28)
- 1 = FREQUENCY:LO1:DIVIDER is set to 1. (page 25)
- 0 = FREQUENCY:LO2:EXTERNAL is set to 0 or Internal. (page 30)
- 0 = External LO2 Switch Override is 0 (switch-controlled).
- 0.0 = POWER:CH1:ATTENUATION is set to 0 dB. (page 38)
- 0.0 = POWER:CH2:ATTENUATION is set to 0 dB. (page 39)

Error Message

If the parameter is not in the recognized format, error -102, "Syntax error" occurs.

If the parameter is less than 0 or greater than 5, error -222, "Data out of range" occurs.

5.7 SYSTem:SAVEstate [1-5]

This command saves the current setup to non-volatile memory. There are 5 re-writeable memory locations, specified by choosing an index between 1 and 5. Any of the 5 states can be restored on startup when specified with the SYSTem:BOOTstate command. The parameters saved are the *RF Power State*, *Upconverter LNA Power State*, *Reference Frequency*, *External Reference Enable*, *External Reference Switch Override*, *Tune Frequency*, *External LO1 Enable*, *External LO1 Switch Override*, *LO1 PLL Mode*, *LO1 Reference Divider*, *External LO2 Enable*, *External LO2 Switch Override*, *Upconverter RF Attenuation*, *Downconverter RF Attenuation*. For a detailed description of the parameters saved, see the relevant command descriptions in this manual. NOTE: The MEM_CLR button on the back panel will rewrite the contents of states 1-5 with the contents of state 0 when depressed, serving as a reset to factory defaults.

Syntax

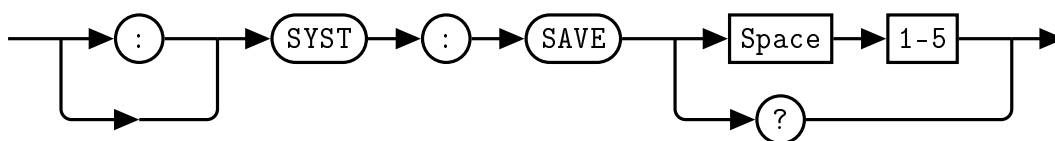

There are 5 memory locations, numbered 1 through 5. Memory location 0 contains the factory default settings and is write-protected.

Example

`:SYST:SAVE 3` *This command saves the current state to memory location 3*

Error Message

If the parameter is not in the recognized format, error -102, "Syntax error" occurs.

If the parameter is less than 1 or greater than 5, error -222, "Data out of range" occurs.

5.8 SYSTem:SERialNUMBER?

This query returns the serial number of the device.

Syntax

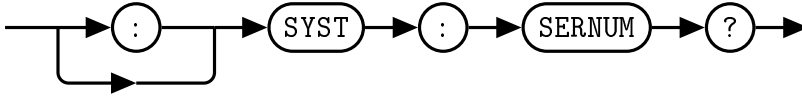

Query Example

:SYST:SERNUM? *This query returns the serial number of the device.*

5.9 SYSTem:USBPID?

This query returns the USB Product ID of the Combined RF Upconverter/Downconverter. The response is "0x0022" for the QM1004-8-12-100.

Syntax

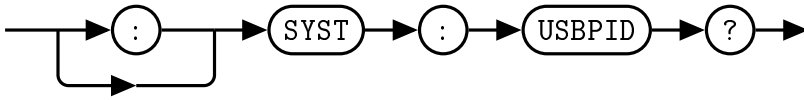

Query Example

:SYST:USBPID? *This query returns the USBPID of the Combined RF Upconverter/Downconverter.*

5.10 SYSTem:VERSion?

This query returns the version of SCPI used in the Combined RF Upconverter/Downconverter. The response is in the format XXXX.Y, where XXXX is the year and Y is the version number.

Syntax

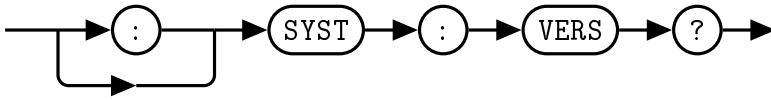

Query Example

:SYST:VERS? *This query returns the version of SCPI used in the Combined RF Upconverter/Downconverter.*

6. IEEE 488.2 Command Reference

6.1 Introduction

This chapter contains information on the IEEE-488.2 Common Commands that the Combined RF Upconverter/Downconverter supports.

The IEEE-488.2 Common Command descriptions are listed below.

Table 4.8: IEEE 488.2 Common commands

<i>*CLS</i>	Clear Status	Page 63
<i>*ESE</i> and <i>*ESE?</i>	Event Status Enable	Page 64
<i>*ESR?</i>	Event Status Register	Page 65
<i>*IDN?</i>	Identify	Page 66
<i>*OPC</i> and <i>*OPC?</i>	Operation Complete	Page 67
<i>*RCL</i>	Recall	Page 68
<i>*RST</i>	Reset	Page 69
<i>*SAV</i>	Save	Page 70
<i>*SDS</i>	Save Default Settings	Page 71
<i>*SRE</i> and <i>*SRE?</i>	Service Request Enable	Page 72
<i>*STB?</i>	Status Byte	Page 73
<i>*TST?</i>	Test	Page 74
<i>*WAI</i>	Wait	Page 75

6.2 *CLS

The *CLS (CLear Status) command clears the data structures. The SCPI registers are all cleared.

Syntax

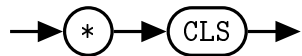

6.3 *ESE <NRf>

The *ESE (Event Status Enable) command sets the Standard Event Status Enable Register. This register contains a mask value for the bits to be enabled in the Standard Event Status Register. A 1 in the enable register enables the corresponding bit in the Status Register, a 0 disables the corresponding bit in the Status Register. The parameter value when expressed in base 2, represents the bit values of the Standard Event Status Enable Register. Table 4.9 shows the contents of this register.

Table 4.9: *ESE bit mapping

Bit	Base 2	Meaning
0	1	Operation Complete
1	2	Request Control (not used)
2	4	Query Error
3	8	Device Dependent Error
4	16	Execution Error
5	32	Command Error
6	64	Not Used
7	128	Power On

Syntax

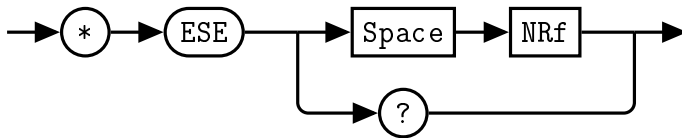

Allowed Values

The NRf parameter can be any integer in the range of 0 to 255.

Query

*ESE? This query returns the contents of the Standard Event Status Enable Register.

Error Message

If the parameter is not in the recognized format, error -102, "Syntax error" occurs.

If the parameter is less than 0 or greater than 255, error -222, "Data out of range" occurs.

6.4 *ESR?

The **ESR?* query returns the contents of the Standard Event Status Register then clears it. The returned value is in the range of 0 to 255. Table 4.10 shows the contents of this register.

Table 4.10: *ESR? mapping

Bit	Base 2	Meaning
0	1	Operation Complete
1	2	Not Used
2	4	Query Error
3	8	Device Dependent Error
4	16	Execution Error
5	32	Command Error
6	64	Not Used
7	128	Power On

Syntax



6.5 *IDN?

The **IDN?* query allows the connected device to identify itself. The string returned is:

Quonset Microwave,<Product Number>,<Serial Number>,<Firmware>

where:

- *<Product Number>* identifies the product number of the host
- *<Serial Number>* uniquely identifies the host
- *<Firmware>* returns the firmware of the host

Syntax



6.6 *OPC

The *OPC (Operation Complete) command causes the QM1004-8-12-100 Combined RF Upconverter/Downconverter to set the operation complete bit in the Standard Event Status Register when all pending device operations have been completed.

Table 4.11: *OPC mapping

Bit	Base 2	Meaning
0	1	Operation Complete
1	2	Not Used
2	4	Query Error
3	8	Device Dependent Error
4	16	Execution Error
5	32	Command Error
6	64	Not Used
7	128	Power On

Syntax

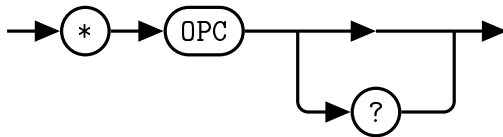

Query

*OPC? *This query places a 1 in the output queue when all device operations have been completed.*

6.7 *RCL <NRf>

The **RCL* (ReCaLI) command restores a previously saved state from non-volatile memory. In addition to factory default state 0, there are 5 re-writeable memory locations, specified by choosing an index between 1 and 5. The restored parameters are the *RF Power State*, *Upconverter LNA Power State*, *Reference Frequency*, *External Reference Enable*, *External Reference Switch Override*, *Tune Frequency*, *External LO1 Enable*, *External LO1 Switch Override*, *LO1 PLL Mode*, *LO1 Reference Divider*, *External LO2 Enable*, *External LO2 Switch Override*, *Upconverter RF Attenuation*, *Downconverter RF Attenuation*. For a detailed description of the parameters saved, see the relevant command descriptions in this manual. When the **RCL* command is called, these parameters will be applied to the device.

Syntax

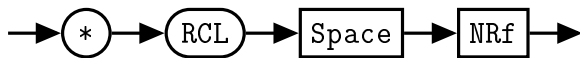

Allowed Values

The *NRf* parameter can be any integer in the range of 0 to 5.

Error Message

If the parameter is not in the recognized format, error -102, "*Syntax error*" occurs.

If the parameter is less than 0 or greater than 5, error -222, "*Data out of range*" occurs.

6.8 *RST

The **RST* (ReSeT) command returns the QM1004-8-12-100 Combined RF Upconverter/Downconverter to its initial power-up state.

Syntax



6.9 *SAV <NRf>

The *SAV (SAVe) command saves the current setup to non-volatile memory. There are 5 re-writeable memory locations, specified by choosing an index between 1 and 5. Any of the 5 states can be restored on startup when specified with the SYSTem:BOOTstate command. The parameters saved are the *RF Power State, Upconverter LNA Power State, Reference Frequency, External Reference Enable, External Reference Switch Override, Tune Frequency, External LO1 Enable, External LO1 Switch Override, LO1 PLL Mode, LO1 Reference Divider, External LO2 Enable, External LO2 Switch Override, Upconverter RF Attenuation, Downconverter RF Attenuation*. For a detailed description of the parameters saved, see the relevant command descriptions in this manual. NOTE: The MEM_CLR button on the back panel will rewrite the contents of states 1-5 with the contents of state 0 when depressed, serving as a reset to factory defaults.

Syntax

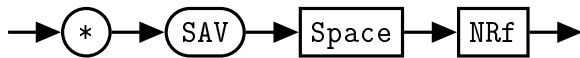

Allowed Values

The *NRf* parameter can be any integer in the range of 1 to 5.

Error Message

If the parameter is not in the recognized format, error -102, "Syntax error" occurs.

If the parameter is less than 1 or greater than 5, error -222, "Data out of range" occurs.

6.10 *SDS <NRf>

The *SDS (Save Default device Settings) command restores the specified state of the QM1004-8-12-100 Combined RF Upconverter/Downconverter to the default state settings. There are 5 re-writeable memory locations, specified by choosing an index between 1 and 5. The parameters restored are the *RF Power State, Upconverter LNA Power State, Reference Frequency, External Reference Enable, External Reference Switch Override, Tune Frequency, External LO1 Enable, External LO1 Switch Override, LO1 PLL Mode, LO1 Reference Divider, External LO2 Enable, External LO2 Switch Override, Upconverter RF Attenuation, Downconverter RF Attenuation*. For a detailed description of the parameters saved, see the relevant command descriptions in this manual. Issuing this command does not change the current settings. NOTE: The MEM_CLR button on the back panel will rewrite the contents of states 1-5 with the contents of state 0 when depressed, serving as a reset to factory defaults.

Syntax

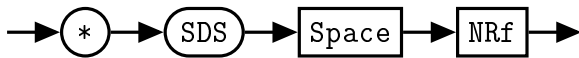

Allowed Values

The *NRf* parameter can be any integer in the range of 1 to 5.

Error Message

If the parameter is not in the recognized format, error -102, "Syntax error" occurs.

If the parameter is less than 1 or greater than 5, error -222, "Data out of range" occurs.

6.11 *SRE <NRf>

The *SRE command sets the Service Request Enable register bits. This register contains a mask value for the bits to be enabled in the Status Byte Register. A 1 in the enable register enables the corresponding bit in the Status Register, a 0 disables the corresponding bit in the Status Register. The parameter value when expressed in base 2, represents bits 0 to 5 and bit 7 of the Service Request Enable Register. Bit 6 is not used and is always 0. Table 4.12 shows the contents of this register.

Table 4.12: *SRE bit mapping

Bit	Base 2	Meaning
0	1	Not used
1	2	Not Used (not used)
2	4	Device Dependent
3	8	Questionable Status Summary
4	16	Message Available
5	32	Event Status Bit
6	64	Not Used
7	128	Operation Status Summary

Syntax

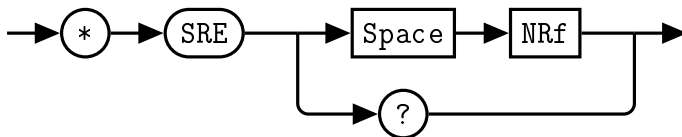

Allowed Values

The NRf parameter can be any integer in the range of 0 to 255.

Query

*SRE? *This query returns the contents of bits 0 to 5 and bit 7 of the Service Request Enable Register. Bit 6 is always 0.*

Error Message

If the parameter is not in the recognized format, error -102, "Syntax error" occurs.
 If the parameter is less than 0 or greater than 255, error -222, "Data out of range" occurs.

6.12 *STB?

The **STB?* (S**T**atus **B**yte) query returns bit 0 to 5 and bit 7 of the QM1004-8-12-100 Combined RF Up-converter/Downconverter status byte and returns the Master Summary Status (MSS) as bit 6. The MSS is inclusive OR of the bitwise combination (excluding bit 6) of the Status Byte and the Service Request Enable registers. The format of the return is an integer between 0 and 255. Table 4.13 shows the contents of this register.

Table 4.13: *STB? mapping

Bit	Base 2	Meaning
0	1	Not used
1	2	Device Dependent 0 - No device status condition has occurred 1 - A device status condition has occurred
2	4	Error/Event Queue 0 = Queue empty 1 = Queue not empty
3	8	Questionable Status Summary 0 - No QUEStionable status conditions have occurred 1 - A QUEStionable status condition has occurred
4	16	Message Available 0 - no output messages are ready 1 - an output message is ready
5	32	Event Status Bit 0 - no event status has occurred 1 - an event status condition has occurred
6	64	Master Summary Status 0 - Combined RF Upconverter/Downconverter not re-questing service 1 - there is at least one reason for requesting service
7	128	Operation Status Summary 0 = No OPERation status conditions have occurred 1 = An OPERation status condition has occurred

Syntax



6.13 *TST?

The **TST?* query causes the QM1004-8-12-100 Combined RF Upconverter/Downconverter to perform a self-test. The result of the self-test is placed in the output queue.

- 0 is returned if the test passes

Syntax



6.14 *WAI

The **WAI* (WAI) command causes the QM1004-8-12-100 Combined RF Upconverter/Downconverter to wait until either:

- All pending operations are complete
- The *Device Clear* command is received
- Power is cycled

before executing any subsequent commands or queries.

Syntax

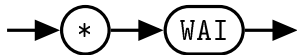



5 Windows Control GUI

In This Chapter

1. Overview	77
-----------------------	----

1. Overview

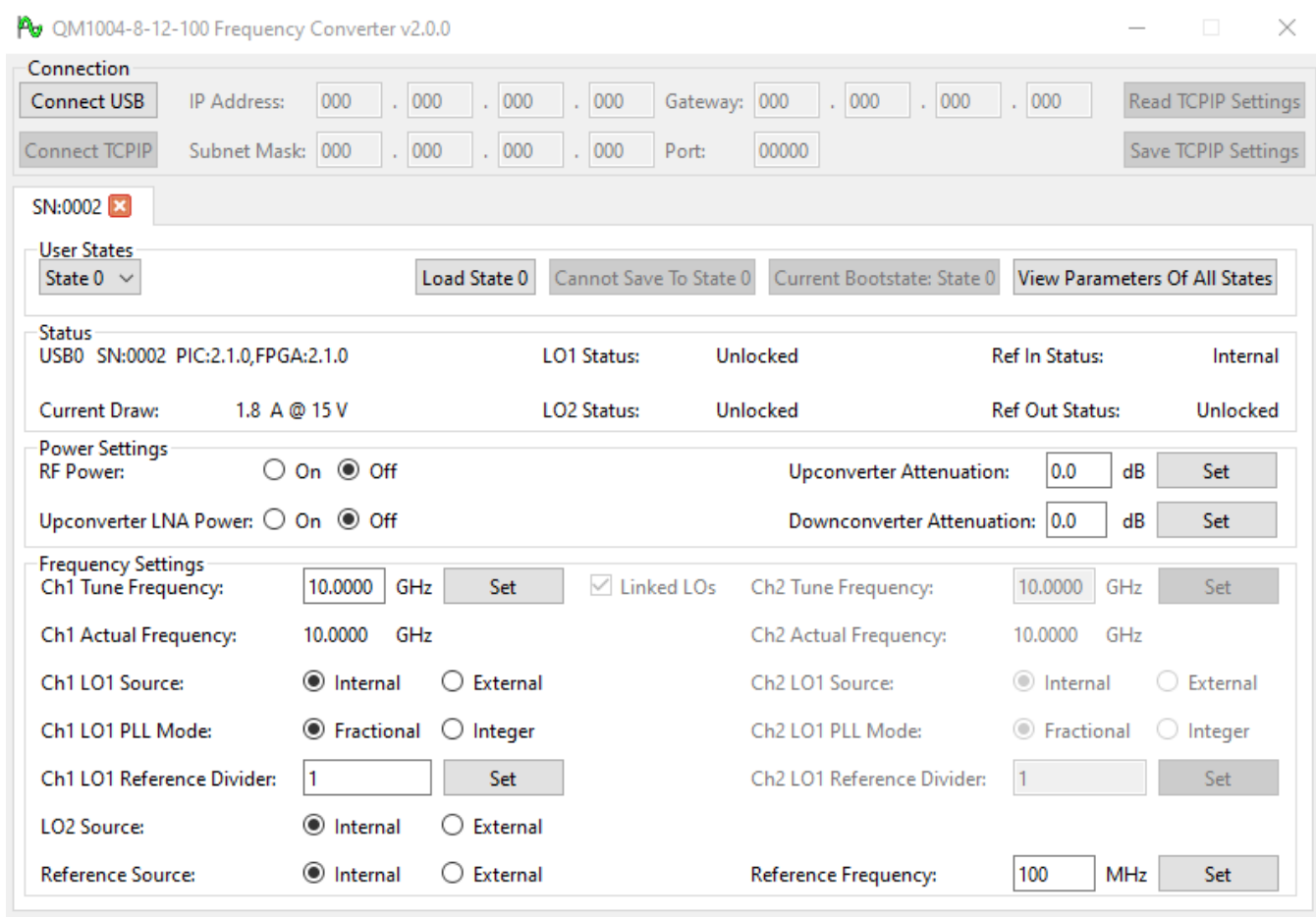

Figure 5.1: Windows® Control GUI

The Graphical User Interface (GUI) for the QM1004-8-12-100 is shown above in Figure 5.1. This GUI provides the current status and provides all of the essential functionality for the Combined RF Upconverter/Downconverter system. The GUI allows the user to toggle RF power, LNA power, and to set user states, attenuation control, tune the device, and change reference settings.

Index

Control Commands, 20

- FREQUency:LO1:DIVider, 25
- FREQUency:LO1:EXTernal, 26
- FREQUency:LO1:LOCK, 27
- FREQUency:LO1:PLLMode, 28
- FREQUency:LO2:EXTernal, 30
- FREQUency:LO2:LOCK, 31
- FREQUency:LOCK, 32
- FREQUency:REFerence:EXTernal, 33
- FREQUency:REFerence:FREQUency, 34
- FREQUency:REFerence:LOCK, 35
- FREQUency:TUNE, 36
- FREQUency:TUNErACTual, 37
- POWER:CH1:ATTENUation, 38
- POWER:CH2:ATTENUation, 39
- POWER:LNA, 40
- POWER:RF, 41
- STATus:OPERation, 42
- STATus:OPERation:CONDition, 43
- STATus:OPERation:ENABLE, 44
- STATus:OPERation:QUESTionable, 47
- STATus:PRESet, 45
- STATus:QUESTionable, 46
- STATus:QUESTionable:ENABLE, 48
- SYSTem:BOOTSTATE, 49
- SYSTem:CURRent, 50
- SYSTem:ERRor, 51
- SYSTem:FIRMware, 55
- SYSTem:LOADstate, 56
- SYSTem:READstate, 57
- SYSTem:SAVE, 58
- SYSTem:SERialNUMber, 59
- SYSTem:USBPID, 60
- SYSTem:VERSion, 61

Default Units, 14

Firmware Updates, 8

- FTP Location, 9
- Introduction, 9

PIC Firmware Updates, 10

FREQUency Subsystem Command Reference

- FREQUency:LO1:DIVider, 25
- FREQUency:LO1:EXTernal, 26
- FREQUency:LO1:LOCK, 27
- FREQUency:LO1:PLLMode, 28
- FREQUency:LO2:EXTernal, 30
- FREQUency:LO2:LOCK, 31
- FREQUency:LOCK, 32
- FREQUency:REFerence:EXTernal, 33
- FREQUency:REFerence:FREQUency, 34
- FREQUency:REFerence:LOCK, 35
- FREQUency:TUNE, 36
- FREQUency:TUNErACTual, 37

General Description, 5

General Safety Information, iii

IEEE 488.2 Command Reference, 62

- *CLS, 63
- *ESE, 64
- *ESR?, 65
- *IDN?, 66
- *OPC, 67
- *RCL, 68
- *RST, 69
- *SAV, 70
- *SDS, 71
- *SRE, 72
- *STB?, 73
- *TST?, 74
- *WAI, 75

Input/Output Specifications, 3

Notices, i

Overview, 2

POWER Subsystem Command Reference

- POWER:CH1:ATTENUation, 38
- POWER:CH2:ATTENUation, 39

- POWER:LNA, 40
- POWER:RF, 41
- Product Safety, ii
- Remote Operation, 11
 - Introduction, 13
 - Command Syntax, 13
 - Compliance Information, 17
 - Default Units, 14
 - Diagram Syntax Conventions, 13
 - Input Message Terminators, 17
 - SCPI Data Types, 14
 - Status Reporting, 14
 - USB, 13
 - VISA Descriptors and Configuration, 19
 - USB, 19
- STATUS Subsystem Command Reference
 - STATUS:OPERation, 42
 - STATUS:OPERation:CONDition, 43
 - STATUS:OPERation:ENABle, 44
 - STATUS:OPERation:QUESTionable, 47
 - STATUS:PRESet, 45
 - STATUS:QUESTionable, 46
 - STATUS:QUESTionable:ENABle, 48
- System Block Diagram, 6
- SYSTEM Subsystem Command Reference
 - SYSTEM:BOOTSTATE, 49
 - SYSTEM:CURREnt, 50
 - SYSTEM:ERRor, 51
 - SYSTEM:FIRMware, 55
 - SYSTEM:LOADstate, 56
 - SYSTEM:READstate, 57
 - SYSTEM:SAVE, 58
 - SYSTEM:SERialNUMBER, 59
 - SYSTEM:USBPID, 60
 - SYSTEM:VERSion, 61
- Windows Control GUI, 76
 - Overview, 77



Quonset Microwave
www.quonsetmicrowave.com



1004-009-21

Revision 2.0.0, June 2021