



**Quonset Microwave**

www.quonsetmicrowave.com

---

**QM1007-9765-1200**  
**Single-Channel, Single-Stage**  
**Up/Downconverter**

**User Manual**

Revision 0.1.0, April 2019

---

## Notices

© 2019 Quonset Microwave

No part of this manual may be reproduced in any form or by any means (including electronic storage and retrieval or translation into a foreign language) without prior permission and written consent from Quonset Microwave as governed by United States and international copyright laws.

### Manual Part Number

1007-014-21

### Edition

Revision 0.1.0, April 2019

Printed in the USA

Quonset Microwave

315 Commerce Park Road

Unit 3

North Kingstown, RI 02852 USA

### Warranty

The material contained in this document is provided "as is," and is subject to be changed, without notice, in future editions. Further, to the maximum extent permitted by applicable law, Quonset Microwave disclaims all warranties, either expressed or implied, with regard to this manual and any information contained herein, including but not limited to the implied warranties of merchantability and fitness for a particular purpose. Quonset Microwave shall not be liable for errors or incidental or consequential damages in connection with the furnishing, use, or performance of this document or of any information contained herein. Should Quonset Microwave and the user have a separate written agreement with warranty terms covering the material in this document that conflict with these terms, the warranty terms in the separate agreement shall control.

### Technology Licenses

The hardware and/or software described in this document are furnished under a license and may be used or copied only in accordance with the terms of such license.

### Restricted Rights Legend

U.S. Government Restricted Rights. Software and technical data rights granted to the federal government include only those rights customarily provided to end user customers.

Quonset Microwave provides this customary commercial license in Software and technical data pursuant to FAR 12.211 (Technical Data) and 12.212 (Computer Software) and, for the Department of Defense, DFARS 252.227-7015 (Technical Data - Commercial Items) and DFARS 227.7202-3 (Rights in Commercial Computer Software or Computer Software Documentation).

### Safety Notices

---

#### CAUTION

A **CAUTION** notice denotes a hazard. It calls attention to an operating procedure, practice, or the like that, if not correctly performed or adhered to, could result in damage to the product or loss of data. Do not proceed beyond a **CAUTION** notice until the indicated conditions are fully understood and met.

---

#### WARNING

A **WARNING** notice denotes a hazard. It calls attention to an operating procedure, practice, or the like that, if not correctly performed or adhered to, could result in personal injury or death. Do not proceed beyond a **WARNING** notice until the indicated conditions are fully understood and met.

---

## Restricted Rights Legend

The Software and Documentation have been developed entirely at private expense. They are delivered and licensed as "commercial computer software" as defined in DFARS 252.227-7013 (Oct 1988), DFARS 252.211-7015 (May 1991), or DFARS 252.227-7014 (Jun 1995), as a "commercial item" as defined in FAR 2.101(a) or as "restricted computer software" as defined in FAR 25.227-19 (Jun 1987) (or any equivalent agency regulation or contract clause), whichever is applicable. The End User has only those rights provided for such Software and Documentation by the applicable FAR or DFARS clause or the Quonset Microwave standard software agreement for the product involved.

## General Warranty

The material contained in this document is provided "as is," and is subjected to being changed, without notice, in future editions. Further, to the maximum extent permitted by applicable law, Quonset Microwave disclaims all warranties, either expressed or implied with regard to this manual and any information contained herein, including but not limited to the implied warranties of merchantability and fitness for a particular purpose. Quonset Microwave shall not be liable for errors or for incidental or consequential damages in connection with the furnishing, use, or performance of this document or any information contained herein. Should Quonset Microwave and the user have a separate written agreement with warranty terms covering the material in this document that conflict with these terms, the warranty terms in the separate agreement shall control. Duration and conditions of warranty for this product may be superseded when the product is integrated into (becomes part of) other Quonset Microwave products. During the warranty period, Quonset Microwave will, at its option, either repair or replace products which prove to be defective. The warranty period begins on the date of delivery or on the date of installation if installed by Quonset Microwave.

## Product Safety

The following general safety precautions must be observed during all phases of operation of this device. Failure to comply with these precautions or with specific warnings elsewhere in this manual violates safety standards of design, manufacture, and intended use of this device. Quonset Microwave assumes no liability for the customer's failure to comply with these requirements.

## Safety Notices

---

### CAUTION

A **CAUTION** notice denotes a hazard. It calls attention to an operating procedure, practice, or the like that, if not correctly performed or adhered to, could result in damage to the product or loss of data. Do not proceed beyond a **CAUTION** notice until the indicated conditions are fully understood and met.

---

### WARNING

A **WARNING** notice denotes a hazard. It calls attention to an operating procedure, practice, or the likes that, if not correctly performed or adhered to, could result in personal injury or death. Do not proceed beyond a **WARNING** notice until the indicated conditions are fully understood and met.

---

### Personal Safety Considerations

This is a Safety Class I product (provided with a protective earthing ground incorporated in the power cord). The mains plug shall only be inserted in a socket outlet provided with a protective earth contact. Any interruption of the protective conductor, inside or outside the product, is likely to make the product dangerous. Intentional interruption is prohibited. If this product is not used as specified, the protection provided by the equipment could be impaired. This product must be used in a normal condition (in which all means of protection are intact) only.

No operator serviceable parts inside. Refer servicing to qualified personnel. To prevent electrical shock, do not remove covers. For continued protection against fire hazard, replace the line fuse(s) only with fuses of the same type and rating (for example, normal blow, time delay, etc.). The use of other fuses or material is prohibited.

### General Safety Information

The following general safety precautions must be observed during all phases of operation of this product. Failure to comply with these precautions or with specific warnings elsewhere in this manual or any manual associated with this product violates safety standards of design, manufacture, and intended use of the product. Quonset Microwave assumes no liability for the customer's failure to comply with these requirements.

---

## WARNING

**BEFORE APPLYING POWER TO THIS PRODUCT OR MAKING ANY CONNECTIONS TO THIS PRODUCT ensure that all instruments are connected to the protective (earth) ground. Any interruption of the protective earth grounding will cause a potential shock hazard that could result in personal injury or death.**

---

## CAUTION

- Use this device with the cables provided.
  - Do not attempt to service this device. This device should be returned to Quonset Microwave for any service or repairs.
  - Do not open the device.
- 

### User Environment

**This instrument is designed for *indoor* use only.**

## Markings

The following markings may appear on the equipment or in any related documentation.



This marking indicates that a device, or part of a device, may be susceptible to electrostatic discharges (ESD) which can result in damage to the product. Observed ESD precautions given on the product, or in its user documentation, when handling equipment bearing this mark.



This marking indicates that the device complies with applicable sections of part 15 of the FCC rules.



This marking indicates that the device conforms with applicable EC directives.



This marking indicates that the device complies with the Virtual Instrument Software Architecture (VISA) specification.



This marking indicates that the device complies with the Standard Commands for Programmable Instrumentation (SCPI) specification.



This marking indicates that the device complies with the USB Test & Measurement Class (USB TMC) and the USB 488 subclass specifications.



This marking indicates that the device communicates over the Universal Serial Bus (USB).



This marking indicates that the device communicates over Ethernet.

# Revision Control

<b>Revision</b>	<b>Description of Changes</b>	<b>Date</b>
0.0.0	Initial Creation	04/05/2019
0.1.0	Updated I/O Specifications	04/10/2019
	Fixed Environment Variable Name in FPGA Firmware Updates	
	Updated FPGA version in FPGA Firmware Updates	



# Contents

Notices . . . . .	i
Manual Part Number . . . . .	i
Edition . . . . .	i
Warranty . . . . .	i
Technology Licenses . . . . .	i
Restricted Rights Legend . . . . .	i
Safety Notices . . . . .	i
Restricted Rights Legend . . . . .	ii
General Warranty . . . . .	ii
Product Safety . . . . .	ii
Safety Notices . . . . .	ii
Personal Safety Considerations . . . . .	iii
General Safety Information . . . . .	iii
User Environment . . . . .	iii
Markings . . . . .	iv
Revision Control . . . . .	v
<b>1 Overview</b>	<b>2</b>
1. Input/Output Specifications . . . . .	3
2. General Description . . . . .	3
3. System Block Diagram . . . . .	4
4. Automatic Attenuation Ramp . . . . .	5
<b>2 External Control</b>	<b>7</b>
1. External Attenuation Control . . . . .	8
<b>3 Firmware Updates</b>	<b>10</b>
1. Introduction . . . . .	11
2. Firmware Update Files . . . . .	11
3. FPGA Firmware Updates . . . . .	12
4. PIC Firmware Updates . . . . .	18
<b>4 Remote Operation</b>	<b>19</b>
1. Introduction . . . . .	21
1.1 USB Configuration . . . . .	21
1.2 Command Syntax . . . . .	21
1.2.1 Mnemonic Forms . . . . .	21
1.2.2 Using a Semicolon(:) . . . . .	21
1.2.3 Using Whitespace . . . . .	21
1.2.4 Using "?" Commands . . . . .	21
1.2.5 Using "*" Commands . . . . .	21



1.3	Diagram Syntax Conventions . . . . .	21
1.4	Default Units . . . . .	22
1.5	Status Reporting . . . . .	22
1.6	SCPI Data Types . . . . .	22
1.6.1	<boolean> Definition . . . . .	22
1.6.2	<character_data> Definition . . . . .	23
1.6.3	<NAN> Definition . . . . .	23
1.6.4	<non-decimal numeric> Definition . . . . .	23
1.6.5	<NRf> Definition . . . . .	23
1.6.6	<NR1> Definition . . . . .	23
1.6.7	<NR2> Definition . . . . .	23
1.6.8	<NR3> Definition . . . . .	24
1.6.9	<numeric_value> Definition . . . . .	24
1.6.10	<string> Definition . . . . .	24
1.7	Input Message Terminators . . . . .	25
1.8	Compliance Information . . . . .	25
1.8.1	IEEE-488.2 Compliance . . . . .	25
1.8.2	USBTMC Compliance . . . . .	25
1.8.3	VISA Compliance . . . . .	26
2.	VISA Descriptors and Configuration . . . . .	27
2.1	USBTMC . . . . .	27
2.1.1	VISA Descriptors . . . . .	27
2.1.2	USBTMC VISA Code Example . . . . .	27
2.2	TCPIP . . . . .	28
2.2.1	VISA Descriptors . . . . .	28
2.2.2	VISA Attributes . . . . .	28
2.2.3	TCPIP VISA Code Example . . . . .	28
<b>5</b>	<b>Control Commands</b> . . . . .	<b>29</b>
1.	Command Quick Reference Guide . . . . .	31
1.1	Common (*) Commands . . . . .	31
1.2	EtherNET Subsystem . . . . .	32
1.3	POWER Subsystem . . . . .	32
1.4	STATus Subsystem . . . . .	33
1.5	SYSTEM Subsystem . . . . .	33
2.	EtherNET Subsystem Command Reference . . . . .	34
2.1	EtherNET:IPADDRESS . . . . .	34
2.2	EtherNET:GATEWAY . . . . .	35
2.3	EtherNET:SUBNET . . . . .	36
2.4	EtherNET:PORT . . . . .	37
3.	POWER Subsystem Command Reference . . . . .	38
3.1	POWER:DOWNATTEN . . . . .	38
3.2	POWER:DOWNATTEN1 . . . . .	39
3.3	POWER:DOWNATTEN2 . . . . .	40
3.4	POWER:EXTernal . . . . .	41
3.5	POWER:RAMP:DELTA . . . . .	42

3.6	POWER:RAMP:ENABLE	43
3.7	POWER:RAMP:TRIGGER	44
3.8	POWER:RAMP:UPATTEN	45
3.9	POWER:RF	46
3.10	POWER:UPATTEN	47
3.11	POWER:UPATTEN1	48
3.12	POWER:UPATTEN2	49
3.13	POWER:UPATTEN3	50
3.14	POWER:UPATTEN4	51
4.	STATus Subsystem Command Reference	52
4.1	STATus:OPERation	52
4.2	STATus:OPERation:CONDition	53
4.3	STATus:OPERation:ENABle	54
4.4	STATus:PRESet	55
4.5	STATus:QUEStionable	56
4.6	STATus:QUEStionable:CONDition	57
4.7	STATus:QUEStionable:ENABle	58
5.	SYSTem Subsystem Command Reference	59
5.1	SYSTem:BOOTSTATE	59
5.2	SYSTem:CURRent	60
5.3	SYSTem:ERRor	61
5.4	SYSTem:FIRMWare	65
5.5	SYSTem:LOADSTATE	66
5.6	SYSTem:READSTATE	67
5.7	SYSTem:SAVESTATE	68
5.8	SYSTem:SERialNUMber	69
5.9	SYSTem:VERSion	70
6.	IEEE 488.2 Command Reference	71
6.1	Introduction	71
6.2	*CLS	72
6.3	*ESE <NRf>	73
6.4	*ESR?	74
6.5	*IDN?	75
6.6	*OPC	76
6.7	*RCL <NRf>	77
6.8	*RST	78
6.9	*SAV <NRf>	79
6.10	*SDS <NRf>	80
6.11	*SRE <NRf>	81
6.12	*STB?	82
6.13	*TST?	83
6.14	*WAI	84
<b>Index</b>		<b>85</b>

# List of Tables

1.1	Input/Output Specifications . . . . .	3
2.1	Rear-panel Logic Control Pinout . . . . .	9
3.1	FPGA Firmware Revision History . . . . .	11
3.2	PIC Firmware Revision History . . . . .	11
4.2	Default Units . . . . .	22
5.1	Common (*) Commands Summary . . . . .	31
5.2	EtherNET Subsystem Commands Summary . . . . .	32
5.3	POWER Subsystem Commands Summary . . . . .	32
5.4	STATus Subsystem Commands Summary . . . . .	33
5.5	SYSTem Subsystem Commands Summary . . . . .	33
5.6	Error Codes and Messages . . . . .	61
5.7	IEEE 488.2 Common commands . . . . .	71
5.8	*ESE bit mapping . . . . .	73
5.9	*ESR? mapping . . . . .	74
5.10	*OPC mapping . . . . .	76
5.11	*SRE bit mapping . . . . .	81
5.12	*STB? mapping . . . . .	82

# List of Figures

1.1	System Block Diagram . . . . .	4
1.2	Attenuation Ramp . . . . .	6
2.1	DB-37 Logic Connector . . . . .	8
3.1	iMPACT: Automatically Create Project . . . . .	13
3.2	iMPACT: Manually Create Project . . . . .	13
3.3	iMPACT: Boundary Scan . . . . .	14
3.4	iMPACT: Assign Configuration Files . . . . .	14
3.5	iMPACT: Attach PROM . . . . .	15
3.6	iMPACT: Configure PROM . . . . .	15
3.7	iMPACT: FPGA Programming Properties . . . . .	16
3.8	iMPACT: FLASH Programming Properties . . . . .	16
3.9	iMPACT: Programming . . . . .	17
3.10	iMPACT: Program Succeeded . . . . .	17
3.11	CCSLOAD: PIC Programming . . . . .	18



# 1 Overview

## In This Chapter

1. Input/Output Specifications . . . . .	3
2. General Description . . . . .	3
3. System Block Diagram . . . . .	4
4. Automatic Attenuation Ramp . . . . .	5

## 1. Input/Output Specifications

**Table 1.1:** Input/Output Specifications

Parameter	Min	Typ	Max	Unit
External LO Input				
Frequency		8565		MHz
Power Level	10		13	dBm
Upconverter IF Input				
Frequency	950		1450	MHz
Power Level (absolute maximum)			9	dBm
Downconverter RF Input				
Frequency	9.515		10.015	GHz
Power Level (absolute maximum)			-5	dBm
Upconverter RF Output @ 0 dB attenuation				
Frequency	9.515		10.015	GHz
Gain	5		12	dB
Maximum Output Power Level		5		dBm
Downconverter IF Output @ 0 dB attenuation				
Frequency	950		1450	MHz
Gain	30	35	44	dB
Maximum Output Power Level		15		dBm

## 2. General Description

The QM1007-9765-1200 is a Single-Channel, Single-Stage Up/Downconverter. The QM1007-9765-1200 is designed for fixed frequency applications, such as X-band radar test sets. The QM1007-9765-1200 operates with an RF center frequency of 9765 MHz and an IF center frequency of 1200 MHz with a bandwidth of 500 MHz. Other frequency plans are available upon request.

Internal attenuators are included in all of the QM1007-9765-1200 units on both transmit and receive to extend the dynamic range on transmit and receive. The QM1007-9765-1200 units provide 124.5 dB transmit attenuation control, which is useful for target simulation, and 62.5 dB receive attenuation control. Both transmit and receive attenuation may be controlled statically via software commands or external TTL connector inputs. The transmit attenuation may also be programmed to automatically follow an exponential time profile, triggered by a TTL pulse-repetition-interval (PRI).

The QM1007-9765-1200 is controlled via the USB or TCP/IP port as a USBTMC or TCPIP device using VISA protocol, enabling seamless integration into Windows®, Linux®, and Macintosh® environments. A Windows® GUI is provided. External TTL control is also provided for time-varying attenuation control, frequency switching, etc.

### 3. System Block Diagram

A system block diagram for the QM1007-9765-1200 Single-Channel, Single-Stage Up/Downconverter is shown in Figure 1.1. Internal attenuators in the upconverter and downconverter blocks are controlled digitally via an FPGA and microcontroller, which interfaces to a PC through USB or TCP/IP. The microcontroller outputs basic status messages on a 32-character Liquid Crystal Display (LCD) mounted on the faceplate of the unit. An internal low phase noise 100 MHz reference clock is phase-locked to all of the internal LOs, with a BNC-F connector providing the option for LOs to lock to a user-provided 100 MHz external reference. Two additional BNC-F connectors output an internally-generated 10 MHz and 100 MHz reference for use by external test equipment. An external 2.5 GHz LO2 is provided to the VST for phase locking. Switching between the internal and external LO reference clocks is controlled either by the microcontroller or a reference selector switch. The LO1 signal may be provided externally, and the selection between internal and external LO1 is provided by a back-panel switch. When the internal LO1 setting is used, the LO1 signal is also output on the external LO1 connector for multi-channel or MIMO applications. A DB-37 connector is provided on the back panel for fast-tuning of the up-converter and down-converter attenuators via TTL hardware control as well as providing status bits.

For target generation applications, the transmit attenuation may be controlled automatically in real-time via internal FPGA control. An external pulse repetition interval (PRI) trigger is provided via the 37-pin DB-37 connector, which triggers the automatic transmit attenuation control. Optionally, the transmit and receive attenuation may be programmed to static values via either the provided control GUI or VISA commands over the USB or TCP/IP interface. Static attenuation may also be set by rear-panel DB-37 control.

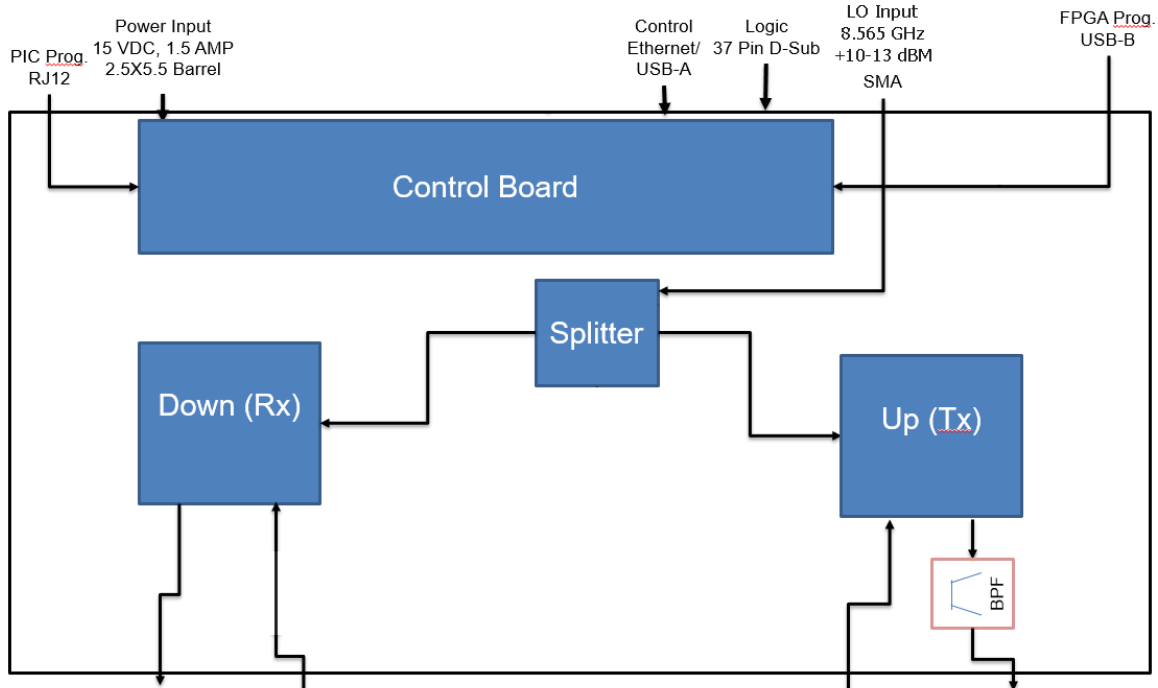

**Figure 1.1:** System Block Diagram

## 4. Automatic Attenuation Ramp

A key feature of the QM1007-9765-1200 is the ability to automatically ramp the transmit attenuation for target simulation. The QM1007-9765-1200 upconverter contains a total of four upconverter RF attenuators providing 124.5 dB of transmit attenuation in 0.5 dB steps. The individual attenuators or the total attenuation may be set manually via software control. However, the QM1007-9765-1200 also provides the ability to automatically adjust the attenuation to simulate the reflection from either a single target or multiple targets at various ranges. This feature is useful because the 124.5 total attenuation of the QM1007 increases the dynamic range of the VST signal generator. The attenuation may be automatically triggered to increase exponentially in time in response to either an external TTL trigger or a software trigger.

In a pulsed radar system, the range to a target is indicated by the time delay of the reflected radar pulse from the time the pulse was transmitted. The power received back at the radar receiver decays as  $1/R^4$  due to spherical spreading of the transmitted waveform and the reflected signal from the target. Since range is linearly proportional to time, it is also true that the power received at the receiver decays as  $1/t^4$ . In decibels, we can express the received power vs time as:

$$Pr = -40 * \log_{10}(t/t_0),$$

where  $t_0$  is an arbitrary time specified. Hence, the decrease in power is related to the time ratio from an arbitrary point in time (or space) away from the radar. Mathematically, the relation  $P_r \sim 1/R^4$  would seem to indicate that power is infinite at the radar, which we know is not true. This expression is only valid in the "far field" a certain distance away from the radar. Hence, we need to specify an arbitrary initial time  $t_0$  for applying the attenuation profile.

Now since the received power is specified as above, in order to simulate this exponential decay of the radar pulse we need to apply an attenuation curve that is the inverse of the power relation. That is, the attenuation gets applied as  $R^4$  relative to the start of the transmit pulse. A TTL trigger corresponding to the radar's pulse repetition interval (PRI) is needed to apply and switch the attenuation at the appropriate time.



Figure 1.2 below shows two curves. The arbitrary time reference  $t_0$  is set to  $1 \mu\text{s}$ , where the gain is flat with no attenuation applied till  $t_0$ . The red dotted curve corresponds to the radar's power received,  $P_r$ , while the blue solid curve corresponds to the applied attenuation to simulate a target amplitude at various ranges. With  $t_0$  set to  $1 \mu\text{s}$ , we note that the maximum attenuation of 124.5 dB is achieved in about 1.3 ms.

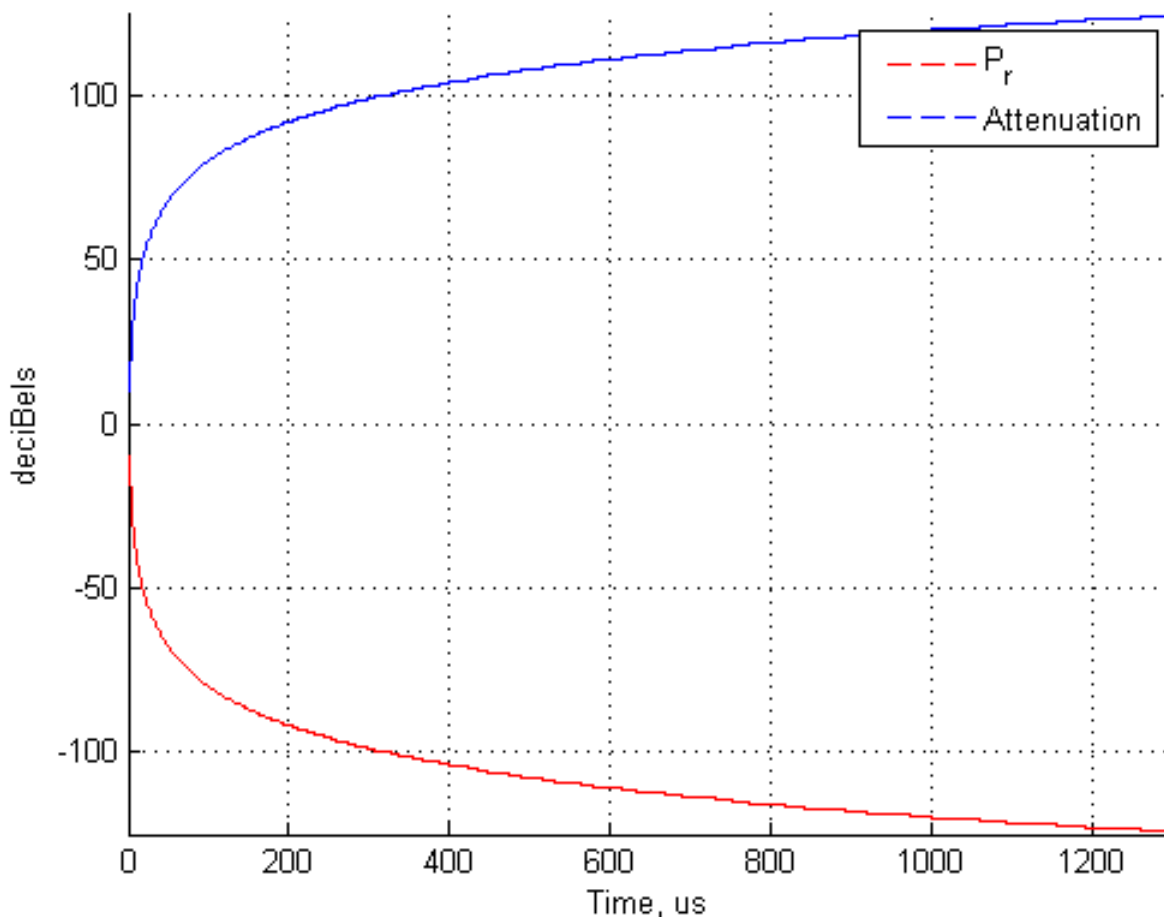

**Figure 1.2:** Attenuation Ramp



# 2 External Control

## In This Chapter

1. External Attenuation Control . . . . .	8
---	---

## 1. External Attenuation Control

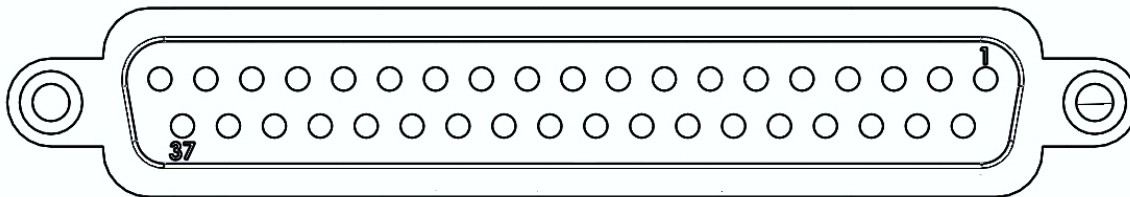

**Figure 2.1:** DB-37 Logic Connector

The receive and transmit attenuation of the Single-Channel, Single-Stage Up/Downconverter can be controlled using external TTL logic through the rear-panel DB-37 connector, shown in Figure 2.1. Refer to Table 2.1 for a mapping of control signal to connector pin.

### **PRI\_External\_Trigger**

When External Attenuation Control is Enabled (POWER:EXTernal, page 41) and Attenuation Ramp Mode is Enabled (POWER:RAMP:ENABLE, page 43), a logic high on this pin triggers an attenuation ramp to reset and start the programmed exponential attenuation profile vs. time. See Automatic Attenuation Ramp for more info.

### **Downconverter\_Attenuation[6:0]**

When External Attenuation Control is Enabled (POWER:EXTernal, page 41) and Attenuation Ramp Mode is Disabled (POWER:RAMP:ENABLE, page 43), static receiver attenuation can be set by inputting a binary value on these pins equivalent to twice the desired attenuation. For example, for an attenuation value of 34.5, the binary value of 69 (7'b1000101) would be applied to Downconverter\_Attenuation[6:0].

### **Upconverter\_Attenuation[7:0]**

When External Attenuation Control is Enabled (POWER:EXTernal, page 41) and Attenuation Ramp Mode is Disabled (POWER:RAMP:ENABLE, page 43), static transmitter attenuation can be set by inputting a binary value on these pins equivalent to twice the desired attenuation. For example, for an attenuation value of 89.5, the binary value of 179 (8'b10110011) would be applied to Upconverter\_Attenuation[7:0].

### **Upconverter\_Ramp\_Attenuation[7:1]**

When Attenuation Ramp Mode is Enabled (POWER:RAMP:ENABLE, page 43), the current value of the transmitter ramp attenuation can be read out on these pins. Because the least significant bit is not included in the output, this value only has a resolution of 1 dB even though the current attenuation value could have a value potentially 0.5 dB higher than what is read out.

### **Upconverter\_Ramp\_Busy**

When Attenuation Ramp Mode is Enabled (POWER:RAMP:ENABLE, page 43), this output pin provides a logic high while the Single-Channel, Single-Stage Up/Downconverter is busy ramping and a logic low between successive ramps.

**Table 2.1:** Rear-panel Logic Control Pinout

<b>Signal</b>	<b>Direction</b>	<b>DB-37 Pin</b>
PRI_External_Trigger	IN	19
Downconverter_Attenuation[0]	IN	37
Downconverter_Attenuation[1]	IN	18
Downconverter_Attenuation[2]	IN	36
Downconverter_Attenuation[3]	IN	17
Downconverter_Attenuation[4]	IN	35
Downconverter_Attenuation[5]	IN	16
Downconverter_Attenuation[6]	IN	34
Upconverter_Attenuation[0]	IN	15
Upconverter_Attenuation[1]	IN	33
Upconverter_Attenuation[2]	IN	14
Upconverter_Attenuation[3]	IN	32
Upconverter_Attenuation[4]	IN	13
Upconverter_Attenuation[5]	IN	31
Upconverter_Attenuation[6]	IN	12
Upconverter_Attenuation[7]	IN	30
<i>Reserved For Future Use</i>	IN	11
<i>Reserved For Future Use</i>	IN	29
<i>Reserved For Future Use</i>	IN	10
<i>Reserved For Future Use</i>	IN	28
<i>Reserved For Future Use</i>	IN	9
<i>Reserved For Future Use</i>	IN	27
<i>Reserved For Future Use</i>	IN	8
<i>Reserved For Future Use</i>	IN	26
Upconverter_Ramp_Attenuation[1]	OUT	7
Upconverter_Ramp_Attenuation[2]	OUT	25
Upconverter_Ramp_Attenuation[3]	OUT	6
Upconverter_Ramp_Attenuation[4]	OUT	24
Upconverter_Ramp_Attenuation[5]	OUT	5
Upconverter_Ramp_Attenuation[6]	OUT	23
Upconverter_Ramp_Attenuation[7]	OUT	4
Upconverter_Ramp_Busy	OUT	22



# 3 Firmware Updates

## In This Chapter

1. Introduction . . . . .	11
2. Firmware Update Files . . . . .	11
3. FPGA Firmware Updates . . . . .	12
4. PIC Firmware Updates . . . . .	18

## 1. Introduction

The QM1007-9765-1200 Single-Channel, Single-Stage Up/Downconverter is continually being improved and may require firmware updates to correct problems in previous firmware versions or to add new features that were not yet implemented in previous firmware versions. Tables 3.2 and 3.1 detail Firmware Revisions that have been released and which features they fixed or introduced.

**Table 3.1:** FPGA Firmware Revision History

FPGA Firmware Version	Reason To Update
v3.1.0	N/A (Initial 9765 MHz Release)

**Table 3.2:** PIC Firmware Revision History

PIC Firmware Version	Reason To Update
v3.3.0	N/A (Initial 9765 MHz Release)

## 2. Firmware Update Files

The required files to perform firmware updates are uploaded onto the Quonset Microwave FTP server and need to be downloaded and extracted to a location on the computer performing the update prior to continuing. Firmware updates can be obtained by clicking the following link or visiting the link in any FTP-capable web browser:

```
ftp://qmguest:QM@quonsetmicrowave.brickftp.com/Firmware/QM1007/
```

The files specific to the QM1007-9765-1200 are the QM1007-014\_vX.X.X.zip files. The zip files contain the necessary files required to perform the firmware updates. PIC Firmware Updates require \*.hex files and FPGA Firmware Updates require both \*.bit files and \*.mcs files. If the firmware update zip file contains all three files, it is recommended to upgrade both PIC and FPGA firmware versions to ensure proper performance as they likely work together and require each other for correct interaction.

### 3. FPGA Firmware Updates

The QM1007-9765-1200 Control Board uses a Macronix™ serial flash and a Xilinx® FPGA. Macronix™ serial flash are not currently supported by the Xilinx® iMPACT programming tool. The following sections demonstrate the steps required to successfully configure the iMPACT software and load a Macronix™ flash.

#### **Xilinx® iMPACT**

Xilinx® iMPACT Standalone Programmer is included in the Xilinx® ISE Lab Tools and is used in this guide. ISE Lab Tools are available for free download using the following link:

[https://www.xilinx.com/member/forms/download/xef.html?filename=Xilinx\\_LabTools\\_14.4\\_P.49d.3.0.tar](https://www.xilinx.com/member/forms/download/xef.html?filename=Xilinx_LabTools_14.4_P.49d.3.0.tar)

**Note:** All Xilinx® software downloads require Name and Address Verification in compliance with U.S. Government Export Regulations prior to downloading.

#### **System Environment Variable**

A system environment variable must be set to allow the iMPACT software to skip its ID Check of the Macronix™ flash. In Microsoft Windows, this is done through System Properties. In Microsoft Windows 10, click the Start Button and type "Edit the system environment variables" and click on the "Environment Variables" button. The Environment Variables window is divided into two sections, User Variables and System Variables. A new System Environment Variable must be created by clicking "New" in the System Variables section. In the New System Variable window, enter the following:

Variable name: XIL\_IMPACT\_SKIPIDCODECHECK

Variable value: 1

#### **USB Cable Connection**

A standard USB 2.0 A-Male to B-Male Cable can be used to connect the computer to the QM1007-9765-1200. The A-Male end of the cable connects to the computer and the B-Male end of the cable connects to the QM1007-9765-1200 in the port on the back panel labeled FPGA PROG.

## Programming with iMPACT

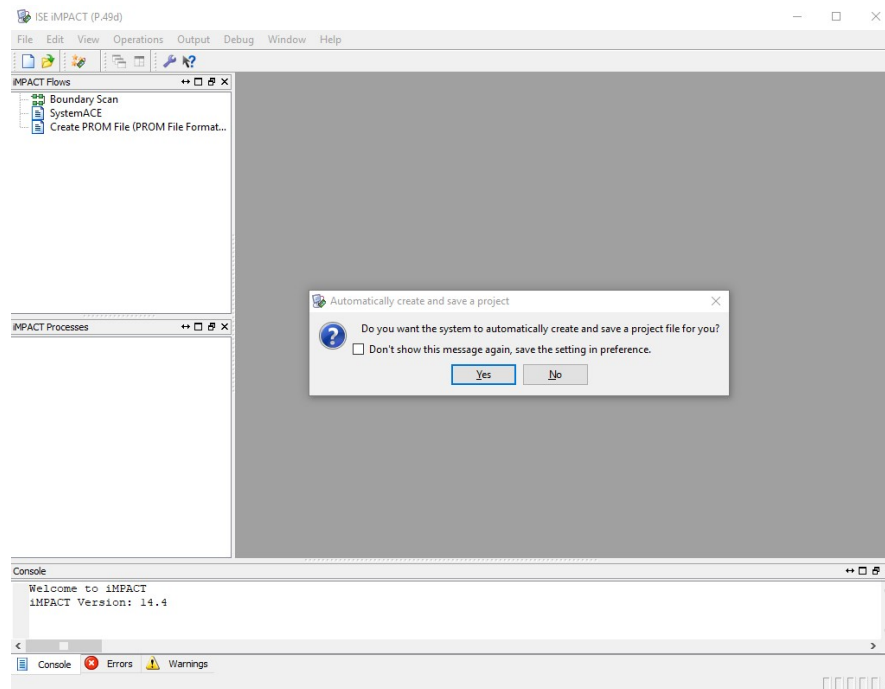

**Figure 3.1:** iMPACT: Automatically Create Project

When iMPACT is started, it will first ask if you want it to create and save a project file for you. Choose 'No', as reusing projects sometimes results in outdated files being programmed, which were saved in previous sessions.

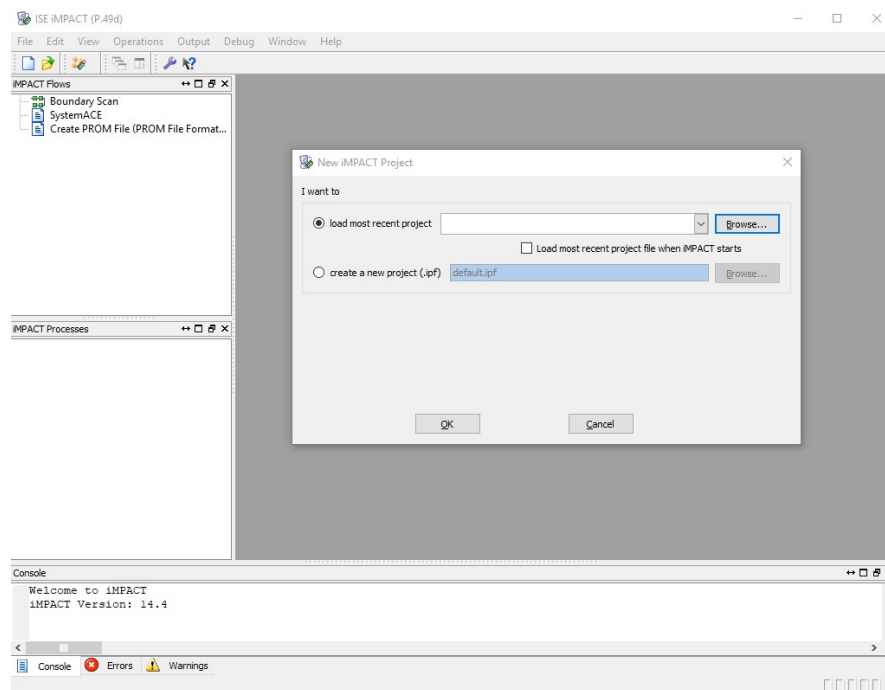

**Figure 3.2:** iMPACT: Manually Create Project

Similarly, select 'Cancel' when it asks you to load or create a new project next.



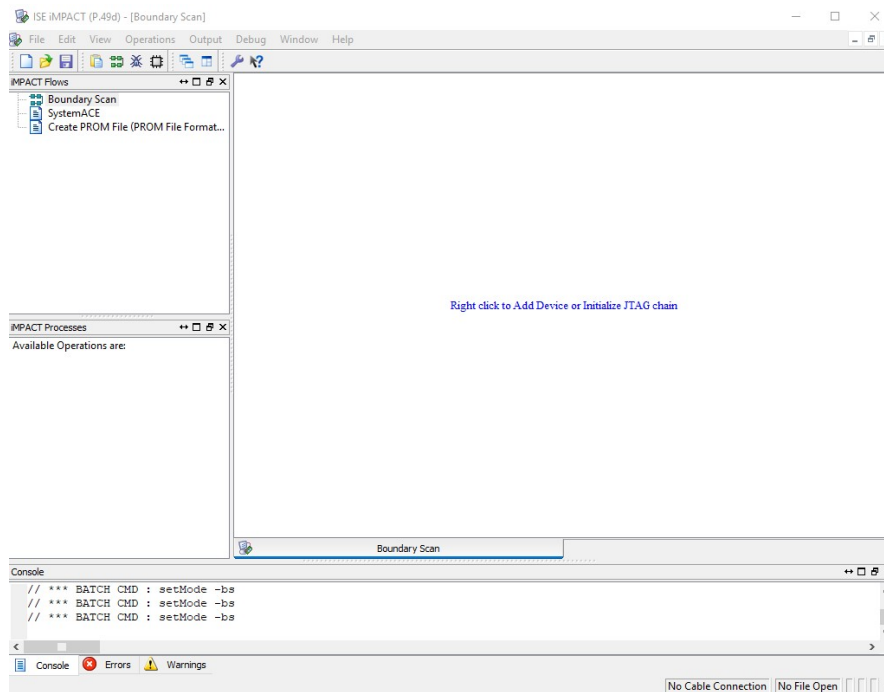

**Figure 3.3: iMPACT: Boundary Scan**

Double-click 'Boundary Scan' in the upper-left of the program. This will open a Boundary Scan window, which is where we interact with the device.

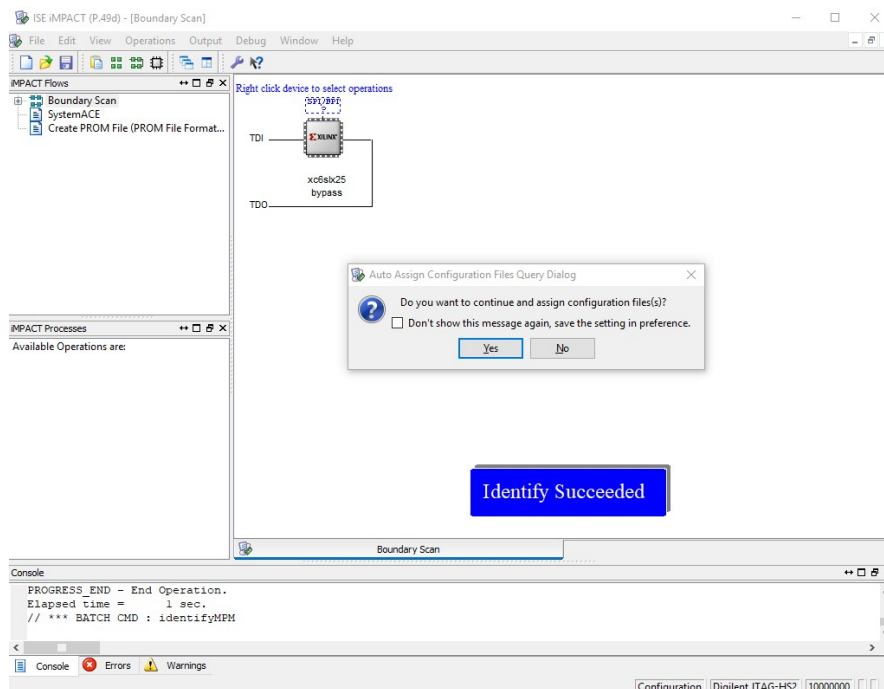

**Figure 3.4: iMPACT: Assign Configuration Files**

Right-click in the Boundary Scan window and select 'Initialize Chain', which will search for the target device. After the device is found, choose 'Yes' when it asks if you want to assign configuration files.

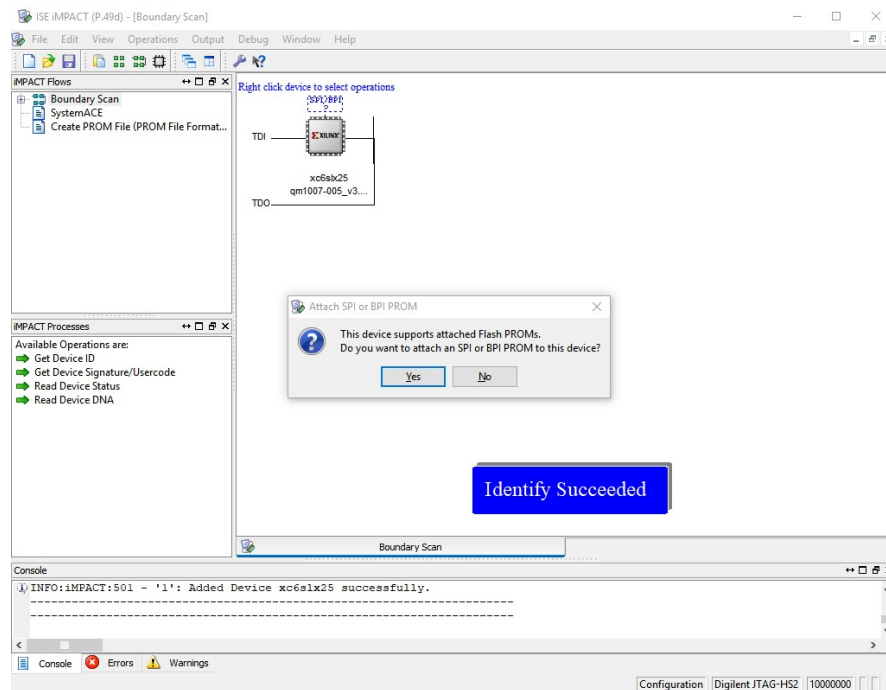

**Figure 3.5:** iMPACT: Attach PROM

Select the QM1007-005\_vX.X.X.bit file provided and the text under the device will change from 'Bypass' to qm1007-005\_v3.X.X.bit and it will ask if you want to attach a PROM. Choose 'Yes'.

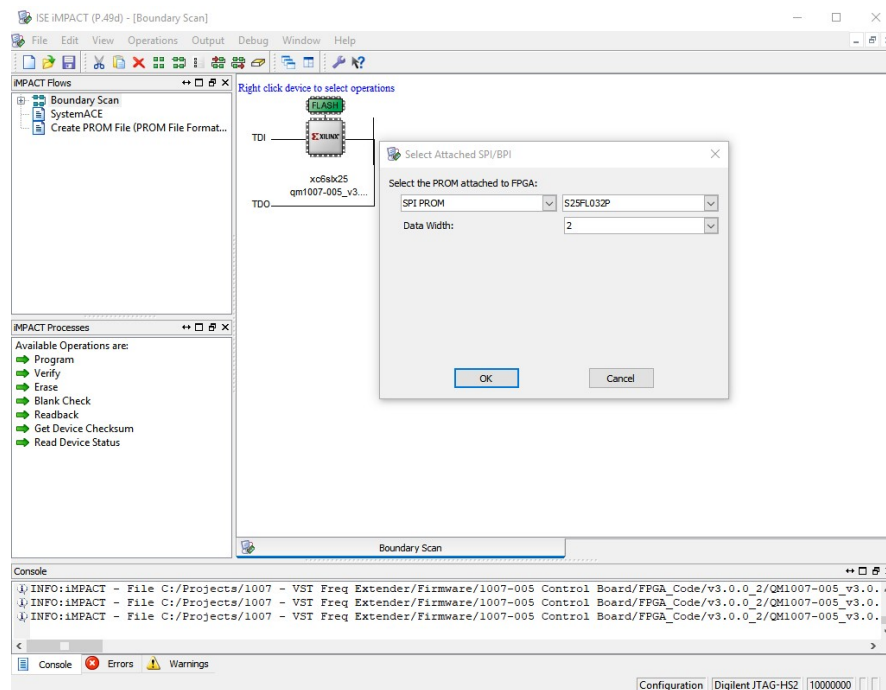

**Figure 3.6:** iMPACT: Configure PROM

Select the QM1007-005\_vX.X.X.mcs file provided and it will ask you to configure the PROM. Select 'SN25FL032P' for the device and '2' for the data width as shown.

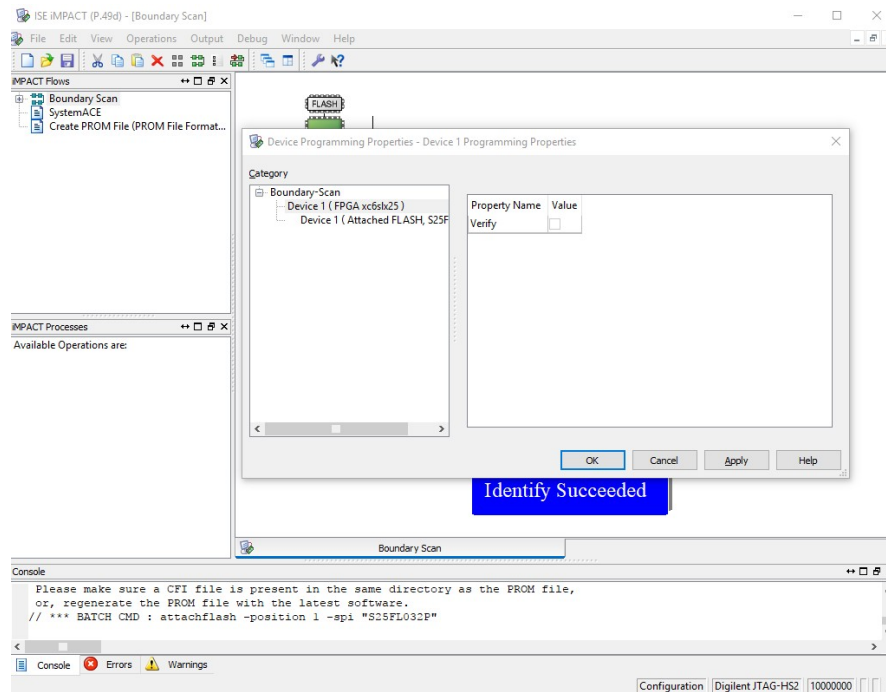

**Figure 3.7:** iMPACT: FPGA Programming Properties

On the first Device Programming Properties screen, leave the box to verify the FPGA write unchecked and click 'OK'.

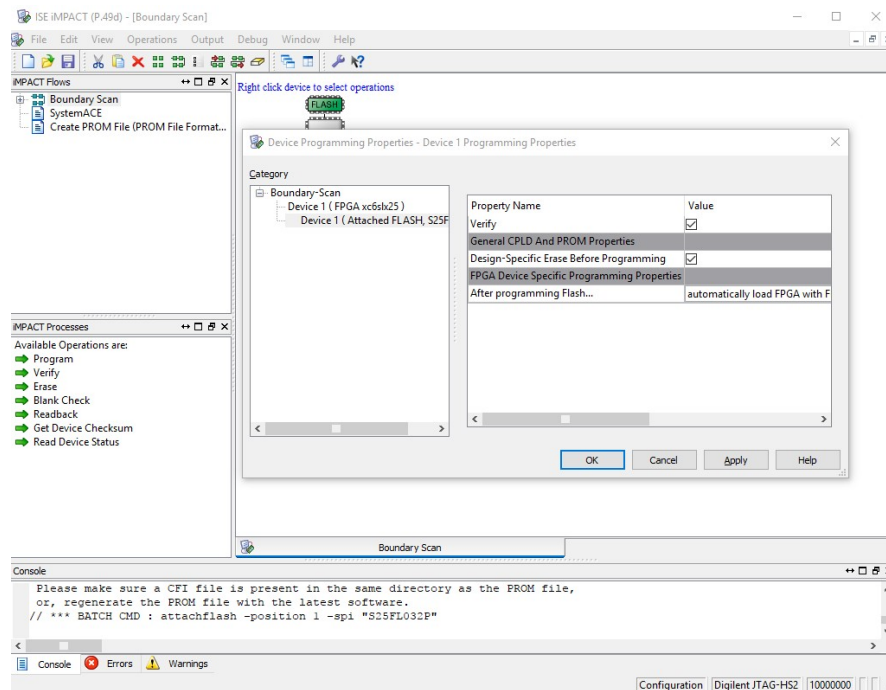

**Figure 3.8:** iMPACT: FLASH Programming Properties

Right-click the FLASH icon and click Program, which will open the Device Programming Properties for the PROM. Leave Verify and Erase Before Programming both checked, and leave the After Programming selection set to automatically load FPGA when finished (all defaults) and click 'OK'.

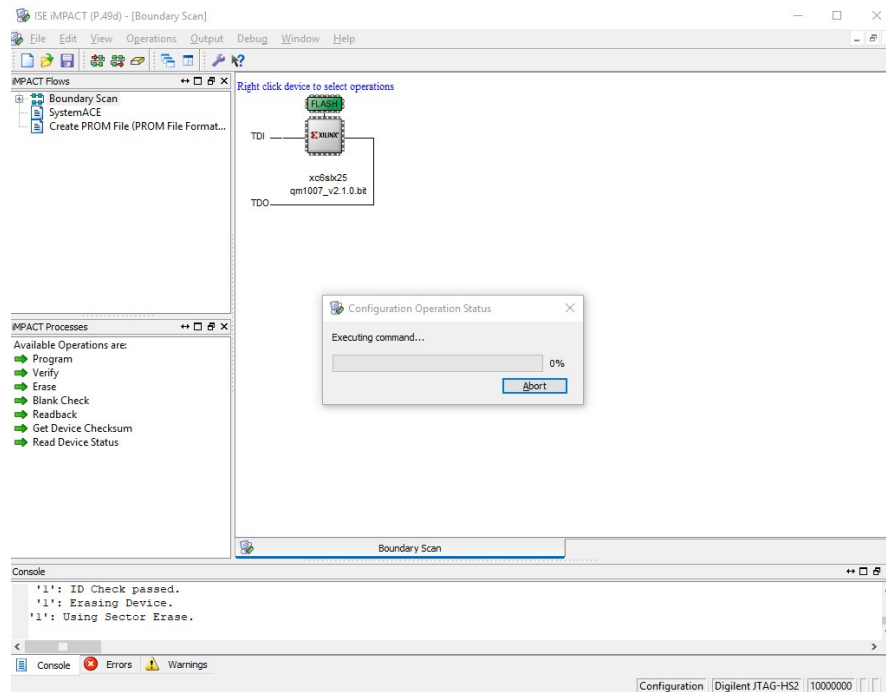

**Figure 3.9:** iMPACT: Programming

The erase and write operations will begin and show a Configuration Operation Status bar.

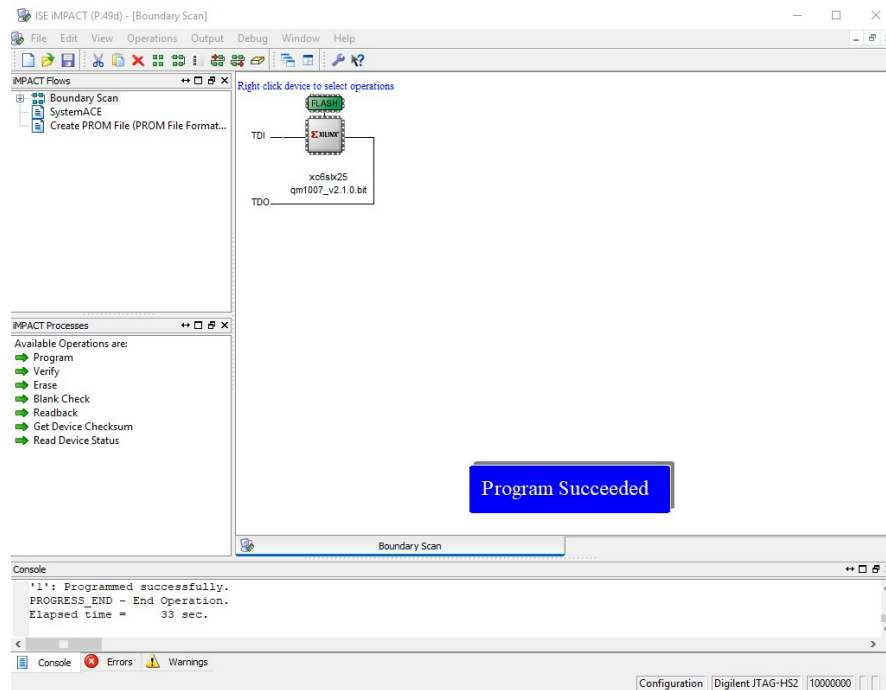
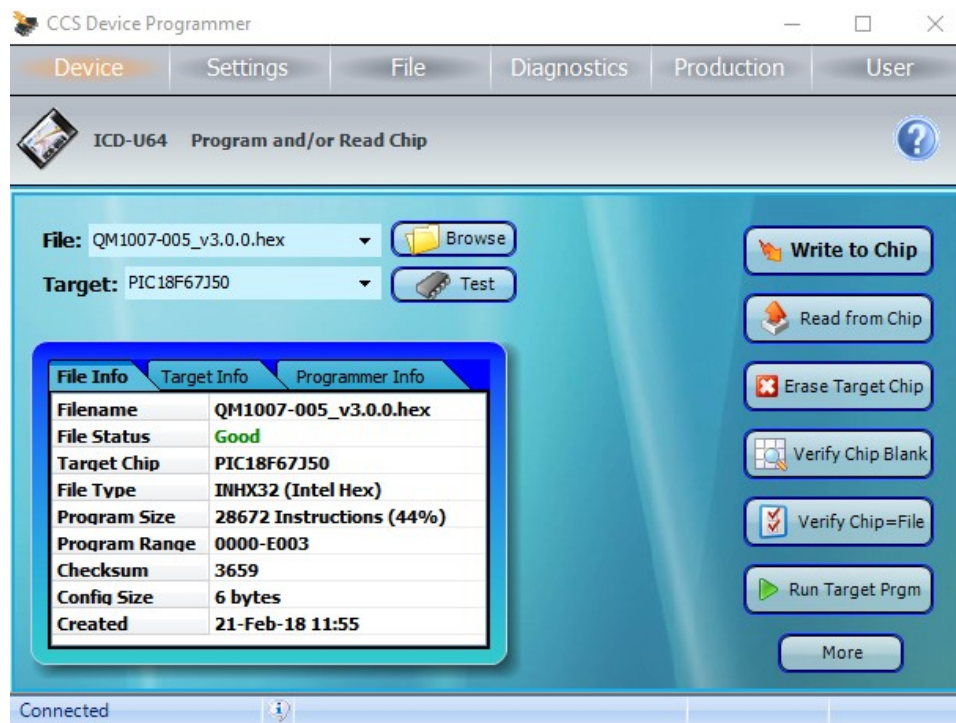

**Figure 3.10:** iMPACT: Program Succeeded

The status will go up to 26% before completing and displaying 'Program Succeeded'. This PROM write took 33 seconds, which is typical for a PROM write to this device. The Single-Channel, Single-Stage Up/Downconverter should then be power-cycled, as the image is loaded to the FPGA on power-up by the PIC.

## 4. PIC Firmware Updates

The QM1007-9765-1200 Control Board uses a Microchip Technology, Inc. PIC18F67J50 processor. The PIC Firmware update process is performed using a Custom Computer Services, Inc. (CCS) ICD-U64 Debugger/Programmer, but can be done using any In-Circuit Serial Programmer (ICSP) with an RJ-12 connection that supports the Microchip PIC18F67J50 device. The ICD-U64 from CCS includes the CCSLOAD free programmer control software, which is used to load the update.



**Figure 3.11: CCSLOAD: PIC Programming**

After opening CCSLOAD, simply click 'Browse' and select the QM1007-005\_vX.X.X.hex file and click 'Write to Chip'. When complete, the status in the bottom left will change from 'Connected' to 'Target Programmed'. After programming, either close CCSLOAD or click 'Run Target Prgm' to run the new version.



# 4 Remote Operation

## In This Chapter

1.	Introduction . . . . .	21
1.1	USB Configuration . . . . .	21
1.2	Command Syntax . . . . .	21
1.2.1	Mnemonic Forms . . . . .	21
1.2.2	Using a Semicolon(;) . . . . .	21
1.2.3	Using Whitespace . . . . .	21
1.2.4	Using "?" Commands . . . . .	21
1.2.5	Using "*" Commands . . . . .	21
1.3	Diagram Syntax Conventions . . . . .	21
1.4	Default Units . . . . .	22
1.5	Status Reporting . . . . .	22
1.6	SCPI Data Types . . . . .	22
1.6.1	<boolean> Definition . . . . .	22
1.6.2	<character_data> Definition . . . . .	23
1.6.3	<NAN> Definition . . . . .	23
1.6.4	<non-decimal numeric> Definition . . . . .	23
1.6.5	<NRf> Definition . . . . .	23
1.6.6	<NR1> Definition . . . . .	23
1.6.7	<NR2> Definition . . . . .	23
1.6.8	<NR3> Definition . . . . .	24
1.6.9	<numeric_value> Definition . . . . .	24
1.6.10	<string> Definition . . . . .	24
1.7	Input Message Terminators . . . . .	25
1.8	Compliance Information . . . . .	25
1.8.1	IEEE-488.2 Compliance . . . . .	25
1.8.2	USBTMC Compliance . . . . .	25

1.8.3 VISA Compliance . . . . . 26

2. VISA Descriptors and Configuration . . . . . 27

2.1 USBTMC . . . . . 27

2.1.1 VISA Descriptors . . . . . 27

2.1.2 USBTMC VISA Code Example . . . . . 27

2.2 TCPIP . . . . . 28

2.2.1 VISA Descriptors . . . . . 28

2.2.2 VISA Attributes . . . . . 28

2.2.3 TCPIP VISA Code Example . . . . . 28

*The following markings apply to the QM1007-9765-1200 Single-Channel, Single-Stage Up/Downconverter family of products.*

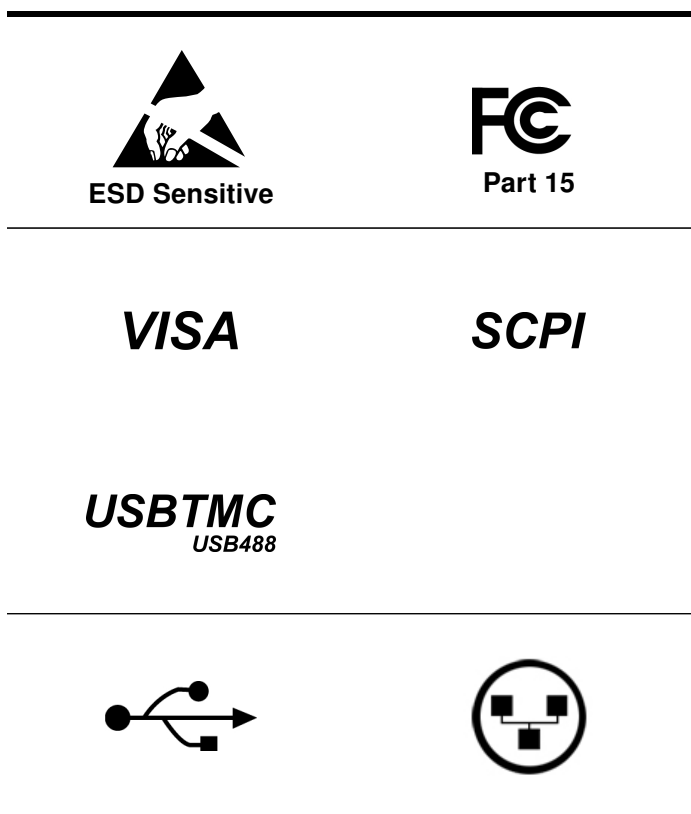

## 1. Introduction

### 1.1 USB Configuration

The Quonset Microwave QM1007-9765-1200 Single-Channel, Single-Stage Up/Downconverter has been designed to configure as a USBTMC or TCPIP device. No additional drivers are required.

The QM1007-9765-1200 has been designed to be VISA and SCPI compliant and as such, all you need in order to communicate with the Single-Channel, Single-Stage Up/Downconverter is a VISA library installed on your machine. The QM1007-9765-1200 has been designed using the NI-VISA Runtime Engine, which is included with the GUI.

### 1.2 Command Syntax

In this manual, the following command syntax conventions are used:

- Square brackets ([ ]) indicate multiple keywords, one of which must be used
- Bars(|) can be read as "or" and are used to separate parameter options.

#### 1.2.1 Mnemonic Forms

Each keyword has both a long and short form. A standard notation is used to differentiate the short form and long form keyword. The long form of the keyword is shown, with the short form of the keyword shown in uppercase letters and the rest of the keyword is shown in lowercase letters. For example, the short form of *FREQuency* is *FREQ*.

#### 1.2.2 Using a Semicolon(;)

Use a semicolon to separate two commands within the same command string.

#### 1.2.3 Using Whitespace

You *must* use whitespace characters, [tab], or [space] to separate a parameter from a keyword.

#### 1.2.4 Using "?" Commands

The bus controller may send commands at any time, but a SCPI instrument may only send a response when specifically instructed to do so. Only commands that end with a "?", henceforth referred to as queries, instruct the instrument to send a response message. Queries can return either measured values, instrument settings, or internal status codes.

**Note:** *If you send multiple queries without reading the response between queries, only the result of the last query will be returned when the response is read. The query buffer is a first-in first-out configuration.*

#### 1.2.5 Using "\*" Commands

Commands starting with a "\*" are called common commands. They are required to perform identical functions for all instruments that are compliant with the IEEE-488.2 interface standard. The "\*" commands are used to control reset, self-test, and status operations in the Single-Channel, Single-Stage Up/Downconverter.

### 1.3 Diagram Syntax Conventions

- Solid lines represent the recommended path
- Ovals enclose command mnemonics. The command mnemonic must be entered exactly as shown in the oval.



- Dotted lines indicate an optional path for passing secondary or optional keywords.
- Arrows and curved intersections indicate command path direction.
- All diagrams flow from left to right. A path may not travel to the left except in a bypass loop.

#### 1.4 Default Units

Unless otherwise specified, the following units are assumed:

**Table 4.2:** Default Units

Current	A
Frequency	GHz
Power	dBm
Time	$\mu$ s
Temperature	°C
Voltage	Volts

#### 1.5 Status Reporting

Status reporting is used to monitor the Single-Channel, Single-Stage Up/Downconverter to determine which events have occurred. Status reporting is accomplished by configuring and reading status registers.

The Single-Channel, Single-Stage Up/Downconverter has the following main registers:

- Status Register
- Standard Event Register
- Operation Status Register
- Questionable Status Register
- Device Status Register

Status and Standard Event registers are read using the IEEE-488.2 common commands.

Operation and Questionable Status registers are read using the SCPI *STAT* subsystem.

#### 1.6 SCPI Data Types

The SCPI language defines different formats for use in program messages and response messages. Instruments are flexible listeners and can accept commands and parameters in various formats. However, SCPI instruments are precise talkers. This means that SCPI instruments *always* responds to a particular query in a predefined, rigid format.

##### 1.6.1 <boolean> Definition

Throughout this document <*boolean*> is used to represent *ON|OFF* <*NRf*>. Boolean parameters have a value of 0 or 1 and are unitless. *ON* corresponds to 1 and *OFF* corresponds to 0.

On input, an <*NRf*> is rounded to an integer. A nonzero result is interpreted as 1.

Queries always return a 1 or a 0, never *ON* or *OFF*.

**1.6.2 <character\_data> Definition**

Throughout this document, <character\_data> is used to represent character data, that is, A-Z, a-z, 0-9 and \_ (underscore). STOP and A4\_U2 are examples of character data. The first character must be alphanumeric, followed by either alphanumeric or underscore characters up to a maximum of 12 characters.

**1.6.3 <NAN> Definition**

Not a number (NAN) is represented as 9.91 E37. Not a number is defined in IEEE 754.

**1.6.4 <non-decimal numeric> Definition**

Throughout this document, <non-decimal numeric> is used to represent numeric information in bases other than 10 (that is, hexadecimal, octal, and binary). Examples of non-decimal numeric include #HFF4, #hff4, #Q25, #q25, and #B101011.

**1.6.5 <NRf> Definition**

Throughout this document, <NRf> is used to denote a flexible numeric representation. The following show examples of <NRf>

- +185
- -10
- +1.2E09

**1.6.6 <NR1> Definition**

Throughout this document, <NR1> numeric response data is defined as:

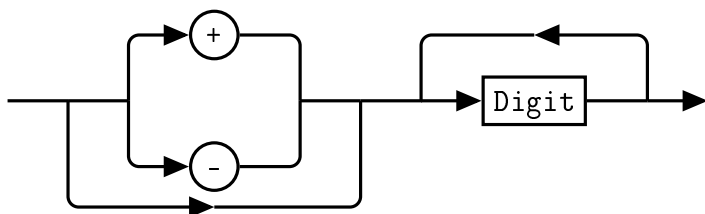

The following shows the examples of <NR1>:

- 127
- +127
- -12345

**1.6.7 <NR2> Definition**

Throughout this document, <NR2> numeric response data is defined as:

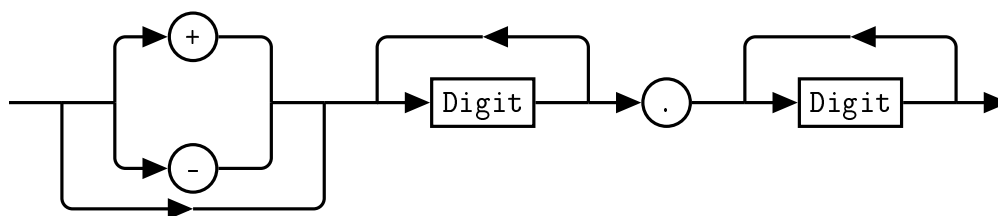

The following shows the examples of <NR2>:

- 12.7
- +127
- -1.2345
- -0.123

### 1.6.8 <NR3> Definition

Throughout this document, <NR3> numeric response data is defined as:

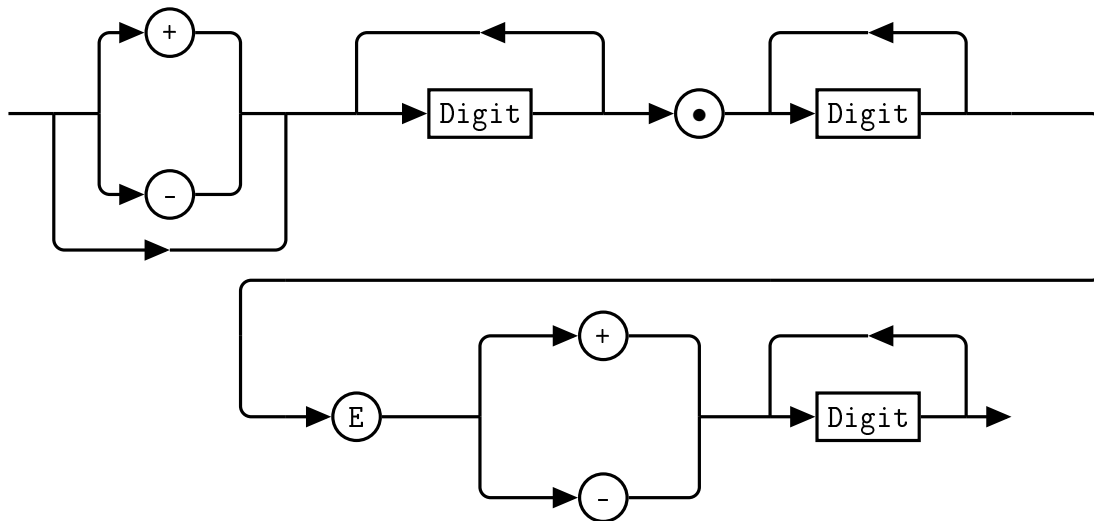

The following shows the examples of <NR3>:

- 1.23E+4
- 12.3E-45

### 1.6.9 <numeric\_value> Definition

Throughout this document, the decimal numeric element is abbreviated to <numeric\_value>.

### 1.6.10 <string> Definition

Throughout this document, <string> is used to represent the 7-bit ASCII characters. The format is defined as:

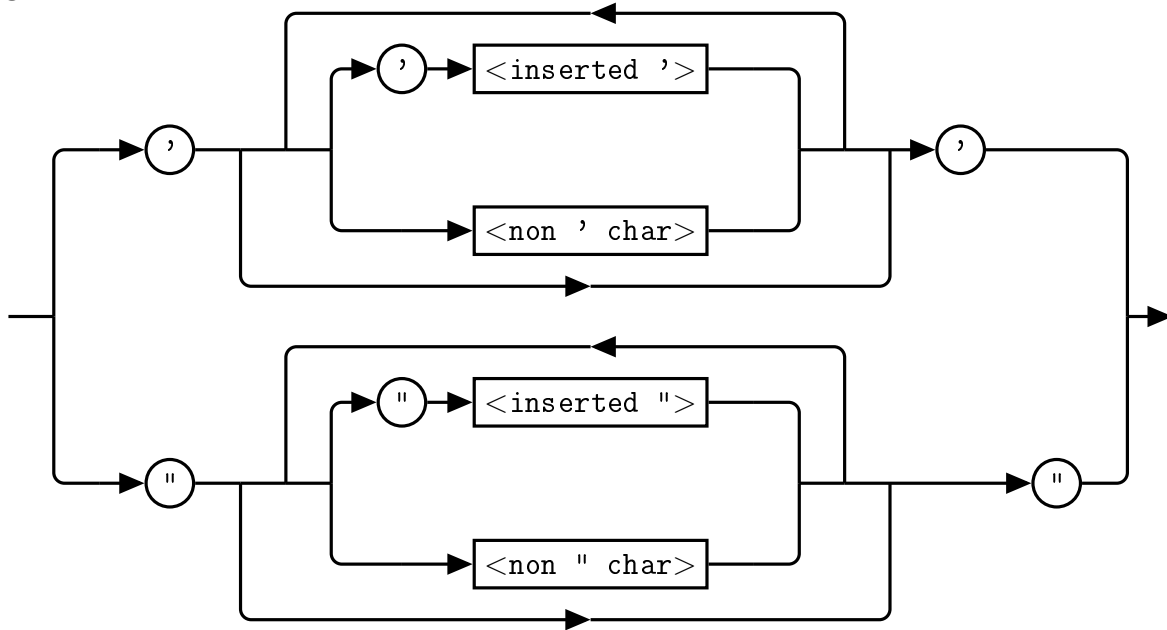
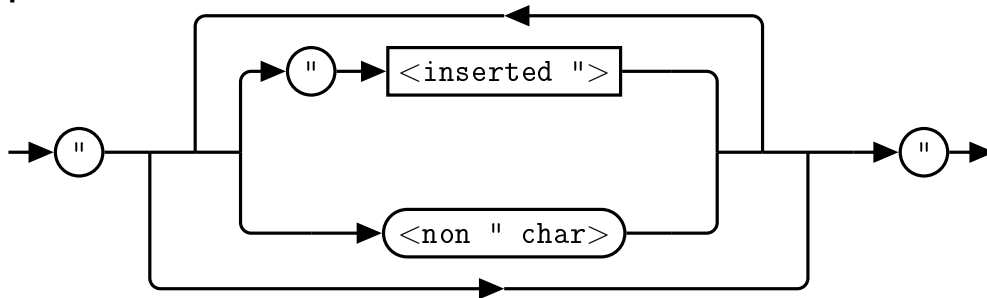
**Program Data****Response Data****1.7 Input Message Terminators**

Program messages sent to a SCPI instrument *must* terminate with a <newline> character. The IEEE.488 EOI (end or identify) signal is interpreted as a <newline> character and may also be used to terminate a message in place of the <newline> character. A <carriage return> followed by a <newline> character is also accepted. Many programming languages allow you to specify a message terminator character or EOI state to be automatically sent with each bus transaction. Message termination *always* sets the current path back to the root-level.

**1.8 Compliance Information****1.8.1 IEEE-488.2 Compliance**

The Single-Channel, Single-Stage Up/Downconverter complies with the rules and regulations of the of the IEEE-488.2 standard which are applicable to USB controlled devices.

**1.8.2 USBTMC Compliance**

The QM1007-9765-1200 Single-Channel, Single-Stage Up/Downconverter complies with the rules and regulations of the of the USBTMC (USB Test and Measurement Class). When connected to a USB bus, the QM1007-9765-1200 will configure as a USB Test and Measurement device.

### **1.8.3 VISA Compliance**

The QM1007-9765-1200 Single-Channel, Single-Stage Up/Downconverter complies with the rules and regulations of the of the VISA (Virtual Instrument Systems Architecture) standard. Communication with the QM1007-9765-1200 is accomplished through VISA libraries, providing portability between different operating systems. *No additional drivers are required.*

## 2. VISA Descriptors and Configuration

### 2.1 USBTMC

#### 2.1.1 VISA Descriptors

To communicate with the Quonset Microwave QM1007-9765-1200 Single-Channel, Single-Stage Up/Downconverter as a USBTMC device, use the following USB VISA descriptor format:

```
USB[board number]::manufacturer ID::model code::serial number::INSTR
```

#### Descriptor Example

```
USB0::0x2012::0x0019::0005::INSTR
```

#### 2.1.2 USBTMC VISA Code Example

```
ViSession rscmng;  
ViSession qm1007;  
char buf[256] = 0;  
  
viOpenDefaultRM(&rscmng);  
viOpen(rscmng,(ViRsrc)"USB0::0x2012::0x0019::0005::INSTR",VI_NULL,VI_NULL,&qm1007);  
viPrintf(qm1007,(ViString)"*IDN?\n");  
viScanf(qm1007,(ViString)"%t",&buf);  
viClose((ViObject)qm1007);  
viClose((ViObject)rscmng);
```

## 2.2 TCPIP

### 2.2.1 VISA Descriptors

To communicate with the Quonset Microwave QM1007-9765-1200 Single-Channel, Single-Stage Up/Downconverter as a TCP/IP device, use the following TCPIP VISA descriptor format:

```
TCPIP::IP address::port number::SOCKET
```

#### Descriptor Example

```
TCPIP::192.168.2.188::5025::SOCKET
```

### 2.2.2 VISA Attributes

When using the TCPIP SOCKET connection, the following two VISA Attributes must be set for communication to work properly:

```
VI_ATTR_TERMCHAR  
VI_ATTR_TERMCHAR_EN
```

The QM1007-9765-1200 Single-Channel, Single-Stage Up/Downconverter uses a newline character ('\n') to indicate end of transmission on query replies and setting these two attributes configures the communicating system to interact properly with the device.

### 2.2.3 TCPIP VISA Code Example

```
ViSession rscmng;  
ViSession qm1007;  
char buf[256] = 0;  
  
viOpenDefaultRM(&rscmng);  
viOpen(rscmng,(ViRsrc)"TCPIP::192.168.2.188::5025::SOCKET",VI_NULL,VI_NULL,&qm1007);  
viSetAttribute(qm1007,VI_ATTR_TERMCHAR,'\n');  
viSetAttribute(qm1007,VI_ATTR_TERMCHAR_EN,VI_TRUE);  
viPrintf(qm1007,(ViString)"*IDN?\n");  
viScanf(qm1007,(ViString)"%t",&buf);  
viClose((ViObject)qm1007);  
viClose((ViObject)rscmng);
```



# 5 Control Commands

## In This Chapter

1. Command Quick Reference Guide . . . . .	31
1.1 Common (*) Commands . . . . .	31
1.2 EtherNET Subsystem . . . . .	32
1.3 POWER Subsystem . . . . .	32
1.4 STATus Subsystem . . . . .	33
1.5 SYSTem Subsystem . . . . .	33
2. EtherNET Subsystem Command Reference . . . . .	34
2.1 EtherNET:IPADDRESS . . . . .	34
2.2 EtherNET:GATEWAY . . . . .	35
2.3 EtherNET:SUBNET . . . . .	36
2.4 EtherNET:PORT . . . . .	37
3. POWER Subsystem Command Reference . . . . .	38
3.1 POWER:DOWNATTEN . . . . .	38
3.2 POWER:DOWNATTEN1 . . . . .	39
3.3 POWER:DOWNATTEN2 . . . . .	40
3.4 POWER:EXTernal . . . . .	41
3.5 POWER:RAMP:DELTA . . . . .	42
3.6 POWER:RAMP:ENABLE . . . . .	43
3.7 POWER:RAMP:TRIGGER . . . . .	44
3.8 POWER:RAMP:UPATTEN . . . . .	45
3.9 POWER:RF . . . . .	46
3.10 POWER:UPATTEN . . . . .	47
3.11 POWER:UPATTEN1 . . . . .	48
3.12 POWER:UPATTEN2 . . . . .	49
3.13 POWER:UPATTEN3 . . . . .	50
3.14 POWER:UPATTEN4 . . . . .	51



4.	STATus Subsystem Command Reference . . . . .	52
4.1	STATus:OPERation . . . . .	52
4.2	STATus:OPERation:CONDition . . . . .	53
4.3	STATus:OPERation:ENABle . . . . .	54
4.4	STATus:PRESet . . . . .	55
4.5	STATus:QUEStionable . . . . .	56
4.6	STATus:QUEStionable:CONDition . . . . .	57
4.7	STATus:QUEStionable:ENABle . . . . .	58
5.	SYSTem Subsystem Command Reference . . . . .	59
5.1	SYSTem:BOOTSTATE . . . . .	59
5.2	SYSTem:CURRent . . . . .	60
5.3	SYSTem:ERRor . . . . .	61
5.4	SYSTem:FIRMware . . . . .	65
5.5	SYSTem:LOADSTATE . . . . .	66
5.6	SYSTem:READSTATE . . . . .	67
5.7	SYSTem:SAVESTATE . . . . .	68
5.8	SYSTem:SERialNUMber . . . . .	69
5.9	SYSTem:VERSion . . . . .	70
6.	IEEE 488.2 Command Reference . . . . .	71
6.1	Introduction . . . . .	71
6.2	*CLS . . . . .	72
6.3	*ESE <NRf> . . . . .	73
6.4	*ESR? . . . . .	74
6.5	*IDN? . . . . .	75
6.6	*OPC . . . . .	76
6.7	*RCL <NRf> . . . . .	77
6.8	*RST . . . . .	78
6.9	*SAV <NRf> . . . . .	79
6.10	*SDS <NRf> . . . . .	80
6.11	*SRE <NRf> . . . . .	81
6.12	*STB? . . . . .	82
6.13	*TST? . . . . .	83
6.14	*WAI . . . . .	84

## 1. Command Quick Reference Guide

### 1.1 Common (\*) Commands

**Table 5.1:** Common (\*) Commands Summary

Command	Page	Description
*CLS	72	Clears the data structures. The SCPI registers are cleared.
*ESE <NRf>	73	Sets the Standard Event Status Enable Register.
*ESE?	73	Returns the Standard Event Status Enable Register.
*ESR?	74	Returns the contents of the Standard Event Status Register and then clears it.
*IDN?	75	Returns the identification of the device connected to the computer (Host).
*OPC	76	Causes the Single-Channel, Single-Stage Up/Downconverter to set the operation complete bit in the Standard Event Status Register when all pending operations have completed.
*OPC?	76	Returns the operation complete bit in the Standard Event Status Register when all pending operations have completed.
*RCL <NRf>	77	Recalls the settings of the Single-Channel, Single-Stage Up/Downconverter from the specified register (memory location).
*RST	78	Returns the Single-Channel, Single-Stage Up/Downconverter to its initial power up state.
*SAV <NRf>	79	Saves the settings of the Single-Channel, Single-Stage Up/Downconverter to the specified register (memory location).
*SDS <NRf>	80	Saves the default settings of the Single-Channel, Single-Stage Up/Downconverter to the specified register (memory location).
*SRE <NRf>	81	Sets the Service Request Enable register bits.
*SRE?	81	Returns the Service Request Enable register bits.
*STB?	82	Returns the Single-Channel, Single-Stage Up/Downconverter status byte.
*TST?	83	Performs a self-test and returns the result.
*WAI	84	Causes the Single-Channel, Single-Stage Up/Downconverter to wait until either all pending commands are complete, the Device Clear command is received, or the power is cycled before executing any subsequent commands or queries.

## 1.2 EtherNET Subsystem

**Table 5.2:** EtherNET Subsystem Commands Summary

Command	Page	Description
EtherNET:IPADDRESS	34	Sets or Returns the IP Address.
EtherNET:GATEWAY	35	Sets or Returns the Gateway.
EtherNET:SUBNET	36	Sets or Returns the Subnet Mask.
EtherNET:PORT	37	Sets or Returns the Port.

## 1.3 POWER Subsystem

**Table 5.3:** POWER Subsystem Commands Summary

Command	Page	Description
POWER:DOWNATTEN	38	Sets or Returns the total value of receive attenuation.
POWER:DOWNATTEN1	39	Sets or Returns the value of the first receive attenuator.
POWER:DOWNATTEN2	40	Sets or Returns the value of the second receive attenuator.
POWER:EXTERNAL	41	Sets or Returns whether the attenuators are controlled by the external connector or internal software settings.
POWER:RAMP:DELTA	42	Sets or Returns the initial time delta in transmit attenuation ramp mode.
POWER:RAMP:ENABLE	43	Sets or Returns transmit attenuation ramp mode status.
POWER:RAMP:TRIGGER	44	Issues a software trigger in transmit attenuation ramp mode.
POWER:RAMP:UPATTEN	45	Sets or Returns the starting attenuation in transmit ramp mode.
POWER:RF	46	Turns on or off the RF output of the device.
POWER:UPATTEN	47	Sets or Returns the total value of transmit attenuation.
POWER:UPATTEN1	48	Sets or Returns the value of the first transmit attenuator.
POWER:UPATTEN2	49	Sets or Returns the value of the second transmit attenuator.
POWER:UPATTEN3	50	Sets or Returns the value of the third transmit attenuator.
POWER:UPATTEN4	51	Sets or Returns the value of the fourth transmit attenuator.

## 1.4 STATus Subsystem

**Table 5.4:** STATus Subsystem Commands Summary

Command	Page	Description
STATus:OPERation	52	Returns the contents of the status event register.
STATus:OPERation:CONDition	53	Returns the contents of the condition register.
STATus:OPERation:ENABle	54	Sets the enable bit mask for the status event register.
STATus:PRESet	55	Presets the STATus:QUEStionable:ENABle register.
STATus:QUEStionable	56	Returns the contents of the questionable register.
STATus:QUEStionable:CONDition	57	Returns the contents of the questionable condition register.
STATus:QUEStionable:ENABle	58	Sets the enable bit mask for the questionable register.

## 1.5 SYSTem Subsystem

**Table 5.5:** SYSTem Subsystem Commands Summary

Command	Page	Description
SYSTem:BOOTSTATE	59	Specifies a state to boot to at device startup.
SYSTem:CURREnt	60	Returns the current draw of the device.
SYSTem:FIRMWare	65	Returns the current firmware version of the device.
SYSTem:LOADSTATE	66	Loads and sets the parameters from the specified state.
SYSTem:READSTATE	67	Reads the parameters from the stored state without changing the current device setup.
SYSTem:SAVESTATE	68	Saves the current parameters to a specified state number.
SYSTem:SERialNUMBER	69	Returns the serial number of the device.
SYSTem:VERSion	70	Returns the version of SCPI implemented in the Single-Channel, Single-Stage Up/Downconverter.

## 2. EtherNET Subsystem Command Reference

### 2.1 EtherNET:IPADDRESS <ipString>

This command sets the IP Address of the Single-Channel, Single-Stage Up/Downconverter.

#### Syntax

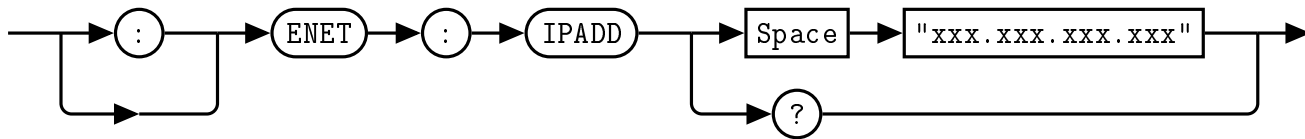

#### Example

:ENET:IPADD "192.168.2.188" *This command sets the IP address to 192.168.2.188*

#### Default Condition

On startup, the IP Address defaults to the previously programmed value. The default IP Address is 192.168.2.188.

#### Query

:ENET:IPADD? *This query returns the system's current IP Address.*

#### Error Message

If the ipString is not in the recognized format, error -102, "Syntax error" occurs.

## 2.2 EtherNET:GATEWAY <ipString>

This command sets the Gateway of the Single-Channel, Single-Stage Up/Downconverter.

### Syntax

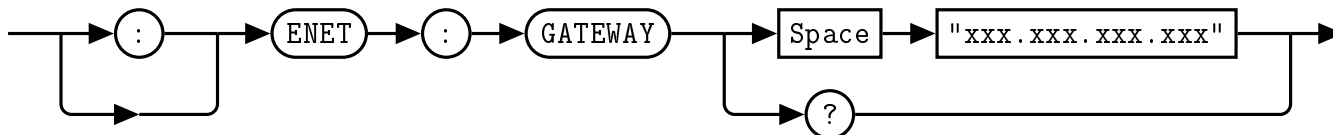

### Example

:ENET:GATEWAY "192.168.2.1" *This command sets the Gateway to 192.168.2.1*

### Default Condition

On startup, the Gateway defaults to the previously programmed value. The default Gateway is 192.168.2.1.

### Query

:ENET:GATEWAY? *This query returns the system's current Gateway.*

### Error Message

If the ipString is not in the recognized format, error -102, "Syntax error" occurs.

### 2.3 EtherNET:SUBNET <ipString>

This command sets the Subnet Mask of the Single-Channel, Single-Stage Up/Downconverter.

#### Syntax

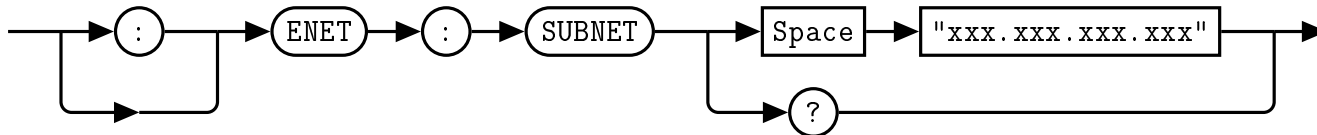

#### Example

:ENET:SUBNET "255.255.255.0" *This command sets the Subnet Mask to 255.255.255.0*

#### Default Condition

On startup, the Subnet Mask defaults to the previously programmed value. The default IP Address is 255.255.255.0.

#### Query

:ENET:SUBNET? *This query returns the system's current Subnet Mask.*

#### Error Message

If the ipString is not in the recognized format, error -102, "Syntax error" occurs.

## 2.4 EtherNET:PORT <numeric value>

This command sets the network port of the Single-Channel, Single-Stage Up/Downconverter.

### Syntax

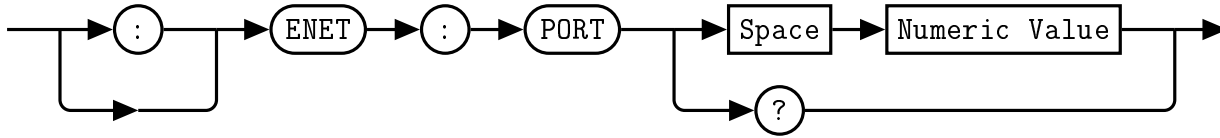

### Example

:ENET:PORT 5025 *This command sets the port number to 5025*

### Default Condition

On startup, the port number defaults to the previously programmed value. The default port number is 5025.

### Query

:ENET:PORT? *This query returns the Single-Channel, Single-Stage Up/Downconverter's current port number.*

### Error Message

If the parameter is not in the recognized format, error -102, "Syntax error" occurs.



### 3. POWER Subsystem Command Reference

#### 3.1 POWER:DOWNATTEN <numeric value>

This command allows the user to set the total attenuation level of the QM1007-9765-1200 downconverter to a specified numeric value. The range of acceptable attenuation values is 0 - 62.5 dB in 0.5 dB steps.

#### Syntax

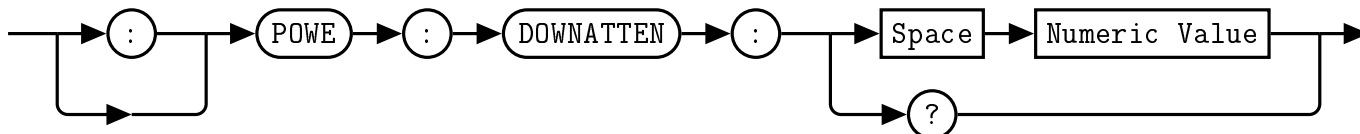

#### Example

:POWE:DOWNATTEN 62.5 *This command sets the downconverter total attenuation to 62.5 dB*

#### Default Condition

On power up, or when a \*RST command is issued, the QM1007-9765-1200 downconverter attenuation level returns to the boot state's setting. The Single-Channel, Single-Stage Up/Downconverter default setting is 0.

#### Query

:POWE:DOWNATTEN? 5 *(The downconverter attenuation level is 5 dB.)*

#### Error Message

If the parameter is not in the recognized format, error -102, "Syntax error" occurs.

If the parameter is less than 0 or greater than 62.5, error -222, "Data out of range" occurs.

### 3.2 POWER:DOWNATTEN1 <numeric value>

This command allows the user to set the attenuation level of the QM1007-9765-1200 downconverter A1 attenuator to a specified numeric value. The range of acceptable attenuation values is 0 - 31 dB in 1 dB steps.

#### Syntax

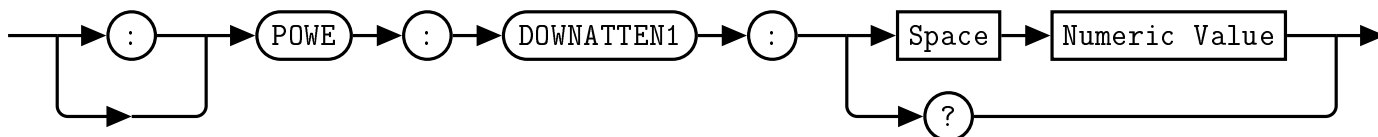

#### Example

:POWE:DOWNATTEN1 31 *This command sets the downconverter A1 attenuator to 31 dB*

#### Default Condition

On power up, or when a \*RST command is issued, the QM1007-9765-1200 downconverter A1 attenuator level returns to the boot state's setting. The Single-Channel, Single-Stage Up/Downconverter default setting is 0.

#### Query

:POWE:DOWNATTEN1? 5 *(The downconverter A1 attenuation level is 5 dB.)*

#### Error Message

If the parameter is not in the recognized format, error -102, "Syntax error" occurs.

If the parameter is less than 0 or greater than 31, error -222, "Data out of range" occurs.

### 3.3 POWER:DOWNATTEN2 <numeric value>

This command allows the user to set the attenuation level of the QM1007-9765-1200 downconverter A2 attenuator to a specified numeric value. The range of acceptable attenuation values is 0 - 31.5 dB in 0.5 dB steps.

#### Syntax

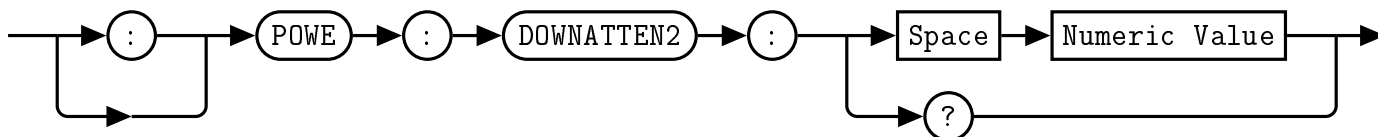

#### Example

:POWE:DOWNATTEN2 31.5 *This command sets the downconverter A2 attenuator to 31.5 dB*

#### Default Condition

On power up, or when a \*RST command is issued, the QM1007-9765-1200 downconverter A2 attenuator level returns to the boot state's setting. The Single-Channel, Single-Stage Up/Downconverter default setting is 0.

#### Query

:POWE:DOWNATTEN2? 5 *(The downconverter A2 attenuation level is 5 dB.)*

#### Error Message

If the parameter is not in the recognized format, error -102, "Syntax error" occurs.

If the parameter is less than 0 or greater than 31.5, error -222, "Data out of range" occurs.

### 3.4 POWER:EXTernal [1|0]

This command allows the user to select between internal attenuation control and external attenuation control through the Single-Channel, Single-Stage Up/Downconverter back connector.

When *0* is specified, internal attenuation control is used by the Single-Channel, Single-Stage Up/Downconverter.

When *1* is specified, external attenuation control is used by the Single-Channel, Single-Stage Up/Downconverter.

#### Syntax

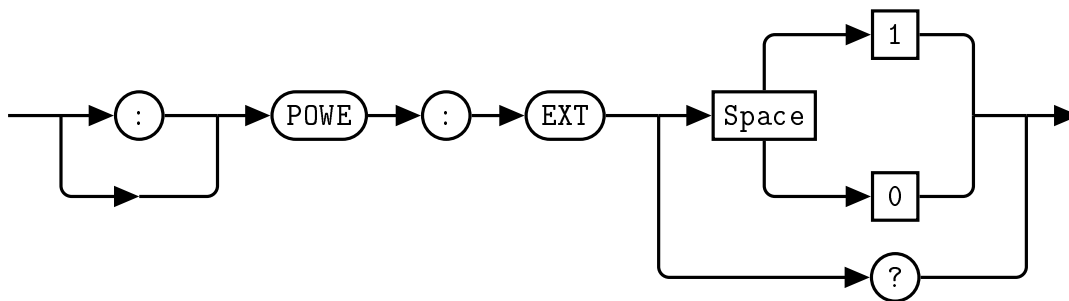

#### Example

:POWER:EXT 0

*This command selects internal attenuation control.*

#### Default Condition

On power up, or when a \*RST command is issued, the Single-Channel, Single-Stage Up/Downconverter returns to the boot state's setting. The Single-Channel, Single-Stage Up/Downconverter default setting is 0.

#### Query

:POWER:EXT? *This query returns a 0 or 1 to indicate the selected Single-Channel, Single-Stage Up/Downconverter attenuation control source*

- 0 is returned if internal attenuation control is selected
- 1 is returned if external attenuation control is selected

#### Error Message

If the parameter is not in the recognized format, error *-102, "Syntax error"* occurs.

If the parameter is not 1 or 0, error *-222, "Data out of range"* occurs.

### 3.5 POWER:RAMP:DELTA <numeric value>

This command allows the user to set the initial time delta of the QM1007-9765-1200 upconverter when in ramp mode. The acceptable input range is 0.35 - 570.4783  $\mu\text{s}$ . Ramp time coefficients are recalculated upon receipt of this command.

#### Syntax

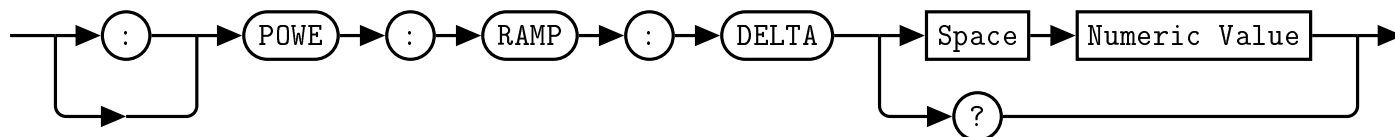

#### Example

:POWER:RAMP:DELTA 1 *This command sets the upconverter ramp initial time delta to 1  $\mu\text{s}$*

#### Default Condition

On power up, or when a \*RST command is issued, the QM1007-9765-1200 upconverter ramp initial time delta returns to the boot state's setting. The Single-Channel, Single-Stage Up/Downconverter default setting is 1.

#### Query

:POWER:RAMP:DELTA? 1.235 *(The upconverter ramp initial time delta is 1.235  $\mu\text{s}$ .)*

#### Error Message

If the parameter is not in the recognized format, error -102, "Syntax error" occurs.

If the parameter is less than 0 or greater than 570.4783, error -222, "Data out of range" occurs.

### 3.6 POWER:RAMP:ENABLE [1|0]

This command allows the user to select between a constant upconverter attenuation level and a decaying power ramp.

When *0* is specified, a constant upconverter attenuation level is used by the Single-Channel, Single-Stage Up/Downconverter.

When *1* is specified, a decaying power ramp is used by the Single-Channel, Single-Stage Up/Downconverter.

#### Syntax

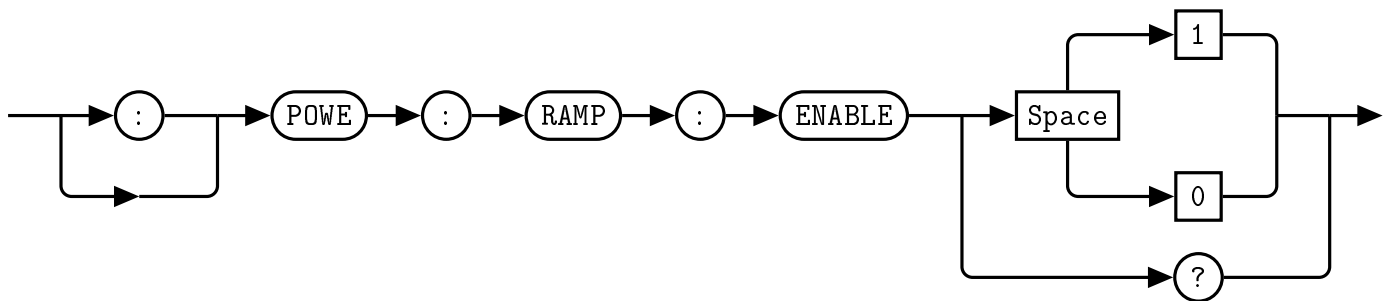

#### Example

`:POWER:RAMP:ENABLE 1` This command selects the upconverter power ramping mode.

#### Default Condition

On power up, or when a *\*RST* command is issued, the Single-Channel, Single-Stage Up/Downconverter returns to the boot state's setting. The Single-Channel, Single-Stage Up/Downconverter default setting is 0.

#### Query

`:POWER:RAMP:ENABLE?` This query returns a 0 or 1 to indicate the selected Single-Channel, Single-Stage Up/Downconverter power ramp mode

- 0 is returned if the upconverter is in constant attenuation mode
- 1 is returned if the upconverter is in power ramp mode

#### Error Message

If the parameter is not in the recognized format, error *-102*, "Syntax error" occurs.

If the parameter is not 1 or 0, error *-222*, "Data out of range" occurs.

### 3.7 POWER:RAMP:TRIGGER

This command issues a software trigger to initiate a decaying power ramp. If external attenuation control is enabled, this trigger is ignored (See *POWER:EXternal*).

#### Syntax

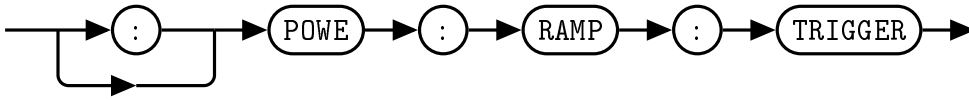

#### Example

:POWER:RAMP:TRIGGER *This command issues a software trigger.*

### 3.8 POWER:RAMP:UPATTEN <numeric value>

This command allows the user to set the starting attenuation level of the QM1007-9765-1200 upconverter when in ramp mode. The range of acceptable attenuation values is 0 - 124.5 dB in 0.5 dB steps. The ramp time coefficients are recalculated upon receipt of this command.

#### Syntax

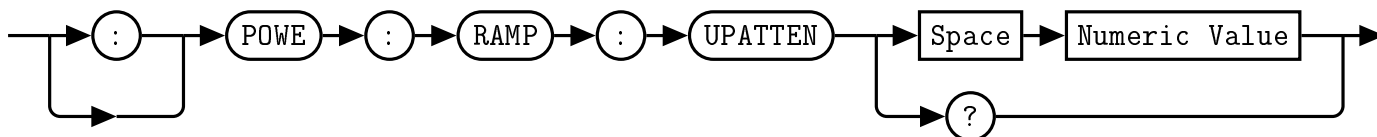

#### Example

:POWE:RAMP:UPATTEN 0 *This command sets the upconverter ramp initial attenuation to 0 dB*

#### Default Condition

On power up, or when a *\*RST* command is issued, the QM1007-9765-1200 upconverter ramp initial attenuation level returns to the boot state's setting. The Single-Channel, Single-Stage Up/Downconverter default setting is 0.

#### Query

:POWE:RAMP:UPATTEN? 0 *(The upconverter ramp initial attenuation level is 0 dB.)*

#### Error Message

If the parameter is not in the recognized format, error -102, "Syntax error" occurs.

If the parameter is less than 0 or greater than 124.5, error -222, "Data out of range" occurs.



### 3.9 POWER:RF [ON|OFF|1|0]

This command allows the user to turn on and off the RF output of the Single-Channel, Single-Stage Up/Downconverter.

When *0* or *OFF* is specified, the RF output is turned off.

When *1* or *ON* is specified, the RF output is turned on.

#### Syntax

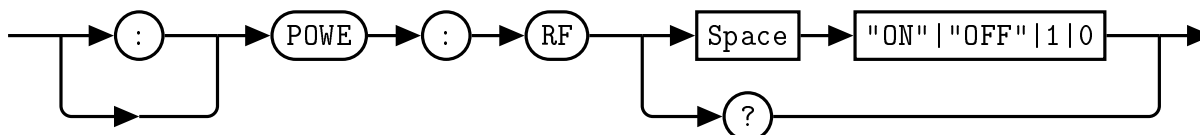

#### Example

:POWE:RF 0 *This command turns off the RF.*

#### Default Condition

On power up, or when a *\*RST* command is issued, the Single-Channel, Single-Stage Up/Downconverter returns to the boot state's setting. The Single-Channel, Single-Stage Up/Downconverter default setting is 0.

#### Query

:POWE:RF? *This query returns a 0 or 1 to indicated the Single-Channel, Single-Stage Up/Downconverter output power state.*

- 0 is returned if the RF output is *OFF*
- 1 is returned if the RF output is *ON*

#### Error Message

If the parameter is not in the recognized format, error -102, "Syntax error" occurs.

### 3.10 POWER:UPATTEN <numeric value>

This command allows the user to set the total attenuation level of the QM1007-9765-1200 upconverter to a specified numeric value. The range of acceptable attenuation values is 0 - 124.5 dB in 0.5 dB steps.

#### Syntax

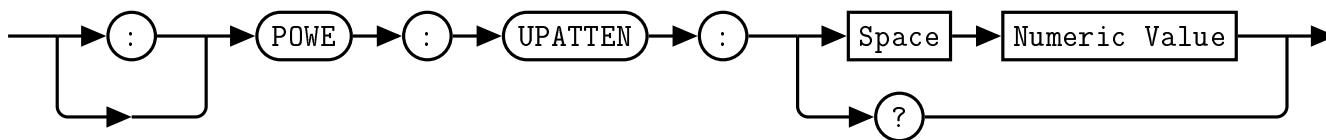

#### Example

:POWE:UPATTEN 124.5 *This command sets the upconverter total attenuation to 124.5 dB*

#### Default Condition

On power up, or when a \*RST command is issued, the QM1007-9765-1200 upconverter attenuation level returns to the boot state's setting. The Single-Channel, Single-Stage Up/Downconverter default setting is 0.

#### Query

:POWE:UPATTEN? 5 *(The upconverter attenuation level is 5 dB.)*

#### Error Message

If the parameter is not in the recognized format, error -102, "Syntax error" occurs.

If the parameter is less than 0 or greater than 124.5, error -222, "Data out of range" occurs.

### 3.11 POWER:UPATTEN1 <numeric value>

This command allows the user to set the attenuation level of the QM1007-9765-1200 upconverter A1 attenuator to a specified numeric value. The range of acceptable attenuation values is 0 - 31.5 dB in 0.5 dB steps.

#### Syntax

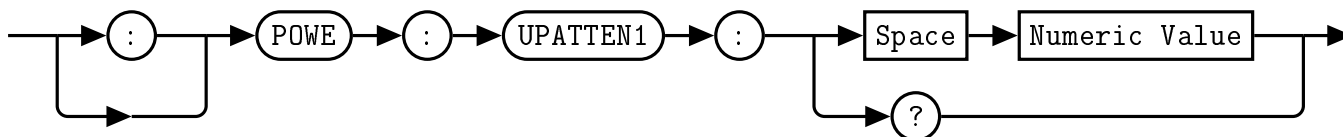

#### Example

:POWE:UPATTEN1 31.5 *This command sets the upconverter A1 attenuator to 31.5 dB*

#### Default Condition

On power up, or when a *\*RST* command is issued, the QM1007-9765-1200 upconverter A1 attenuator level returns to the boot state's setting. The Single-Channel, Single-Stage Up/Downconverter default setting is 0.

#### Query

:POWE:UPATTEN1? 5 *(The upconverter A1 attenuation level is 5 dB.)*

#### Error Message

If the parameter is not in the recognized format, error -102, "Syntax error" occurs.

If the parameter is less than 0 or greater than 31.5, error -222, "Data out of range" occurs.

### 3.12 POWER:UPATTEN2 <numeric value>

This command allows the user to set the attenuation level of the QM1007-9765-1200 upconverter A2 attenuator to a specified numeric value. The range of acceptable attenuation values is 0 - 31 dB in 1 dB steps.

#### Syntax

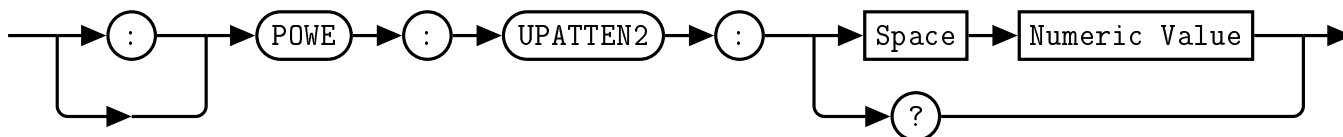

#### Example

:POWE:UPATTEN2 31 *This command sets the upconverter A2 attenuator to 31 dB*

#### Default Condition

On power up, or when a \*RST command is issued, the QM1007-9765-1200 upconverter A2 attenuator level returns to the boot state's setting. The Single-Channel, Single-Stage Up/Downconverter default setting is 0.

#### Query

:POWE:UPATTEN2? 5 *(The upconverter A2 attenuation level is 5 dB.)*

#### Error Message

If the parameter is not in the recognized format, error -102, "Syntax error" occurs.

If the parameter is less than 0 or greater than 31, error -222, "Data out of range" occurs.

### 3.13 POWER:UPATTEN3 <numeric value>

This command allows the user to set the attenuation level of the QM1007-9765-1200 upconverter A3 attenuator to a specified numeric value. The range of acceptable attenuation values is 0 - 31 dB in 1 dB steps.

#### Syntax

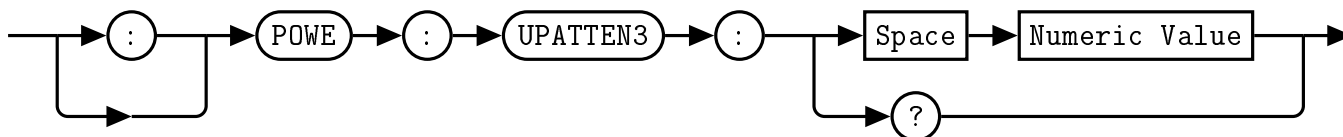

#### Example

:POWE:UPATTEN3 31 *This command sets the upconverter A3 attenuator to 31 dB*

#### Default Condition

On power up, or when a \*RST command is issued, the QM1007-9765-1200 upconverter A3 attenuator level returns to the boot state's setting. The Single-Channel, Single-Stage Up/Downconverter default setting is 0.

#### Query

:POWE:UPATTEN3? 5 *(The upconverter A3 attenuation level is 5 dB.)*

#### Error Message

If the parameter is not in the recognized format, error -102, "Syntax error" occurs.

If the parameter is less than 0 or greater than 31, error -222, "Data out of range" occurs.

### 3.14 POWER:UPATTEN4 <numeric value>

This command allows the user to set the attenuation level of the QM1007-9765-1200 upconverter A4 attenuator to a specified numeric value. The range of acceptable attenuation values is 0 - 31 dB in 1 dB steps.

#### Syntax

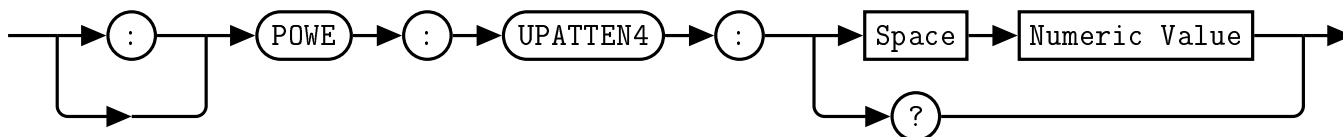

#### Example

:POWE:UPATTEN4 31 *This command sets the upconverter A4 attenuator to 31 dB*

#### Default Condition

On power up, or when a \*RST command is issued, the QM1007-9765-1200 upconverter A4 attenuator level returns to the boot state's setting. The Single-Channel, Single-Stage Up/Downconverter default setting is 0.

#### Query

:POWE:UPATTEN4? 5 *(The upconverter A4 attenuation level is 5 dB.)*

#### Error Message

If the parameter is not in the recognized format, error -102, "Syntax error" occurs.

If the parameter is less than 0 or greater than 31, error -222, "Data out of range" occurs.

## 4. STATus Subsystem Command Reference

### 4.1 STATus:OPERation?

This query returns the contents of the status event register. Reading from this event register clears it.

The use of the :EVENT token is optional.

#### Syntax

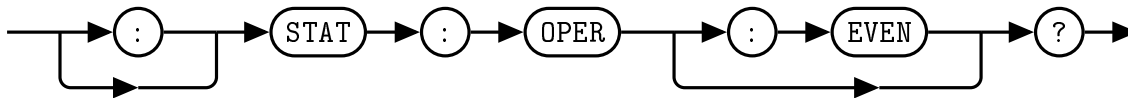

#### Allowed Values

The *NRf* parameter can be any integer in the range of 0 to 32767.

#### Query

:STAT:OPER? *The status event register is queried.*

#### Reset Condition

On reset, the status event register is cleared.

## 4.2 STATus:OPERation:CONDition?

This query returns the contents of the condition register.

### Syntax

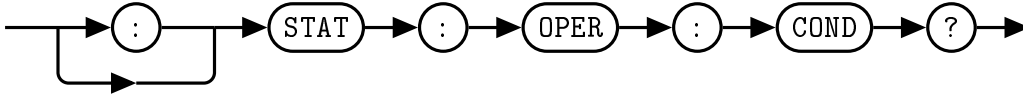

### Allowed Values

The *NRf* parameter can be any integer in the range of 0 to 32767.

### Query

:STAT:OPER:COND? *The condition register is queried.*

### Reset Condition

On reset, the condition register is cleared.



### 4.3 STATus:OPERation:ENABle <NRf>

This command sets the enable mask for the status event register. A bit value of 1 in the mask will allow a positive transition in the associated summary bit of the event register if the event bit transitions to true.

#### Syntax

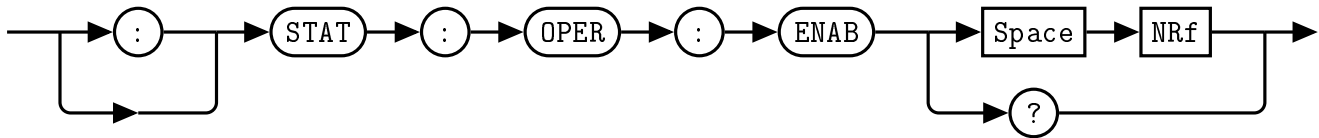

#### Allowed Values

The *NRf* parameter can be any integer in the range of 0 to 32767.

#### Query

:STAT:OPER:ENAB? *The event register enable bit mask is queried.*

#### Reset Condition

On reset, the enable bit mask register is cleared.

#### Error Message

If the parameter is not in the recognized format, error -102, "Syntax error" occurs.

If the parameter is less than 0 or greater than 32767, error -222, "Data out of range" occurs.

#### 4.4 STATus:PRESet

The PRESet command presets the STATus:QUESTionable:ENABLE register to 0. No other registers are affected. \*CLS;\*SRE 0;\*ESE 0 is the recommended command sequence to reset all other status/event registers.

##### Syntax

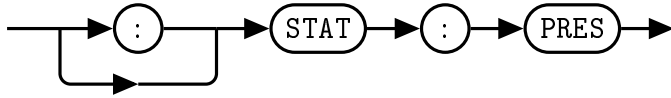

##### Example

:STAT:PRES *The questionable enable register is preset.*

#### 4.5 STATus:QUEStionable?

This query returns the contents of the questionable status register. A value of 1 in the bit indicates the accuracy of the signal is of questionable quality.

The use of the :EVENT token is optional.

##### Syntax

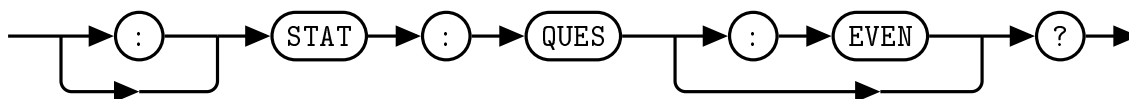

##### Allowed Values

The  $NRf$  parameter can be any integer in the range of 0 to 32767.

##### Query

:STAT:QUES? *The questionable register is queried.*

##### Reset Condition

On reset, the questionable register is cleared.

#### 4.6 STATus:QUEStionable:CONDition?

This query returns the contents of the questionable condition register.

##### Syntax

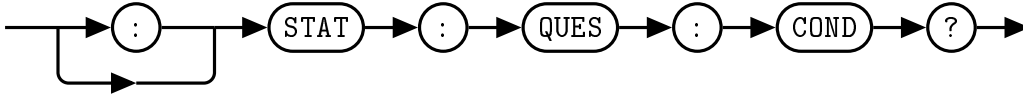

##### Allowed Values

The *NRf* parameter can be any integer in the range of 0 to 32767.

##### Query

:STAT:QUES:COND? *The questionable condition register is queried.*

##### Reset Condition

On reset, the questionable condition register is cleared.

#### 4.7 STATus:QUEStionable:ENABle <NRf>

This command sets the enable mask for the questionable event register. A bit value of 1 in the mask will allow a positive transition in the associated summary bit of the questionable event register if the event bit transitions to true.

##### Syntax

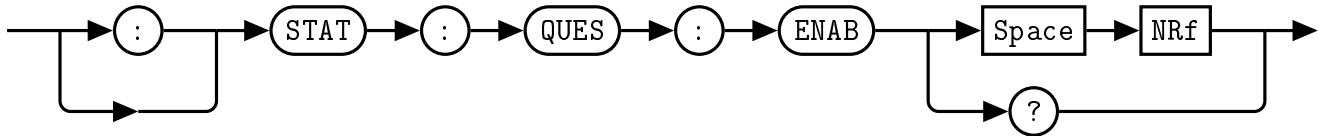

##### Allowed Values

The *NRf* parameter can be any integer in the range of 0 to 32767.

##### Query

:STAT:QUES:ENAB? *The questionable register enable bit mask is queried.*

##### Reset Condition

On reset, the enable bit mask register is cleared.

##### Error Message

If the parameter is not in the recognized format, error -102, "Syntax error" occurs.

If the parameter is less than 0 or greater than 32767, error -222, "Data out of range" occurs.

## 5. SYSTem Subsystem Command Reference

### 5.1 SYSTem:BOOTSTATE [0-5]

This command specifies a previously saved state to be loaded upon device startup. In addition to factory default state 0, there are 5 re-writeable memory locations. Any of these 6 boot states can be selected by choosing an index between 0 and 5. The restored parameters are the *Upconverter A1-A4 attenuation levels*, *Attenuation ramp initial attenuation level*, *Attenuation ramp initial time delta*, *Attenuation ramp enable*, *Downconverter A1-A2 attenuation levels*, *External attenuation control enable*, and *RF power state*. For a detailed description of the parameters saved, see the relevant command descriptions in this manual. When this command is issued, the selected state will be loaded on the next power cycle or by issuing the *\*RST* command.

#### Syntax

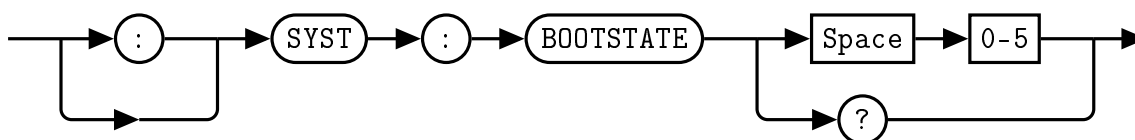

There are 6 memory locations, numbered 0 through 5. Memory location 0 contains the factory default settings, while locations 1-5 are user re-writeable using SYSTem:BOOTSTATE.

#### Example

`:SYST:BOOTSTATE 1` *This command specifies state 1 to be loaded upon device powerup.*

#### Default Condition

The factory default setting for `SYST:BOOTSTATE` is 0.

#### Query

`:SYST:BOOTSTATE?` *This query returns a 0 - 5 to indicate the Single-Channel, Single-Stage Up/Downconverter selected boot state.*

- 0 is returned if the selected boot state is 0

#### Error Message

If the parameter is not in the recognized format, error -102, "Syntax error" occurs.

If the parameter is less than 0 or greater than 5, error -222, "Data out of range" occurs.

## 5.2 SYSTem:CURRent?

This command returns the current reading from the Single-Channel, Single-Stage Up/Downconverter in Amps.

### Syntax

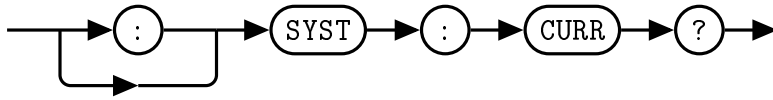

### Query Example

:SYST:CURR? 1.2 *The Single-Channel, Single-Stage Up/Downconverter current draw is 1.2 Amps.*

### 5.3 SYSTem:ERRor[:NEXT]?

This query returns error numbers and messages from the QM1007-9765-1200 error queue. When an error is generated by the QM1007-9765-1200, the error number and corresponding error message are stored in the error queue. Each time the error queue is queried, the first error in the error queue is returned. The errors are read out in the order of first-in first-out. To clear all errors in the error queue, use the \*CLS command.

When the error queue is empty, a query of the error queue will return a 0, "No error" message. The error queue has a maximum capacity of 10 errors.

The use of the :NEXT token is optional.

#### Syntax

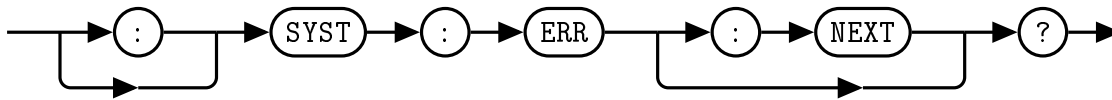

#### Query Example

:SYST:ERR? *Queries the system error.*

**Error queue messages have the following format:**



For example, -102, "Syntax error"

#### Reset Condition

On reset, the error queue is cleared.

#### Error Message List

**Table 5.6:** Error Codes and Messages

-101	Invalid character Invalid character was found in the command string.
-102	Syntax error Invalid syntax was found in the command string.
-103	Invalid separator Invalid separator was found in the command string.
-105	GET not allowed A Group Execute Trigger (GET) is not allowed within a command string.
-108	Parameter not allowed More parameters were received than expected for the command.



-109	Missing parameter Fewer parameters were received than expected for the command.
-112	Program mnemonic too long A command header was received which contained more than the maximum 12 characters allowed.
-113	Undefined header A command was received that is not valid for the Single-Channel, Single-Stage Up/Downconverter.
-121	Invalid character in number An invalid character was found in the number specified for a parameter value.
-123	Exponent too large A numeric parameter was found whose exponent was larger than 32,000.
-124	Too many digits A numeric parameter was found whose mantissa contained more than 255 digits.
-128	Numeric data not allowed A numeric value was received within a command which does not accept a numeric value.
-131	Invalid suffix A unit was incorrectly specified for a numeric parameter.
-134	Suffix too long A unit used contained more than 12 characters.
-138	Suffix not allowed A unit was received following a numeric parameter which does not accept a unit.
-141	Invalid character data An invalid character was received.
-148	Character data not allowed A discrete parameter was received but a character string or numeric parameter was expected.
-151	Invalid string data An invalid string was received.
-158	String data not allowed A character string was received but not allowed for the command.
-161	Invalid block data A block data element was expected but was invalid.
-168	Block data not allowed A legal block data element was encountered but not allowed by the Product.

-178	<p>Expression data not allowed</p> <p>A legal expression data element was encountered but not allowed by the Product.</p>
-200	<p>Execution error</p> <p>Indicates that an execution error has occurred.</p>
-211	<p>Trigger ignored</p> <p>Indicates that a trigger command was received but ignored because the Single-Channel, Single-Stage Up/Downconverter was not in the wait for trigger state.</p>
-213	<p>Trigger ignored</p> <p>Indicates that a trigger command was received but ignored because the Single-Channel, Single-Stage Up/Downconverter was not in the wait for trigger state.</p>
-222	<p>Data out of range</p> <p>A numeric parameter value is outside the valid range for the command.</p>
-224	<p>Illegal parameter value</p> <p>A discrete parameter was received which was not a valid choice for the command.</p>
-230	<p>Data corrupt or stale</p> <p>This occurs when a measurement command is attempted and either a reset has been received or the state of the Single-Channel, Single-Stage Up/Downconverter has changed such that the measurement is no longer valid.</p>
-241	<p>Hardware missing</p> <p>The Single-Channel, Single-Stage Up/Downconverter is unable to execute the command because the hardware does not support that feature.</p>
-310	<p>System error</p> <p>This error indicates a failure with the Single-Channel, Single-Stage Up/Downconverter.</p>
-330	<p>Self-test failed</p> <p>The -330,"Self-test failed" error indicates a problem with the Single-Channel, Single-Stage Up/Downconverter.</p>
-350	<p>Queue overflow</p> <p>The error queue is full and another error has occurred which could not be recorded.</p>
-410	<p>Query INTERRUPTED</p> <p>A command was received which sends data to the output buffer, but the output buffer contained data from a previous command. The output buffer is cleared when power has been off or after a *RST command has been issued.</p>
-420	<p>Query UNTERMINATED</p> <p>The Single-Channel, Single-Stage Up/Downconverter was addressed to talk but a command has not been received which sends data to the output buffer.</p>

-430	Query DEADLOCKED A command was received which generates too much data to fit in the output buffer and the input buffer is also full. Command execution continues but data is lost.
-440	Query UNTERMINATED after indefinite response The *IDN? command must be the last query command within a command string.
+0	No error No errors in the error queue. Device is operating normally.
+110	Invalid Command For Specified Device The issued command is invalid for the specified device.

## 5.4 SYSTem:FIRMware?

This command returns the current PIC and FPGA firmware versions of the Single-Channel, Single-Stage Up/Downconverter.

### Syntax

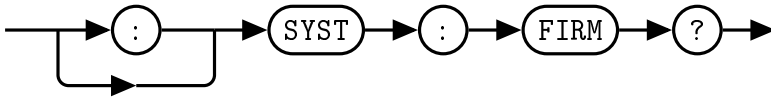

### Query Example

:SYST:FIRM? *This query returns the current firmware versions of the Single-Channel, Single-Stage Up/Downconverter.*

## 5.5 SYSTem:LOADSTATE [0-5]

This command restores a previously saved state from non-volatile memory. In addition to factory default state 0, there are 5 re-writable memory locations, specified by choosing an index between 1 and 5. The restored parameters are the *Upconverter A1-A4 attenuation levels*, *Attenuation ramp initial attenuation level*, *Attenuation ramp initial time delta*, *Attenuation ramp enable*, *Downconverter A1-A2 attenuation levels*, *External attenuation control enable*, and *RF power state*. For a detailed description of the parameters saved, see the relevant command descriptions in this manual. When the SYSTem:LOADSTATE command is called, these parameters will be applied to the device.

### Syntax

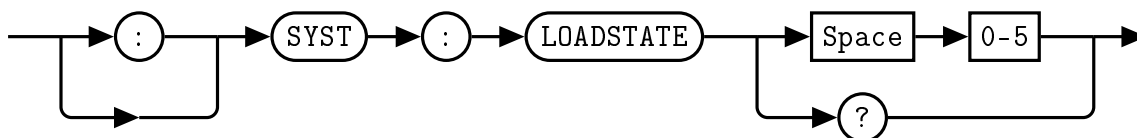

There are 6 memory locations, numbered 0 through 5. Memory location 0 contains the factory default settings, while locations 1-5 are user re-writable using SYSTem:SAVESTATE.

### Example

:SYST:LOADSTATE 4 *This command loads the state 4 parameters from non-volatile memory and applies them to the device.*

### Error Message

If the parameter is not in the recognized format, error -102, "Syntax error" occurs.

If the parameter is less than 0 or greater than 5, error -222, "Data out of range" occurs.

## 5.6 SYSTem:READSTATE? [0-5]

The READSTATE query allows the user to read the parameters of the stored states without changing any internal registers. The query output is a list of parameters for the selected state. The list of state parameters contains comma separated values, without spaces, in the following order: *Upconverter A1-A4 attenuation levels, Attenuation ramp initial attenuation level, Attenuation ramp initial time delta, Attenuation ramp enable, Downconverter A1-A2 attenuation levels, External attenuation control enable, and RF power state*. See the respective command definitions for descriptions of each parameter.

### Syntax

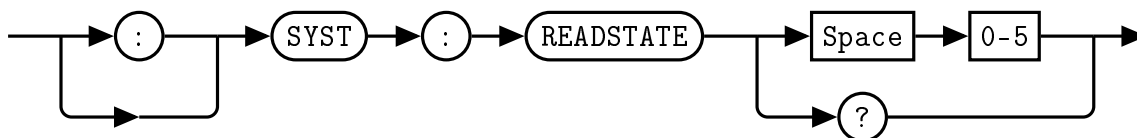

### Query

:SYST:READSTATE? 0 This query requests the parameter values of state 0.

**Response:** 0,0,0,0,0,1,0,0,0,0,0

- 0 = POWER:UPATTEN1 is set to 0 dB (page 48)
- 0 = POWER:UPATTEN2 is set to 0 dB (page 49)
- 0 = POWER:UPATTEN3 is set to 0 dB (page 50)
- 0 = POWER:UPATTEN4 is set to 0 dB (page 51)
- 0 = POWER:RAMP:UPATTEN is set to 0 dB (page 45)
- 1 = POWER:RAMP:DELTA is set to 1  $\mu$ s (page 42)
- 0 = POWER:DOWNATTEN1 is set to 0 dB (page 39)
- 0 = POWER:DOWNATTEN2 is set to 0 dB (page 40)
- 0 = POWER:EXTernal is set to internal (page 41)
- 0 = POWER:RF is set to 0 or OFF. (page 46)

### Error Message

If the parameter is not in the recognized format, error -102, "Syntax error" occurs.

If the parameter is less than 0 or greater than 5, error -222, "Data out of range" occurs.

## 5.7 SYSTem:SAVEm:SAVEm:SAVEm:SAVEm:SAVEm [1-5]

This command saves the current setup to non-volatile memory. There are 5 re-writeable memory locations, specified by choosing an index between 1 and 5. Any of the 5 states can be restored on startup when specified with the SYSTem:BOOTSTATE command. The parameters saved are the *Upconverter A1-A4 attenuation levels, Attenuation ramp initial attenuation level, Attenuation ramp initial time delta, Attenuation ramp enable, Downconverter A1-A2 attenuation levels, External attenuation control enable, and RF power state*. For a detailed description of the parameters saved, see the relevant command descriptions in this manual.

### Syntax

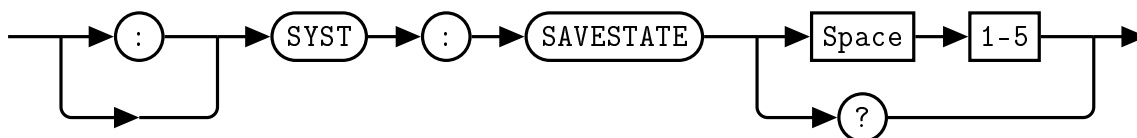

There are 5 memory locations, numbered 1 through 5. Memory location 0 contains the factory default settings and is write-protected.

### Example

:SYST:SAVEm:SAVEm:SAVEm:SAVEm 3 *This command saves the current state to memory location 3*

### Error Message

If the parameter is not in the recognized format, error -102, "Syntax error" occurs.

If the parameter is less than 1 or greater than 5, error -222, "Data out of range" occurs.

## 5.8 SYSTem:SERialNUMber?

This query returns the serial number of the device.

### Syntax

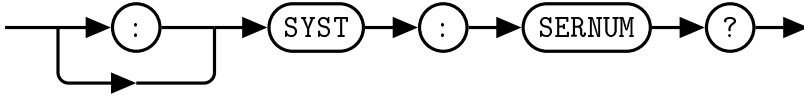

### Query Example

:SYST:SERNUM? *This query returns the serial number of the device.*





## 6. IEEE 488.2 Command Reference

### 6.1 Introduction

This chapter contains information on the IEEE-488.2 Common Commands that the Single-Channel, Single-Stage Up/Downconverter supports.

The IEEE-488.2 Common Command descriptions are listed below.

**Table 5.7:** IEEE 488.2 Common commands

<i>*CLS</i>	Clear Status	Page 72
<i>*ESE</i> and <i>*ESE?</i>	Event Status Enable	Page 73
<i>*ESR?</i>	Event Status Register	Page 74
<i>*IDN?</i>	Identify	Page 75
<i>*OPC</i> and <i>*OPC?</i>	Operation Complete	Page 76
<i>*RCL</i>	Recall	Page 77
<i>*RST</i>	Reset	Page 78
<i>*SAV</i>	Save	Page 79
<i>*SDS</i>	Save Default Settings	Page 80
<i>*SRE</i> and <i>*SRE?</i>	Service Request Enable	Page 81
<i>*STB?</i>	Status Byte	Page 82
<i>*TST?</i>	Test	Page 83
<i>*WAI</i>	Wait	Page 84

## 6.2 \*CLS

The \*CLS (CLear Status) command clears the data structures. The SCPI registers are all cleared.

### Syntax

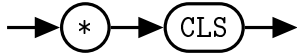

### 6.3 \*ESE <NRf>

The \*ESE (Event Status Enable) command sets the Standard Event Status Enable Register. This register contains a mask value for the bits to be enabled in the Standard Event Status Register. A 1 in the enable register enables the corresponding bit in the Status Register, a 0 disables the corresponding bit in the Status Register. The parameter value when expressed in base 2, represents the bit values of the Standard Event Status Enable Register. Table 5.8 shows the contents of this register.

**Table 5.8: \*ESE bit mapping**

Bit	Base 2	Meaning
0	1	Operation Complete
1	2	Request Control (not used)
2	4	Query Error
3	8	Device Dependent Error
4	16	Execution Error
5	32	Command Error
6	64	Not Used
7	128	Power On

#### Syntax

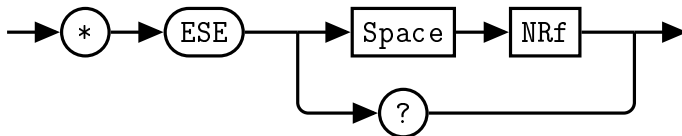

#### Allowed Values

The *NRf* parameter can be any integer in the range of 0 to 255.

#### Query

\*ESE? *This query returns the contents of the Standard Event Status Enable Register.*

#### Error Message

If the parameter is not in the recognized format, error -102, "Syntax error" occurs.

If the parameter is less than 0 or greater than 255, error -222, "Data out of range" occurs.

## 6.4 \*ESR?

The *\*ESR?* query returns the contents of the Standard Event Status Register then clears it. The returned value is in the range of 0 to 255. Table 5.9 shows the contents of this register.

**Table 5.9:** \*ESR? mapping

Bit	Base 2	Meaning
0	1	Operation Complete
1	2	Not Used
2	4	Query Error
3	8	Device Dependent Error
4	16	Execution Error
5	32	Command Error
6	64	Not Used
7	128	Power On

### Syntax



## 6.5 \*IDN?

The *\*IDN?* query allows the connected device to identify itself. The string returned is:

*Quonset Microwave,<Product Number>,<Serial Number>,<Firmware>*

where:

- *<Product Number>* identifies the product number of the host
- *<Serial Number>* uniquely identifies the host
- *<Firmware>* returns the firmware of the host

### Syntax



## 6.6 \*OPC

The *\*OPC* (Operation Complete) command causes the QM1007-9765-1200 Single-Channel, Single-Stage Up/Downconverter to set the operation complete bit in the Standard Event Status Register when all pending device operations have been completed.

**Table 5.10:** \*OPC mapping

Bit	Base 2	Meaning
0	1	Operation Complete
1	2	Not Used
2	4	Query Error
3	8	Device Dependent Error
4	16	Execution Error
5	32	Command Error
6	64	Not Used
7	128	Power On

### Syntax

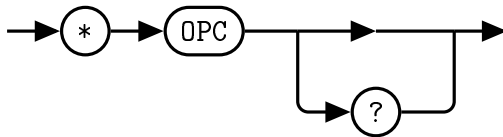

### Query

*\*OPC?* This query places a 1 in the output queue when all device operations have been completed.

## 6.7 \*RCL <NRf>

The \*RCL (ReCaLI) command restores a previously saved state from non-volatile memory. In addition to factory default state 0, there are 5 re-writable memory locations, specified by choosing an index between 1 and 5. The restored parameters are the *Upconverter A1-A4 attenuation levels*, *Attenuation ramp initial attenuation level*, *Attenuation ramp initial time delta*, *Attenuation ramp enable*, *Downconverter A1-A2 attenuation levels*, *External attenuation control enable*, and *RF power state*. For a detailed description of the parameters saved, see the relevant command descriptions in this manual. When the \*RCL command is called, these parameters will be applied to the device.

### Syntax

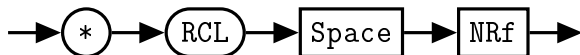

### Allowed Values

The *NRf* parameter can be any integer in the range of 0 to 5.

### Error Message

If the parameter is not in the recognized format, error -102, "Syntax error" occurs.

If the parameter is less than 0 or greater than 5, error -222, "Data out of range" occurs.



## 6.8 \*RST

The *\*RST* (ReSeT) command returns the QM1007-9765-1200 Single-Channel, Single-Stage Up/Downconverter to its initial power-up state.

### Syntax

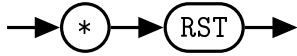

## 6.9 \*SAV <NRf>

The \*SAV (SAVe) command saves the current setup to non-volatile memory. There are 5 re-writeable memory locations, specified by choosing an index between 1 and 5. Any of the 5 states can be restored on startup when specified with the SYSTem:BOOTSTATE command. The parameters saved are the *Up-converter A1-A4 attenuation levels, Attenuation ramp initial attenuation level, Attenuation ramp initial time delta, Attenuation ramp enable, Downconverter A1-A2 attenuation levels, External attenuation control enable, and RF power state*. For a detailed description of the parameters saved, see the relevant command descriptions in this manual.

### Syntax

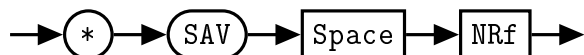

### Allowed Values

The *NRf* parameter can be any integer in the range of 1 to 5.

### Error Message

If the parameter is not in the recognized format, error -102, "Syntax error" occurs.

If the parameter is less than 1 or greater than 5, error -222, "Data out of range" occurs.

## 6.10 \*SDS <NRf>

The \*SDS (Save Default device Settings) command restores the specified state of the QM1007-9765-1200 Single-Channel, Single-Stage Up/Downconverter to the default state settings. There are 5 rewriteable memory locations, specified by choosing an index between 1 and 5. The parameters restored are the *Upconverter A1-A4 attenuation levels*, *Attenuation ramp initial attenuation level*, *Attenuation ramp initial time delta*, *Attenuation ramp enable*, *Downconverter A1-A2 attenuation levels*, *External attenuation control enable*, and *RF power state*. For a detailed description of the parameters saved, see the relevant command descriptions in this manual. Issuing this command does not change the current settings.

### Syntax

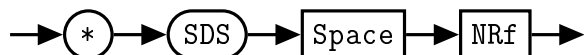

### Allowed Values

The *NRf* parameter can be any integer in the range of 1 to 5.

### Error Message

If the parameter is not in the recognized format, error -102, "Syntax error" occurs.

If the parameter is less than 1 or greater than 5, error -222, "Data out of range" occurs.

## 6.11 \*SRE <NRf>

The \*SRE command sets the Service Request Enable register bits. This register contains a mask value for the bits to be enabled in the Status Byte Register. A 1 in the enable register enables the corresponding bit in the Status Register, a 0 disables the corresponding bit in the Status Register. The parameter value when expressed in base 2, represents bits 0 to 5 and bit 7 of the Service Request Enable Register. Bit 6 is not used and is always 0. Table 5.11 shows the contents of this register.

**Table 5.11: \*SRE bit mapping**

Bit	Base 2	Meaning
0	1	Not used
1	2	Not Used (not used)
2	4	Device Dependent
3	8	Questionable Status Summary
4	16	Message Available
5	32	Event Status Bit
6	64	Not Used
7	128	Operation Status Summary

### Syntax

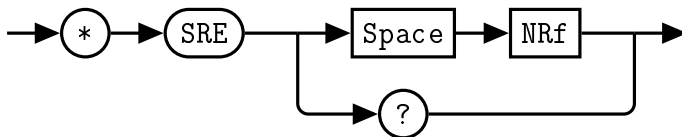

### Allowed Values

The *NRf* parameter can be any integer in the range of 0 to 255.

### Query

\*SRE? *This query returns the contents of bits 0 to 5 and bit 7 of the Service Request Enable Register. Bit 6 is always 0.*

### Error Message

If the parameter is not in the recognized format, error -102, "Syntax error" occurs.

If the parameter is less than 0 or greater than 255, error -222, "Data out of range" occurs.

## 6.12 \*STB?

The *\*STB?* (S**T**atus **B**yte) query returns bit 0 to 5 and bit 7 of the QM1007-9765-1200 Single-Channel, Single-Stage Up/Downconverter status byte and returns the Master Summary Status (MSS) as bit 6. The MSS is inclusive OR of the bitwise combination (excluding bit 6) of the Status Byte and the Service Request Enable registers. The format of the return is an integer between 0 and 255. Table 5.12 shows the contents of this register.

**Table 5.12:** \*STB? mapping

Bit	Base 2	Meaning
0	1	Not used
1	2	Device Dependent 0 - No device status condition has occurred 1 - A device status condition has occurred
2	4	Error/Event Queue 0 = Queue empty 1 = Queue not empty
3	8	Questionable Status Summary 0 - No <b>Q</b> UESTionable status conditions have occurred 1 - A <b>Q</b> UESTionable status condition has occurred
4	16	Message Available 0 - no output messages are ready 1 - an output message is ready
5	32	Event Status Bit 0 - no event status has occurred 1 - an event status condition has occurred
6	64	Master Summary Status 0 - Single-Channel, Single-Stage Up/Downconverter not requesting service 1 - there is at least one reason for requesting service
7	128	Operation Status Summary 0 = No <b>O</b> PERation status conditions have occurred 1 = An <b>O</b> PERation status condition has occurred

### Syntax



### 6.13 \*TST?

The *\*TST?* query causes the QM1007-9765-1200 Single-Channel, Single-Stage Up/Downconverter to perform a self-test. The result of the self-test is placed in the output queue.

- 0 is returned if the test passes

#### Syntax



## 6.14 \*WAI

The \*WAI (WAI) command causes the QM1007-9765-1200 Single-Channel, Single-Stage Up/Downconverter to wait until either:

- All pending operations are complete
- The *Device Clear* command is received
- Power is cycled

before executing any subsequent commands or queries.

### Syntax

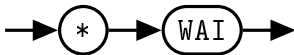

# Index

- Automatic Attenuation Ramp, 5
- Control Commands, 29
  - EtherNET:GATEWAY, 35
  - EtherNET:IPADDRESS, 34
  - EtherNET:PORT, 37
  - EtherNET:SUBNET, 36
  - POWER:DOWNATTEN, 38
  - POWER:DOWNATTEN1, 39
  - POWER:DOWNATTEN2, 40
  - POWER:EXTERNAL, 41
  - POWER:RAMP:DELTA, 42
  - POWER:RAMP:ENABLE, 43
  - POWER:RAMP:TRIGGER, 44
  - POWER:RAMP:UPATTEN, 45
  - POWER:RF, 46
  - POWER:UPATTEN, 47
  - POWER:UPATTEN1, 48
  - POWER:UPATTEN2, 49
  - POWER:UPATTEN3, 50
  - POWER:UPATTEN4, 51
  - STATUS:OPERation, 52
  - STATUS:OPERation:CONDition, 53
  - STATUS:OPERation:ENABLE, 54
  - STATUS:OPERation:QUESTionable, 57
  - STATUS:PRESet, 55
  - STATUS:QUESTionable, 56
  - STATUS:QUESTionable:ENABLE, 58
  - SYSTEM:BOOTSTATE, 59
  - SYSTEM:CURRENT, 60
  - SYSTEM:ERROR, 61
  - SYSTEM:FIRMWARE, 65
  - SYSTEM:LOADSTATE, 66
  - SYSTEM:READSTATE, 67
  - SYSTEM:SAVESTATE, 68
  - SYSTEM:SERIALNUMBER, 69
  - SYSTEM:VERSION, 70
- Default Units, 22
- EtherNET Subsystem Command Reference
  - EtherNET:GATEWAY, 35
  - EtherNET:IPADDRESS, 34
  - EtherNET:PORT, 37
  - EtherNET:SUBNET, 36
- External Control, 7
  - External Attenuation Control, 8
- Firmware Updates, 10
  - FPGA Firmware Updates, 12
  - FTP Location, 11
  - Introduction, 11
  - PIC Firmware Updates, 18
- General Description, 3
- General Safety Information, iii
- IEEE 488.2 Command Reference, 71
  - \*CLS, 72
  - \*ESE, 73
  - \*ESR?, 74
  - \*IDN?, 75
  - \*OPC, 76
  - \*RCL, 77
  - \*RST, 78
  - \*SAV, 79
  - \*SDS, 80
  - \*SRE, 81
  - \*STB?, 82
  - \*TST?, 83
  - \*WAI, 84
- Input/Output Specifications, 3
- Notices, i
- Overview, 2
- POWER Subsystem Command Reference
  - POWER:DOWNATTEN, 38
  - POWER:DOWNATTEN1, 39
  - POWER:DOWNATTEN2, 40
  - POWER:EXTERNAL, 41
  - POWER:RAMP:DELTA, 42



- POWER:RAMP:ENABLE, 43
- POWER:RAMP:TRIGGER, 44
- POWER:RAMP:UPATTEN, 45
- POWER:RF, 46
- POWER:UPATTEN, 47
- POWER:UPATTEN1, 48
- POWER:UPATTEN2, 49
- POWER:UPATTEN3, 50
- POWER:UPATTEN4, 51
- Product Safety, ii
- Remote Operation, 19
  - Introduction, 21
    - Command Syntax, 21
    - Compliance Information, 25
    - Default Units, 22
    - Diagram Syntax Conventions, 21
    - Input Message Terminators, 25
    - SCPI Data Types, 22
    - Status Reporting, 22
    - USB, 21
  - VISA Descriptors and Configuration, 27
    - TCPIP, 28
    - USB, 27
- STATus Subsystem Command Reference
  - STATus:OPERation, 52
  - STATus:OPERation:CONDition, 53
  - STATus:OPERation:ENABle, 54
  - STATus:OPERation:QUEStionable, 57
  - STATus:PRESet, 55
  - STATus:QUEStionable, 56
  - STATus:QUEStionable:ENABle, 58
- System Block Diagram, 4
- SYSTem Subsystem Command Reference
  - SYSTem:BOOTSTATE, 59
  - SYSTem:CURRent, 60
  - SYSTem:ERRor, 61
  - SYSTem:FIRMWare, 65
  - SYSTem:LOADSTATE, 66
  - SYSTem:READSTATE, 67
  - SYSTem:SAVESTATE, 68
  - SYSTem:SERialNUMber, 69
  - SYSTem:VERSion, 70



**Quonset Microwave**  
[www.quonsetmicrowave.com](http://www.quonsetmicrowave.com)



1007-014-21

Revision 0.1.0, April 2019