



Quonset Microwave
www.quonsetmicrowave.com

QM2010
USB Stick Synthesizer
Generation II

User Manual

Revision 4.0.0, August 2016

Notices

© Quonset Microwave 2016

No part of this manual may be reproduced in any form or by any means (including electronic storage and retrieval or translation into a foreign language) without prior permission and written consent from Quonset Microwave as governed by United States and international copyright laws.

Manual Part Number

2010-008-21

Edition

Revision 4.0.0, August 2016

Printed in the USA

Quonset Microwave
315 Commerce Park Road
Unit 3
North Kingstown, RI 02852 USA

Warranty

The material contained in this document is provided "as is," and is subject to be changed, without notice, in future editions. Further, to the maximum extent permitted by applicable law, Quonset Microwave disclaims all warranties, either expressed or implied, with regard to this manual and any information contained herein, including but not limited to the implied warranties of merchantability and fitness for a particular purpose. Quonset Microwave shall not be liable for errors or incidental or consequential damages in connection with the furnishing, use, or performance of this document or of any information contained herein. Should Quonset Microwave and the user have a separate written agreement with warranty terms covering the material in this document that conflict with these terms, the warranty terms in the separate agreement shall control.

Technology Licenses

The hardware and/or software described in this document are furnished under a license and may be used or copied only in accordance with the terms of such license.

Restricted Rights Legend

U.S. Government Restricted Rights. Software and technical data rights granted to the federal government include only those rights customarily provided to end user customers. Quonset Microwave provides this customary commercial license in Software and technical data pursuant to FAR 12.211 (Technical Data) and 12.212 (Computer Software) and, for the Department of Defense, DFARS 252.227-7015 (Technical Data - Commercial Items) and DFARS 227.7202-3 (Rights in Commercial Computer Software or Com-

puter Software Documentation).

Safety Notices

CAUTION

A **CAUTION** notice denotes a hazard. It calls attention to an operating procedure, practice, or the like that, if not correctly performed or adhered to, could result in damage to the product or loss of data. Do not proceed beyond a **CAUTION** notice until the indicated conditions are fully understood and met.

WARNING

A **WARNING** notice denotes a hazard. It calls attention to an operating procedure, practice, or the like that, if not correctly performed or adhered to, could result in personal injury or death. Do not proceed beyond a **WARNING** notice until the indicated conditions are fully understood and met.

Restricted Rights Legend

The Software and Documentation have been developed entirely at private expense. They are delivered and licensed as "commercial computer software" as defined in DFARS 252.227-7013 (Oct 1988), DFARS 252.211-7015 (May 1991), or DFARS 252.227-7014 (Jun 1995), as a "commercial item" as defined in FAR 2.101(a) or as "restricted computer software" as defined in FAR 25.227-19 (Jun 1987) (or any equivalent agency regulation or contract clause), whichever is applicable. The End User has only those rights provided for such Software and Documentation by the applicable FAR or DFARS clause or the Quonset Microwave standard software agreement for the product involved.

General Warranty

The material contained in this document is provided "as is," and is subjected to being changed, without notice, in future editions. Further, to the maximum extent permitted by applicable law, Quonset Microwave disclaims all warranties, either expressed or implied with regard to this manual and any information contained herein, including but not limited to the implied warranties of merchantability and fitness for a particular purpose. Quonset Microwave shall not be liable for errors or for incidental or consequential damages in connection with the furnishing, use, or performance of this document or any information contained herein. Should Quonset Microwave and the user have a separate written agreement with warranty terms covering the material in this document that conflict with these terms, the warranty terms in the separate agreement shall control. Duration and conditions of warranty for this product may be superseded when the product is integrated into (becomes part of) other Quonset Microwave products. During the warranty period, Quonset Microwave will, at its option, either repair or replace products which prove to be defective. The warranty period begins on the date of delivery or on the date of installation if installed by Quonset Microwave.

Product Safety

The following general safety precautions must be observed during all phases of operation of this device. Failure to comply with these precautions or with specific warnings elsewhere in this manual violates safety standards of design, manufacture, and intended use of this device. Quonset Microwave assumes no liability for the customer's failure to comply with these requirements.

Safety Notices

CAUTION

A **CAUTION** notice denotes a hazard. It calls attention to an operating procedure, practice, or the like that, if not correctly performed or adhered to, could result in damage to the product or loss of data. Do not proceed beyond a **CAUTION** notice until the indicated conditions are fully understood and met.

WARNING

A **WARNING** notice denotes a hazard. It calls attention to an operating procedure, practice, or the likes that, if not correctly performed or adhered to, could result in personal injury or death. Do not proceed beyond a **WARNING** notice until the indicated conditions are fully understood and met.

Personal Safety Considerations

This is a Safety Class I product (provided with a protective earthing ground incorporated in the power cord). The mains plug shall only be inserted in a socket outlet provided with a protective earth contact. Any interruption of the protective conductor, inside or outside the product, is likely to make the product dangerous. Intentional interruption is prohibited. If this product is not used as specified, the protection provided by the equipment could be impaired. This product must be used in a normal condition (in which all means of protection are intact) only.

No operator serviceable parts inside. Refer servicing to qualified personnel. To prevent electrical shock, do not remove covers. For continued protection against fire hazard, replace the line fuse(s) only with fuses of the same type and rating (for example, normal blow, time delay, etc.). The use of other fuses or material is prohibited.

General Safety Information

The following general safety precautions must be observed during all phases of operation of this product. Failure to comply with these precautions or with specific warnings elsewhere in this manual or any manual associated with this product violates safety standards of design, manufacture, and intended use of the product. Quonset Microwave assumes no liability for the customer's failure to comply with these requirements.

WARNING

BEFORE APPLYING POWER TO THIS PRODUCT OR MAKING ANY CONNECTIONS TO THIS PRODUCT ensure that all instruments are connected to the protective (earth) ground. Any interruption of the protective earth grounding will cause a potential shock hazard that could result in personal injury or death.

CAUTION

- Use this device with the cables provided.
 - Do not attempt to service this device. This device should be returned to Quonset Microwave for any service or repairs.
 - Do not open the device.
-

User Environment

This instrument is designed for *indoor* use only.

Markings

The following markings may appear on the equipment or in any related documentation.



This marking indicates that a device, or part of a device, may be susceptible to electrostatic discharges (ESD) which can result in damage to the product. Observed ESD precautions given on the product, or in its user documentation, when handling equipment bearing this mark.



This marking indicates that the device complies with applicable sections of part 15 of the FCC rules.



This marking indicates that the device conforms with applicable EC directives.



This marking indicates that the device is equipped with Bluetooth.



This marking indicates that the device is a dual-mode device equipped with both standard and Low Energy Bluetooth.



This marking indicates that the device complies with the Virtual Instrument Software Architecture (VISA) specification.



This marking indicates that the device complies with the Standard Commands for Programmable Instrumentation (SCPI) specification.



This marking indicates that the device complies with the USB Test & Measurement Class (USB TMC) and the USB 488 subclass specifications.



This marking indicates that the device complies with the VME eXtensions for Instrumentation (VXI) specification.



This marking indicates that the device complies with the LAN eXtensions for Instrumentation (LXI) specification.



This marking indicates that the device communicates over the RS232 Serial Bus.



This marking indicates that the device communicates over the Universal Serial Bus (USB).



This marking indicates that the device communicates over Ethernet.



This marking indicates that the device is USB Low Speed and Full Speed certified.



This marking indicates that the device is USB On The Go (OTG) Low Speed and Full Speed certified.



This marking indicates that the device is USB High Speed certified.



This marking indicates that the device is USB On The Go (OTG) High Speed certified.

Revision Control

Revision	Description of Changes	Date
1.0.0	Initial Creation	08/18/2011
2.0.0	Added content for firmware updates	06/12/2012
2.0.1	Minor modifications	03/15/2013
2.0.2	Updated Descriptions and Commands	05/13/2013
2.0.3	Fixed Typo	10/30/2013
2.1.0	Updated Descriptions and Commands	06/01/2016
2.1.1	Updated Descriptions and Commands	06/03/2016
3.0.0	Added SAVESTATE, LOADSTATE, BOOTSTATE, READSTATE Commands	08/01/2016
4.0.0	Updated to reflect v4 firmware changes	08/01/2016

Contents

Notices	i
Manual Part Number	i
Edition	i
Warranty	i
Technology Licenses	i
Restricted Rights Legend	i
Safety Notices	ii
Restricted Rights Legend	iii
General Warranty	iii
Product Safety	iii
Safety Notices	iii
Personal Safety Considerations	iv
General Safety Information	iv
User Environment	iv
Markings	v
Revision Control	vii
1 Product Overview	2
1. QM2010 USB Stick Synthesizer Overview	3
2. Part Number	3
2 Remote Operation	4
1. Introduction	6
1.1 USB Configuration	6
1.2 Command Syntax	6
1.2.1 Mnemonic Forms	6
1.2.2 Using a Semicolon(;)	6
1.2.3 Using Whitespace	6
1.2.4 Using "?" Commands	6
1.2.5 Using "*" Commands	6
1.3 Diagram Syntax Conventions	6
1.4 Default Units	7
1.5 Status Reporting	7
1.6 SCPI Data Types	7
1.6.1 <boolean> Definition	7
1.6.2 <character_data> Definition	8
1.6.3 <NAN> Definition	8
1.6.4 <non-decimal numeric> Definition	8
1.6.5 <NRf> Definition	8
1.6.6 <NR1> Definition	8

1.6.7	<NR2> Definition	8
1.6.8	<NR3> Definition	9
1.6.9	<numeric_value> Definition	9
1.6.10	<string> Definition	9
1.7	Input Message Terminators	10
1.8	Compliance Information	10
1.8.1	IEEE-488.2 Compliance	10
1.8.2	SCPI Compliance	10
1.8.3	USBTMC Compliance	11
1.8.4	VISA Compliance	11
3	Command Quick Reference Guide	12
1.	Common (*) Commands	13
2.	FREQuency Subsystem	14
3.	POWEr Subsystem	14
4.	SYSTem Subsystem	14
4	FREQuency Subsystem	16
1.	FREQuency:LOCK	17
2.	FREQuency:PLLMode	18
3.	FREQuency:REFerence:DIVider	20
4.	FREQuency:REFerence:EXTernal	21
5.	FREQuency:REFerence:FREQuency	22
6.	FREQuency:RETreiveACTual	23
7.	FREQuency:SET	24
5	POWEr Subsystem	25
1.	POWEr:RF	26
2.	POWEr:SET	27
6	SYSTem Subsystem	28
1.	SYSTem:ERRor	29
2.	SYSTem:FIRMware	33
3.	SYSTem:SERialNUMBER	34
4.	SYSTem:STATus	35
5.	SYSTem:TEMPerature	36
6.	SYSTem:VERSion	37
7.	SYSTem:SAVESTATE	38
8.	SYSTem:LOADSTATE	39
9.	SYSTem:BOOTSTATE	40
10.	SYSTem:READSTATE	41
7	IEEE 488.2 Command Reference	42
1.	SCPI Compliance Information	43
2.	*CLS	44
3.	*ESE <NRf>	45
4.	*ESR?	46

5. *IDN?	47
6. *OPC	48
7. *OPT?	49
8. *RCL <NRf>	50
9. *RST	51
10. *SAV <NRf>	52
11. *SRE <NRf>	53
12. *STB?	54
13. *TRG	56
14. *TST?	57
15. *WAI	58
16. USBTMC/USB488 Universal Commands	59
Index	59

List of Tables

2.2	Default Units	7
3.1	Common (*) Commands Summary	13
3.2	FREQUency subsystem Commands Summary	14
3.3	POWER subsystem Commands Summary	14
3.4	SYSTem subsystem Commands Summary	14
4.1	Comparison between Integer and Fractional PLL modes	18
6.1	Error Codes and Messages	29
6.2	Status Codes and Messages	35
7.1	IEEE 488.2 Common commands	43
7.2	*ESE bit mapping	45
7.3	*ESR? mapping	46
7.4	*OPC mapping	48
7.5	*SRE bit mapping	53
7.6	*STB? mapping	54



1 Product Overview

In This Chapter

1. QM2010 USB Stick Synthesizer Overview	3
2. Part Number	3

1. QM2010 USB Stick Synthesizer Overview

The QM2010 USB Stick Synthesizer product line is a low-cost, wideband PLL based line of frequency synthesizers ideally suited for bench top test and measurement as well as low-cost small form-factor radar and communications systems. The QM2010 is USB bus powered so it must be connected to a USB port on the computer or through powered USB hub for operation. The output power of the QM2010 is user adjustable in power steps dependent on the model number. The QM2010 features an internal reference for independent operation. The QM2010 may be operated off an externally applied reference signal between 10 MHz and 100 MHz through the MMCX connector on the side of the QM2010, allowing the QM2010 to be synchronized with other test equipment.

The QM2010 includes three indicator LEDs on the side of the case, a blue LED which when lit indicates that the QM2010 has been enumerated by the computer, the reference selector LED which indicates use of an external reference when lit and an internal reference when off, and the *Lock* LED. The *Lock* LED indicates the lock status of the QM2010. When green, the QM2010 is locked and when red the QM2010 is unlocked.

2. Part Number

The part number for the USB Stick Synthesizer is in the format *QM2010-XX-YY*, where *XX* is the lower operating frequency limit in MHz or GHz and *YY* is the upper operating frequency limit in MHz or GHz. For example, *QM2010-5-10* identifies the USB Stick Synthesizer as having an operating range of 5 GHz to 10 GHz. Lower frequency synthesizers, that accept MHz arguments for frequency parameters, may only list the upper frequency limit. This is true with the *QM2010-4400*, which operates from 35 MHz to 4400 MHz, and the *QM2010-6000*, which operates from 25 MHz to 6000 MHz.



2 Remote Operation

In This Chapter

1.	Introduction	6
1.1	USB Configuration	6
1.2	Command Syntax	6
1.2.1	Mnemonic Forms	6
1.2.2	Using a Semicolon(;)	6
1.2.3	Using Whitespace	6
1.2.4	Using "?" Commands	6
1.2.5	Using "*" Commands	6
1.3	Diagram Syntax Conventions	6
1.4	Default Units	7
1.5	Status Reporting	7
1.6	SCPI Data Types	7
1.6.1	<boolean> Definition	7
1.6.2	<character_data> Definition	8
1.6.3	<NAN> Definition	8
1.6.4	<non-decimal numeric> Definition	8
1.6.5	<NRf> Definition	8
1.6.6	<NR1> Definition	8
1.6.7	<NR2> Definition	8
1.6.8	<NR3> Definition	9
1.6.9	<numeric_value> Definition	9
1.6.10	<string> Definition	9
1.7	Input Message Terminators	10
1.8	Compliance Information	10
1.8.1	IEEE-488.2 Compliance	10
1.8.2	SCPI Compliance	10

1.8.3 USBTMC Compliance 11

1.8.4 VISA Compliance 11

The following markings apply to the QM2010 USB Stick Synthesizer family of products.

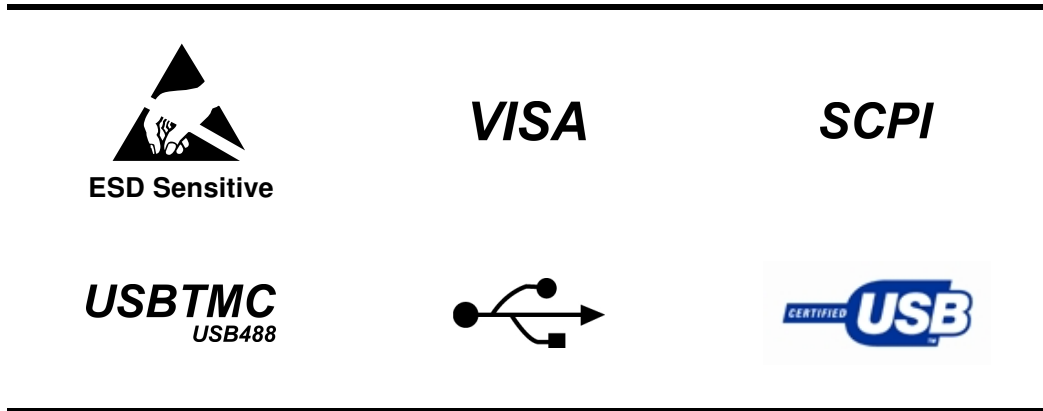

1. Introduction

1.1 USB Configuration

The Quonset Microwave QM2010 USB Stick Synthesizer has been designed to configure as a USB Test and Measurement Class (USBTMC) device. No additional drivers are required.

The QM2010 has been designed to be Virtual Instrument Software Architecture (VISA) and Standard Commands for Programmable Instrumentation (SCPI) compliant and as such, all you need in order to communicate with the USB Stick Synthesizer is a VISA library installed on your machine. The QM2010 has been designed using the NI-VISA Runtime Engine, which is included with the GUI.

1.2 Command Syntax

In this manual, the following command syntax conventions are used:

- Square brackets ([]) indicate multiple keywords, one of which must be used
- Bars(|) can be read as "or" and are used to separate parameter options.

1.2.1 Mnemonic Forms

Each keyword has both a long and short form. A standard notation is used to differentiate the short form and long form keyword. The long form of the keyword is shown, with the short form of the keyword shown in uppercase letters and the rest of the keyword is shown in lowercase letters. For example, the short form of *FREQuency* is *FREQ*.

1.2.2 Using a Semicolon(;)

Use a semicolon to separate two commands within the same command string.

1.2.3 Using Whitespace

You *must* use whitespace characters, [tab], or [space] to separate a parameter from a keyword.

1.2.4 Using "?" Commands

The bus controller may send commands at any time, but a SCPI instrument may only send a response when specifically instructed to do so. Only commands that end with a "?", henceforth referred to as queries, instruct the instrument to send a response message. Queries can return either measured values, instrument settings, or internal status codes.

Note: *If you send multiple queries without reading the response between queries, only the result of the last query will be returned when the response is read. The query buffer is a first-in first-out configuration.*

1.2.5 Using "*" Commands

Commands starting with a "*" are called common commands. They are required to perform identical functions for all instruments that are compliant with the IEEE-488.2 interface standard. The "*" commands are used to control reset, self-test, and status operations in the USB Stick Synthesizer.

1.3 Diagram Syntax Conventions

- Solid lines represent the recommended path
- Ovals enclose command mnemonics. The command mnemonic must be entered exactly as shown in the oval.
- Dotted lines indicate an optional path for passing secondary or optional keywords.

- Arrows and curved intersections indicate command path direction.
- All diagrams flow from left to right. A path may not travel to the left except in a bypass loop.

1.4 Default Units

Unless otherwise specified, the following units are assumed:

Table 2.2: Default Units

Current	mA
Frequency	GHz
Power	dBm
Time	ms
Temperature	°C
Voltage	Volts

1.5 Status Reporting

Status reporting is used to monitor the USB Stick Synthesizer to determine which events have occurred. Status reporting is accomplished by configuring and reading status registers.

The USB Stick Synthesizer has the following main registers:

- Status Register
- Standard Event Register
- Operation Status Register
- Questionable Status Register
- Device Status Register

Status and Standard Event registers are read using the IEEE-488.2 common commands.

Operation and Questionable Status registers are read using the SCPI *STAT* subsystem.

1.6 SCPI Data Types

The SCPI language defines different formats for use in program messages and response messages. Instruments are flexible listeners and can accept commands and parameters in various formats. However, SCPI instruments are precise talkers. This means that SCPI instruments *always* responds to a particular query in a predefined, rigid format.

1.6.1 <boolean> Definition

Throughout this document <*boolean*> is used to represent *ON|OFF* <*NRf*>. Boolean parameters have a value of *0* or *1* and are unitless. *ON* corresponds to *1* and *OFF* corresponds to *0*.

On input, an <*NRf*> is rounded to an integer. A nonzero result is interpreted as *1*.

Queries always return a *1* or a *0*, never *ON* or *OFF*.

1.6.2 <character_data> Definition

Throughout this document, <character_data> is used to represent character data, that is, A-Z, a-z, 0-9 and _ (underscore). STOP and A4_U2 are examples of character data. The first character must be alphanumeric, followed by either alphanumeric or underscore characters up to a maximum of 12 characters.

1.6.3 <NAN> Definition

Not a number (NAN) is represented as 9.91 E37. Not a number is defined in IEEE 754.

1.6.4 <non-decimal numeric> Definition

Throughout this document, <non-decimal numeric> is used to represent numeric information in bases other than 10 (that is, hexadecimal, octal, and binary). Examples of non-decimal numeric include #HFF4, #hff4, #Q25, #q25, and #B101011.

1.6.5 <NRf> Definition

Throughout this document, <NRf> is used to denote a flexible numeric representation. The following show examples of <NRf>

- +185
- -10
- +1.2E09

1.6.6 <NR1> Definition

Throughout this document, <NR1> numeric response data is defined as:

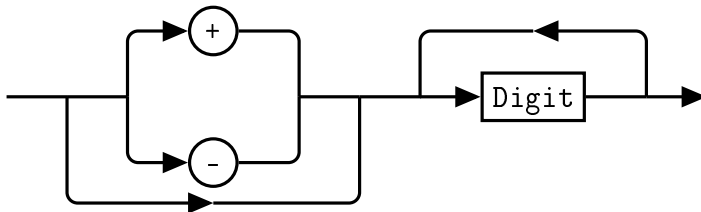

The following shows the examples of <NR1>:

- 127
- +127
- -12345

1.6.7 <NR2> Definition

Throughout this document, <NR2> numeric response data is defined as:

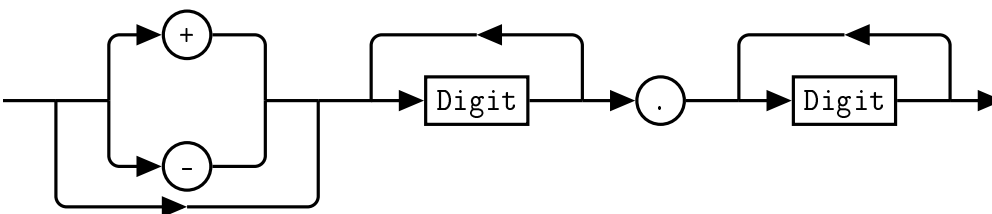

The following shows the examples of <NR2>:

- 12.7
- +127
- -1.2345
- -0.123

1.6.8 <NR3> Definition

Throughout this document, <NR3> numeric response data is defined as:

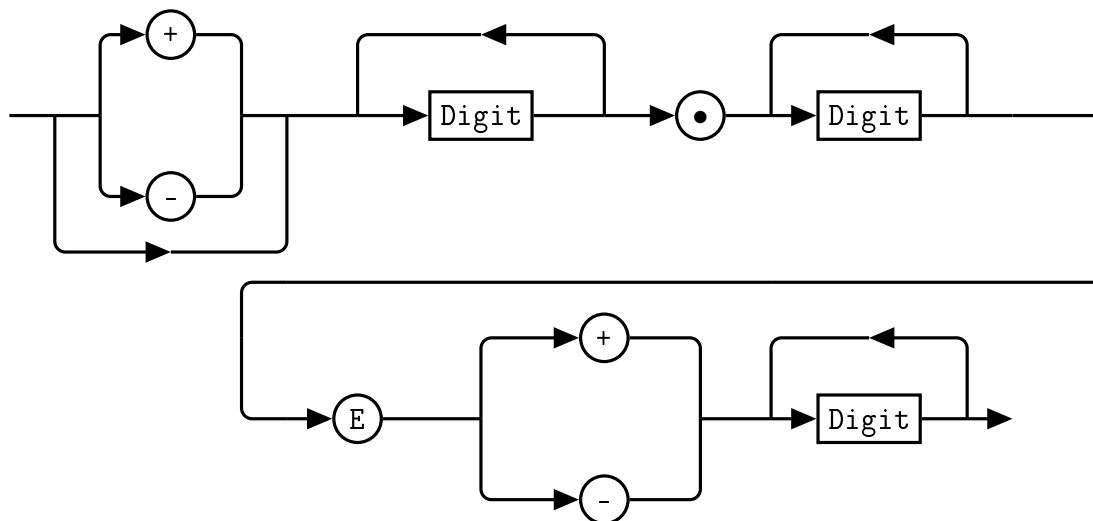

The following shows the examples of <NR3>:

- 1.23E+4
- 12.3E-45

1.6.9 <numeric_value> Definition

Throughout this document, the decimal numeric element is abbreviated to <numeric_value>.

1.6.10 <string> Definition

Throughout this document, <string> is used to represent the 7-bit ASCII characters. The format is defined as:

Program Data

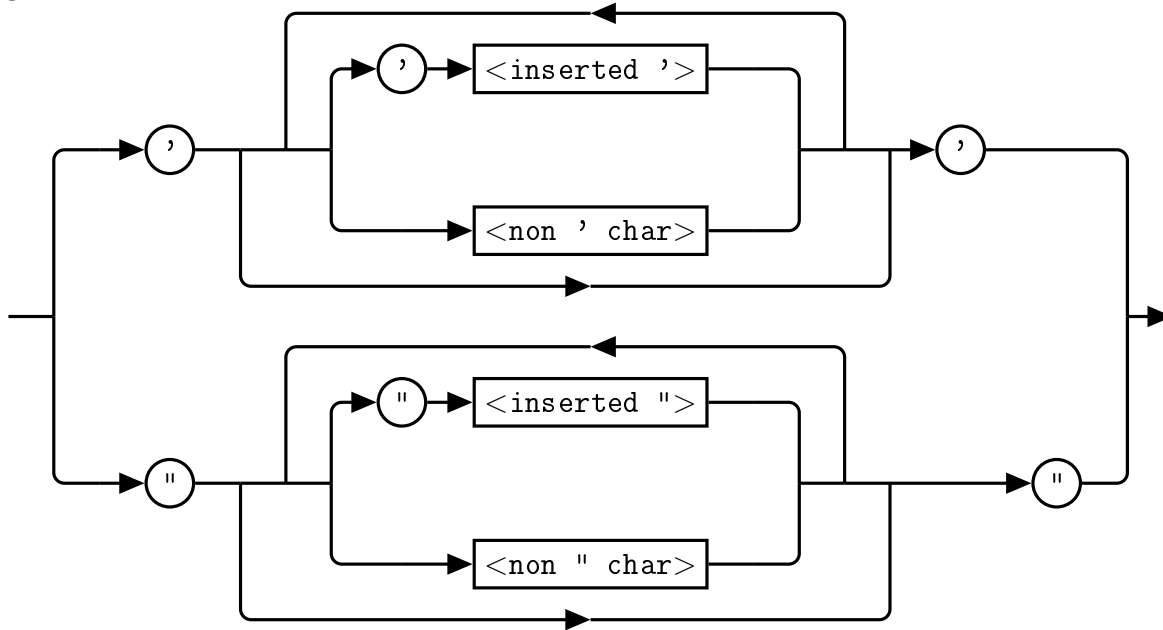

Response Data

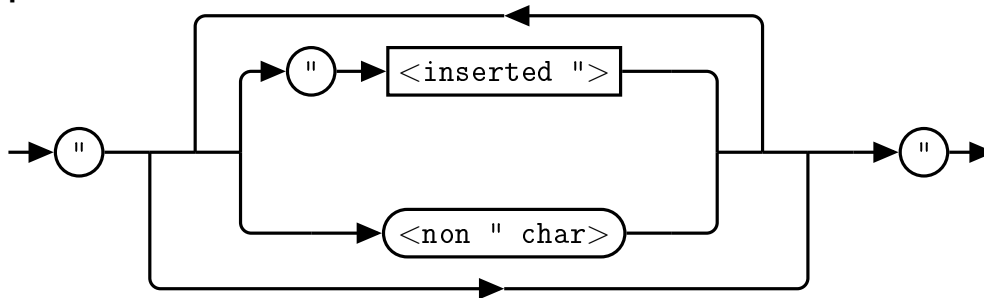

1.7 Input Message Terminators

Program messages sent to a SCPI instrument *must* terminate with a <newline> character. The IEEE.488 EOI (end or identify) signal is interpreted as a <newline> character and may also be used to terminate a message in place of the <newline> character. A <carriage return> followed by a <newline> character is also accepted. Many programming languages allow you to specify a message terminator character or EOI state to be automatically sent with each bus transaction. Message termination *always* sets the current path back to the root-level.

1.8 Compliance Information

1.8.1 IEEE-488.2 Compliance

The USB Stick Synthesizer complies with the rules and regulations of the of the IEEE-488.2 standard which are applicable to USB controlled devices.

1.8.2 SCPI Compliance

The USB Stick Synthesizer complies with the rules and regulations of the of the SCPI (Standard Commands for Programmable Instruments). You can determine the SCPI version which the USB Stick Synthesizer complies with by sending the *SYSTem:VERsion?* command from the remote interface.

1.8.3 USBTMC Compliance

The QM2010 USB Stick Synthesizer complies with the rules and regulations of the of the USBTMC (USB Test and Measurement Class). When connected to a USB bus, the QM2010 will configure as a USB Test and Measurement device.

1.8.4 VISA Compliance

The QM2010 USB Stick Synthesizer complies with the rules and regulations of the of the VISA (Virtual Instrument Systems Architecture) standard. Communication with the QM2010 is accomplished through VISA libraries, providing portability between different operating systems. *No additional drivers are required.*



3 Command Quick Reference Guide

In This Chapter

1. Common (*) Commands	13
2. FREQUENCY Subsystem	14
3. POWER Subsystem	14
4. SYSTEM Subsystem	14

1. Common (*) Commands

Table 3.1: Common (*) Commands Summary

Command	Page	Description
*CLS	44	Clears the data structures. The SCPI registers are cleared.
*ESE <NRf>	45	Sets the Standard Event Status Enable Register.
*ESE?	45	Returns the Standard Event Status Enable Register.
*ESR?	46	Returns the contents of the Standard Event Status Register and then clears it.
*IDN?	47	Returns the identification of the device connected to the computer (Host).
*OPC	48	Causes the USB Stick Synthesizer to set the operation complete bit in the Standard Event Status Register when all pending operations have completed.
*OPC?	48	Returns the operation complete bit in the Standard Event Status Register when all pending operations have completed.
*OPT?	49	Returns the USB Stick Synthesizer installed options.
*RCL <NRf>	50	Recalls the state of the USB Stick Synthesizer from the specified register (memory location).
*RST	51	Returns the USB Stick Synthesizer to its initial power up state.
*SAV <NRf>	52	Saves the state of the USB Stick Synthesizer to the specified register (memory location).
*SRE <NRf>	53	Sets the Service Request Enable register bits.
*SRE?	53	Returns the Service Request Enable register bits.
*STB?	54	Returns the USB Stick Synthesizer status byte.
*TRG	56	Triggers the USB Stick Synthesizer.
*TST?	57	Performs a self test of the USB Stick Synthesizer.
*WAI	58	Causes the USB Stick Synthesizer to wait until either all pending commands are complete, the Device Clear command is received, or the power is cycled before executing any subsequent commands or queries.
DCL	59	Causes all USB instruments to assume a cleared condition.

2. FREQuency Subsystem

Table 3.2: FREQuency subsystem Commands Summary

Command	Page	Description
FREQuency:LOCK	17	Returns the lock status of the device.
FREQuency:PLLMode	18	Sets or Returns the PLL Mode of the device to <i>Integer</i> or <i>Fractional</i> .
FREQuency:REFerence:DIVider	20	Sets or Returns the reference divider value for the PLL of the device.
FREQuency:REFerence:EXTernal	21	Sets or Returns whether the internal or external supplied reference oscillator is used.
FREQuency:REFerence:FREQuency	22	Sets or Returns the reference frequency in MHz. When using the internal reference, this should always be 50 MHz.
FREQuency:RETreiveACTual	23	Returns the actual frequency of the device in GHz (or MHz, depending on the USB Stick Synthesizer series). This query is useful when internal frequency rounding occurs in integer mode.
FREQuency:SET	24	Sets or Returns the desired tuning frequency in GHz (or MHz, depending on the USB Stick Synthesizer series).

3. POWEr Subsystem

Table 3.3: POWEr subsystem Commands Summary

Command	Page	Description
POWEr:RF	26	Turns on or off the RF output of the device.
POWEr:SET	27	Sets or Returns the output power of the device.

4. SYSTem Subsystem

Table 3.4: SYSTem subsystem Commands Summary

Command	Page	Description
SYSTem:ERRor	29	Returns the contents of the error queue of the device.
SYSTem:SERialNUMber	34	Returns the serial number of the device.
SYSTem:STATus	35	Returns the status of the device.
SYSTem:TEMPerature	36	Returns the current temperature reading from the device (GHz models only).

SYSTem:VERSion	37	Returns the version of SCPI used by the device.
SYSTem:SAVESTATE	38	Saves the current parameters to a specified state number.
SYSTem:LOADSTATE	39	Loads and sets the parameters from the specified state.
SYSTem:BOOTSTATE	40	Specifies a state to boot to at device startup.
SYSTem:READSTATE	41	Reads the parameters from the stored states without changing the current device setup.
SYSTem:FIRMware	33	Returns the current firmware version of the device.



4 FREQUENCY Subsystem

In This Chapter

1. FREQUENCY:LOCK	17
2. FREQUENCY:PLLMode	18
3. FREQUENCY:REFerence:DIVider	20
4. FREQUENCY:REFerence:EXTernal	21
5. FREQUENCY:REFerence:FREQUENCY	22
6. FREQUENCY:RETriveACTual	23
7. FREQUENCY:SET	24

1. FREQuency:LOCK?

This command returns the lock status of the USB Stick Synthesizer. A lock status of *0* indicates that the device is unlocked, while a lock status of *1* indicates that the device is locked.

Syntax



Query Example

FREQ:LOCK? *This query returns the lock status of the device*

2. FREQuency:PLLMode [INT|FRAC|1|0]

This command sets the Phase Lock Loop (PLL) mode of the USB Stick Synthesizer. A PLL mode of *INT* or *1* indicates that the PLL is operating in Integer mode, while a PLL mode of *FRAC* or *0* indicates that the PLL is operating in Fractional Mode.

When the PLL is placed in *Integer* mode (also referred to as *Integer-N* mode), the output frequency is an integer multiple of the reference oscillator frequency divided by the reference divider. For example, if the reference frequency is 20 MHz, and the reference divider is 2, then when placed in *Integer* mode, the synthesizer would be capable of outputting a frequency of 9.0 GHz and 9.010 GHz, but not a frequency of 9.005 GHz (10 MHz tuning resolution). If there reference is 10 MHz and the reference divider is 1, the same would situation would apply.

When the PLL is placed in *Fractional* mode, the output frequency can be any non-integer multiple of the reference oscillator frequency. In the above example, the synthesizer would be capable of outputting a frequency of 9.005 GHz when operated in *Fractional* mode.

Table 4.1 summarizes the advantages and disadvantages of the two synthesizer operational modes.

Table 4.1: Comparison between Integer and Fractional PLL modes

Mode	Advantages	Disadvantages
Integer	Lower Phase Noise Phase Synchronization between modules is guaranteed	Frequency must be an integer multiple of the reference frequency
Fractional	Any frequency can be outputted	Increased Phase Noise Phase synchronization is difficult to achieve at best

Syntax

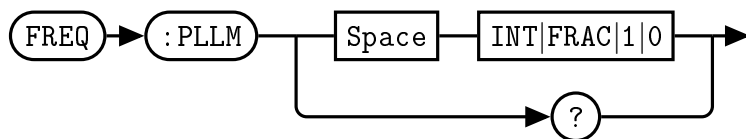

Example

FREQ:PLLM 1 *This command sets the PLL mode of the device to Integer mode.*

Default Condition

On power up, or when a **RST* command is issued, the PLL mode setting returns to the default.

Query Example

FREQ:PLLM? *This query returns the PLL mode of the device.*

- 0 is returned if the synthesizer is Fractional Mode
- 1 is returned if the synthesizer is in Integer Mode

3. FREQuency:REFerence:DIVider <numeric value>

This command allows the user to set the frequency reference divider of the USB Stick Synthesizer. The reference frequency divider is used to provide finer resolution steps in integer mode. The acceptable range for the reference divider is 1 through 127. The fundamental frequency step size in integer mode is $\frac{f_{ref}}{N}$, where N is the value of the reference divider.

Note: Phase noise will degrade as the REFDIV value increases.

Syntax

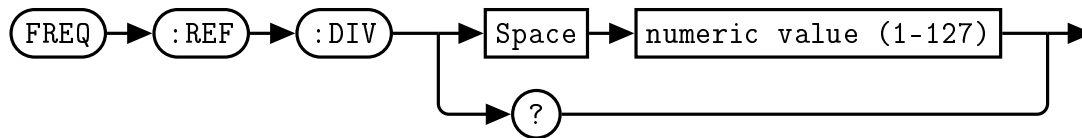

Allowed Values

The reference frequency divider value can be set to any integer value between 1 and 127.

Example

FREQ:REF:DIV 10 *This command sets the reference divider value to 10.*

Default Condition

On power up, or when a *RST command is issued, the reference divider value returns to the default.

Query

FREQ:REF:DIV? *This query returns the reference divider value*

4. FREQuency:REFerence:EXTernal [ON|OFF|1|0]

This command allows the user to select between the internal 20 MHz reference and an externally supplied reference. Note that when an external reference is applied, the appropriate reference frequency and reference divider values must be set. When switching from an external reference to the internal reference, the reference frequency value will automatically be set to 20 MHz.

When *OFF* or *0* is specified, the internal reference oscillator is used by the USB Stick Synthesizer.

When *ON* or *1* is specified, the external reference input is used by the USB Stick Synthesizer.

Syntax

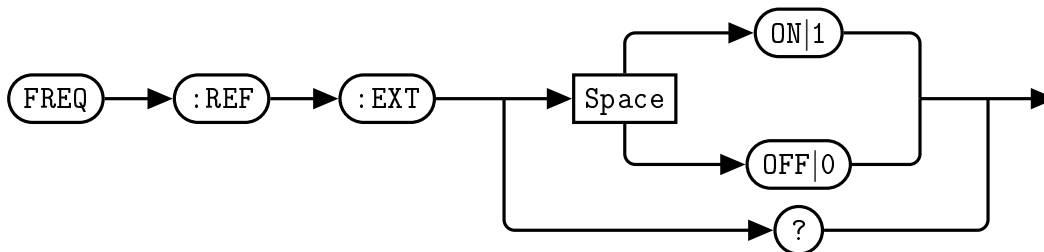

Example

FREQ:REF:EXT 0 *This command selects the internal reference oscillator.*

Default Condition

On power up, or when a **RST* command is issued, the USB Stick Synthesizer returns to the default state.

Query

FREQ:REF:EXT? *This query returns a 0 or 1 to indicate the selected USB Stick Synthesizer reference mode*

- 0 is returned if the internal reference is selected
- 1 is returned if the external reference oscillator is selected

5. FREQuency:REFeRence:FREQuency <numeric value>

This command allows the user to set the synthesizer reference oscillator frequency in MHz. The allowed values are between 10 MHz and 100 MHz. The default value is 50 MHz.

Syntax

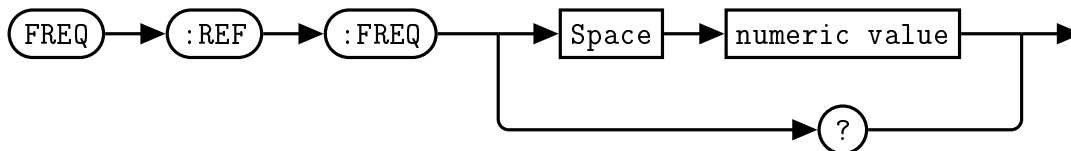

Allowed Values

The reference frequency can be set to any integer value between 10 and 100.

Example

FREQ:REF:FREQ 10 *This command sets the internal reference oscillator to 10 MHz*

Default Condition

On power up, or when a *RST command is issued, the synthesizer reference oscillator frequency defaults to 50 MHz.

Query

FREQ:REF:FREQ? *This query returns the synthesizer reference frequency in MHz.*

6. FREQuency:RETreiveACTual?

This command returns the actual tuned frequency in GHz (or MHz, depending on the series of USB Stick Synthesizer). When in integer mode, the USB Stick Synthesizer is capable of only tuning in discrete steps, and therefore the actual tuned frequency may vary slightly from the desired frequency set using the *FREQ:SET* command.

Syntax



Query Example

FREQ:RETACT? *This query returns the actual tuned frequency in GHz (or MHz, depending on the USB Stick Synthesizer series).*

7. FREQuency:SET <numeric value>

This command allows the user to set the frequency of the USB Stick Synthesizer. The frequency value is specified in GHz.

Syntax

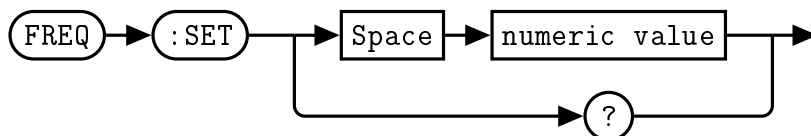

Example

FREQ:SET 5.5 *This command sets the tuning frequency of the device to 5.5 GHz*

Default Condition

On power up, or when a *RST command is issued, the synthesizer frequency returns to the default frequency.

Query

FREQ:SET? *This query returns the frequency for the device in GHz.*

Error Messages

If the frequency entered is out of the operational range of the device, an error message of 201, "Parameter specified out of Device operating range" is placed in the device's error queue.



5 POWER Subsystem

In This Chapter

1. POWER:RF	26
2. POWER:SET	27

1. POWER:RF [ON|OFF|1|0]

This command allows the user to turn on and off the RF output of the USB Stick Synthesizer.

Syntax

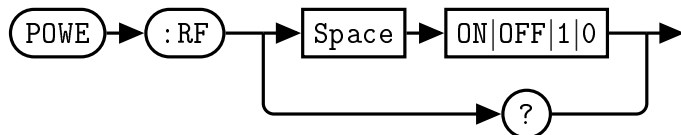

Example

POWE:RF 0 *This command turns off the RF.*

Default Condition

On power up, or when a *SYST:PRES* or **RST* command is issued, the USB Stick Synthesizer RF output defaults to the *RF OFF* state, unless otherwise specified in the product's Operation Manual.

Query

POWE:RF? *This query returns power output state of the device.*

- 0 is returned if the RF output is *OFF*
- 1 is returned if the RF output is *ON*

Error Messages

If the device does not have an integrated mute capability, an error message of 110, "*Invalid Command For Specified Device*" is placed in the device's error queue.

2. POWER:SET [numeric value|MIN|MAX]

This command allows the user to set the output power of the QM2010 to a specified numeric value, the minimum output power level, or the maximum output power level. The range of acceptable input power values is dependent on frequency. If a specified input value cannot be reached, the QM2010 will automatically set the power level to the next closest value. Power settings stay static across frequency changes; therefore, if the power level is set to 5 dBm at 6 GHz, changing the frequency to 8 GHz will automatically set the power level to 5 dBm. The same is true when the maximum or minimum value is set, but note that the maximum output power at 5 GHz may be different from the maximum output power at 9 GHz.

Syntax

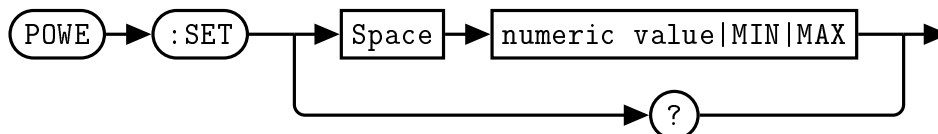

Example

POWE:SET MAX *This command sets the output power of the device to its maximum value*

POWE:SET -10 *This command sets the output power of the device to -10 dBm*

Default Condition

On power up, or when a *RST command is issued, the QM2010 output power returns to the default power level.

Query

POWE:SET? -5 *(The output power of the device is currently -5 dBm. Neither MAX nor MIN has been specified.)*

POWE:SET? MAX,15 *(MAX has been specified, and the maximum output power at the current frequency is 15 dBm. The two values are separated by a comma.)*

Error Messages

If the power entered is out of the operational range of the device, an error message of 201, "Parameter specified out of Device's operating range" is placed in the device's error queue.



6 SYSTem Subsystem

In This Chapter

1. SYSTem:ERRor	29
2. SYSTem:FIRMware	33
3. SYSTem:SERialNUMber	34
4. SYSTem:STATus	35
5. SYSTem:TEMPerature	36
6. SYSTem:VERSion	37
7. SYSTem:SAVESTATE	38
8. SYSTem:LOADSTATE	39
9. SYSTem:BOOTSTATE	40
10. SYSTem:READSTATE	41

1. SYSTem:ERRor?

This query returns error numbers and messages from the QM2010 error queue. When an error is generated by the QM2010, the error number and corresponding error message is stored in the error queue. Each time the error queue is queried, the first error in the error queue is returned. The errors are read out in the order of first-in first-out. To clear all errors in the error queue, use the *CLS command.

When the error queue is empty, a query of the error queue will return a 0, "No error" message. The error queue has a maximum capacity of 10 errors.

Syntax

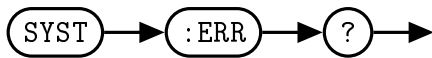

Query Example

SYST:ERR? *Queries the system error.*

Error queue messages have the following format:



For example, 100, "Syntax Error"

Reset Condition

On reset, the error queue is cleared.

Error Message List

Table 6.1: Error Codes and Messages

-101	Invalid character Invalid character was found in the command string.
-102	Syntax error Invalid syntax was found in the command string.
-103	Invalid separator Invalid separator was found in the command string.
-105	GET not allowed A Group Execute Trigger (GET) is not allowed within a command string.
-108	Parameter not allowed More parameters were received than expected for the command.
-109	Missing parameter Fewer parameters were received than expected for the command.
-112	Program mnemonic too long A command header was received which contained more than the maximum 12 characters allowed.

-113	Undefined header A command was received that is not valid for the USB Stick Synthesizer.
-121	Invalid character in number An invalid character was found in the number specified for a parameter value.
-123	Exponent too large A numeric parameter was found whose exponent was larger than 32,000.
-124	Too many digits A numeric parameter was found whose mantissa contained more than 255 digits.
-128	Numeric data not allowed A numeric value was received within a command which does not accept a numeric value.
-131	Invalid suffix A unit was incorrectly specified for a numeric parameter.
-134	Suffix too long A unit used contained more than 12 characters.
-138	Suffix not allowed A unit was received following a numeric parameter which does not accept a unit.
-141	Invalid character data An invalid character was received.
-148	Character data not allowed A discrete parameter was received but a character string or numeric parameter was expected.
-151	Invalid string data An invalid string was received.
-158	String data not allowed A character string was received but not allowed for the command.
-161	Invalid block data A block data element was expected but was invalid.
-168	Block data not allowed A legal block data element was encountered but not allowed by the Product.
-178	Expression data not allowed A legal expression data element was encountered but not allowed by the Product.
-200	Execution error Indicates that an execution error has occurred.
-211	Trigger ignored

	Indicates that a trigger command was received but ignored because the USB Stick Synthesizer was not in the wait for trigger state.
-213	Trigger ignored Indicates that a trigger command was received but ignored because the USB Stick Synthesizer was not in the wait for trigger state.
-222	Data out of range A numeric parameter value is outside the valid range for the command.
-224	Illegal parameter value A discrete parameter was received which was not a valid choice for the command.
-230	Data corrupt or stale This occurs when a measurement command is attempted and either a reset has been received or the state of the USB Stick Synthesizer has changed such that the measurement is no longer valid.
-241	Hardware missing The USB Stick Synthesizer is unable to execute the command because the hardware does not support that feature.
-310	System error This error indicates a failure with the USB Stick Synthesizer.
-330	Self-test failed The -330, "Self-test failed" error indicates a problem with the USB Stick Synthesizer.
-350	Queue overflow The error queue is full and another error has occurred which could not be recorded.
-410	Query INTERRUPTED A command was received which sends data to the output buffer, but the output buffer contained data from a previous command. The output buffer is cleared when power has been off or after a *RST command has been issued.
-420	Query UNTERMINATED The USB Stick Synthesizer was addressed to talk but a command has not been received which sends data to the output buffer.
-430	Query DEADLOCKED A command was received which generates too much data to fit in the output buffer and the input buffer is also full. Command execution continues but data is lost.
-440	Query UNTERMINATED after indefinite response The *IDN? command must be the last query command within a command string.
+0	No error No errors in the error queue. Device is operating normally.

+110 Invalid Command For Specified Device
The issued command is invalid for the specified device.

2. SYSTem:FIRMware?

This command returns the current firmware version of the QM2010.

Syntax

Syntax



Query Example

SYST:FIRM? *This query returns the current firmware version of the USB Stick Synthesizer.*

3. SYSTem:SERialNUMBER?

This command returns the serial number of the device.

Syntax



Query Example

SYST:SERNUM? *This query returns the serial number of the device.*

4. SYSTem:STATus?

This command returns the status of the USB Stick Synthesizer.

Syntax



Query Example

SYST:STAT? *This query returns the status of the USB Stick Synthesizer.*

Status messages have the following format:



For example, 0, "Operational"

Status Message List

Table 6.2: Status Codes and Messages

0	Operational Device is operating normally
1	Device Has Been Reset The device has been recently reset
2	Awaiting User Input Unit is awaiting user input.
100	Recoverable Error Has Occurred An error has occurred from which the device can recover.
101	Non-Recoverable Error Has Occurred An error has occurred from which the device can not recover.

5. SYSTem:TEMPerature?

This command returns the maximum temperature reading from the QM2010 in Celsius.

NOTICE

The **SYST:TEMP** command is currently only available on GHz models. It is not currently available on MHz models.

Syntax



Query Example

SYST:TEMP? *This query returns the current temperature reading from the USB Stick Synthesizer.*

6. SYSTem:VERSion?

This query returns the version of SCPI used in the USB Stick Synthesizer. The response is in the format XXXX.Y, where XXXX is the year and Y is the version number.

Syntax



Query Example

SYST:VERS? *This query returns the version of SCPI used in the USB Stick Synthesizer.*

7. SYSTem:SAVESTATE [1-5]

This command saves the current setup to non-volatile memory. There are 5 re-writeable memory locations, specified by choosing an index between 1 and 5. Any of the 5 states can be restored on startup when specified with the SYSTem:BOOTSTATE command. The parameters saved are the *PLL mode, frequency, reference divider, reference internal/external, reference frequency, max/min power setting, output power, RF power*. For a detailed description of the parameters saved, see your product's *Operation Manual*.

NOTICE

The **SYST:SAVESTATE** command is only available on synthesizers with firmware versions 4.0.0 and higher.

Syntax

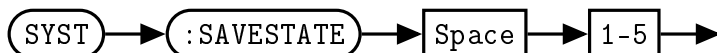

There are 5 memory locations, numbered 1 through 5. Memory location 0 contains the factory default settings and is write-protected.

Example

SYST:SAVESTATE 3 *This command saves the current state to memory location 3*

8. SYSTem:LOADSTATE [0-5]

This command restores a previously saved state from non-volatile memory. In addition to factory default state 0, there are 5 re-writeable memory locations, specified by choosing an index between 1 and 5. The restored parameters are the *PLL mode, frequency, reference divider, reference internal/external, reference frequency, max/min power setting, output power, RF power*. When the *LOADSTATE* command is called, these parameters will be applied to the device.

NOTICE

The **SYST:LOADSTATE** command is only available on synthesizers with firmware versions 4.0.0 and higher.

Syntax

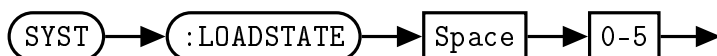

There are 6 memory locations, numbered 0 through 5. Memory location 0 contains the factory default settings, while locations 1-5 are user re-writeable using SYSTem:SAVESTATE.

Example

SYST:LOADSTATE 4 *This command loads the state 4 parameters from non-volatile memory and applies them to the device.*

9. SYSTem:BOOTSTATE [0-5]

This command specifies a previously saved state to be loaded upon device startup. In addition to factory default state 0, there are 5 re-writeable memory locations. Any of these 6 boot states can be selected by choosing an index between 0 and 5. The restored parameters are the *PLL mode, frequency, reference divider, reference internal/external, reference frequency, max/min power setting, output power, RF power*.

NOTICE

The **SYST:BOOTSTATE** command is only available on synthesizers with firmware versions 4.0.0 and higher.

Syntax

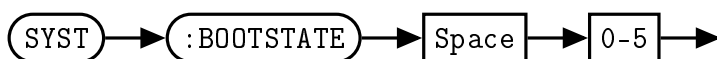

There are 6 memory locations, numbered 0 through 5. Memory location 0 contains the factory default settings, while locations 1-5 are user re-writeable using SYSTem:BOOTSTATE.

Example

SYST:BOOTSTATE 1 *This command specifies state 1 to be loaded upon device powerup.*

Default Condition

The factory default setting for SYST:BOOTSTATE is 0.

10. SYST:READSTATE?

The READSTATE query allows the user to read the parameters of the stored states without changing any internal registers. The query output is a list of parameters for each state with each state separated by semi-colons. Each list of state parameters contains comma separated values, without spaces, in the following order: *PLL mode, frequency, reference divider, reference internal/external, reference frequency, max/min power setting, output power, RF power*. See the respective command definitions for descriptions of each parameter.

NOTICE

The **SYST:READSTATE** query is only available on synthesizers with firmware versions 4.0.0 and higher.

Syntax

SYST → **:READSTATE?**

Query

SYST:READSTATE? *This query requests the parameter values of states 0-5.*

Response: *1,8.000,2,0,20,OFF,0,1,1*

- 1 = FREQUENCY:PLLMODE is set to integer (page 18)
- 8.000 = FREQUENCY:SET is set to 8 GHz (page 24)
- 2 = FREQUENCY:REFERENCE:DIVIDER is set to 2 (page 20)
- 0 = FREQUENCY:REFERENCE:EXTERNAL is set to internal (page 21)
- 20 = FREQUENCY:REFERENCE:FREQUENCY is set to 20 MHz (page 22)
- OFF = The string "OFF" denotes that neither "MAX" nor "MIN" has been specified as the output power via the POWER:SET command
- 0 = POWER:SET is set to 0 dBm (page 27)
- 1 = POWER:RF is set to 1 or ON. (page 26).

Error Messages

If the device does not have an integrated mute capability, an error message of 110, *"Invalid Command For Specified Device"* is placed in the device's error queue.



7 IEEE 488.2 Command Reference

In This Chapter

1. SCPI Compliance Information	43
2. *CLS	44
3. *ESE <NRf>	45
4. *ESR?	46
5. *IDN?	47
6. *OPC	48
7. *OPT?	49
8. *RCL <NRf>	50
9. *RST	51
10. *SAV <NRf>	52
11. *SRE <NRf>	53
12. *STB?	54
13. *TRG	56
14. *TST?	57
15. *WAI	58
16. USBTMC/USB488 Universal Commands	59

1. SCPI Compliance Information

This chapter contains information on the IEEE-488 Common Commands that the USB Stick Synthesizer supports.

The IEEE-488.2 Common Command descriptions are listed below.

Table 7.1: IEEE 488.2 Common commands

<i>*CLS</i>	Clear Status	Page 44
<i>*ESE</i> and <i>*ESE?</i>	Event Status Enable	Page 45
<i>*ESR?</i>	Event Status Register	Page 46
<i>*IDN?</i>	Identify	Page 47
<i>*OPC</i> and <i>*OPC?</i>	Operation Complete	Page 48
<i>*OPT?</i>	Options	Page 49
<i>*RCL</i>	Recall	Page 50
<i>*RST</i>	Reset	Page 51
<i>*SAV</i>	Save	Page 52
<i>*SRE</i> and <i>*SRE?</i>	Service Request Enable	Page 53
<i>*STB?</i>	Status Byte	Page 54
<i>*TRG</i>	Trigger	Page 56
<i>*TST?</i>	Test	Page 57
<i>*WAI</i>	Wait	Page 58

2. *CLS

The *CLS (CLear Status) command clears the data structures. The SCPI registers are all cleared.

Syntax

*CLS →

3. *ESE <NRf>

The *ESE (Event Status Enable) command sets the Standard Event Status Enable Register. This register contains a mask value for the bits to be enabled in the Standard Event Status Register. A 1 in the enable register enables the corresponding bit in the Status Register, a 0 disables the corresponding bit in the Status Register. The parameter value when expressed in base 2, represents the bit values of the Standard Event Status Enable Register. Table 7.2 shows the contents of this register.

Table 7.2: *ESE bit mapping

Bit	Base 2	Meaning
0	1	Operation Complete
1	2	Request Control (not used)
2	4	Query Error
3	8	Device Dependent Error
4	16	Execution Error
5	32	Command Error
6	64	Not Used
7	128	Power On

Syntax

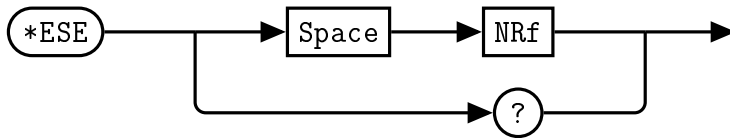

Allowed Values

The NRf parameter can be any integer in the range of 0 to 255.

Query

*ESE? *This query returns the contents of the Standard Event Status Enable Register.*

4. *ESR?

The *ESR? query returns the contents of the Standard Event Status Register then clears it. The returned value is in the range of 0 to 255. Table 7.3 shows the contents of this register.

Table 7.3: *ESR? mapping

Bit	Base 2	Meaning
0	1	Operation Complete
1	2	Not Used
2	4	Query Error
3	8	Device Dependent Error
4	16	Execution Error
5	32	Command Error
6	64	Not Used
7	128	Power On

Syntax

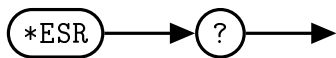

5. *IDN?

The **IDN?* query allows the connected device to identify itself. The string returned is:

Quonset Microwave,<Product Number>,<Serial Number>,<Firmware>

where:

- *<Product Number>* identifies the product number of the host
- *<Serial Number>* uniquely identifies the host
- *<Firmware>* returns the firmware of the host

Syntax

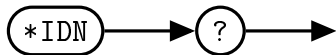

6. *OPC

The *OPC (Operation Complete) command causes the QM2010 USB Stick Synthesizer to set the operation complete bit in the Standard Event Status Register when all pending device operations have been completed.

Table 7.4: *OPC mapping

Bit	Base 2	Meaning
0	1	Operation Complete
1	2	Not Used
2	4	Query Error
3	8	Device Dependent Error
4	16	Execution Error
5	32	Command Error
6	64	Not Used
7	128	Power On

Syntax

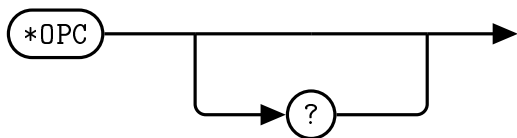

Query

*OPC? *This query places a 1 in the output queue when all device operations have been completed.*

7. *OPT?

The **OPT?* query reports the options installed in the QM2010 USB Stick Synthesizer and returns " " empty string if no options have been installed.

Syntax

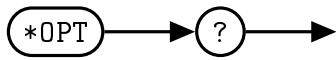

8. *RCL <NRf>

The *RCL (ReCaLI) command restores the state of the QM2010 USB Stick Synthesizer from the specified save or recall register. Valid register addresses are 0 to 9. A configuration must have been stored previously in the specified register.

Syntax

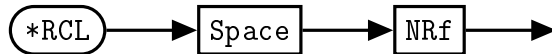

Allowed Values

The *NRf* parameter can be any integer in the range of 0 to 9.

Error Message

If the register does not contain a saved state, error 115, "*Illegal parameter value*" occurs.

9. *RST

The **RST* (ReSeT) command returns the QM2010 USB Stick Synthesizer to its initial power-up state.

Syntax

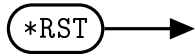
 *RST →

10. *SAV <NRf>

The *SAV (SAVe) command restores the state of the QM2010 USB Stick Synthesizer from the specified save or recall register. Valid register addresses are 0 to 9. A configuration must have been stored previously in the specified register.

Syntax



Allowed Values

The *NRf* parameter can be any integer in the range of 0 to 9.

11. *SRE <NRf>

The *SRE command sets the Service Request Enable register bits. This register contains a mask value for the bits to be enabled in the Status Byte Register. A 1 in the enable register enables the corresponding bit in the Status Register, a 0 disables the corresponding bit in the Status Register. The parameter value when expressed in base 2, represents bits 0 to 5 and bit 7 of the Service Request Enable Register. Bit 6 is not used and is always 0. Table 7.5 shows the contents of this register.

Table 7.5: *SRE bit mapping

Bit	Base 2	Meaning
0	1	Not used
1	2	Not Used (not used)
2	4	Device Dependent
3	8	Questionable Status Summary
4	16	Message Available
5	32	Event Status Bit
6	64	Not Used
7	128	Operation Status Summary

Syntax

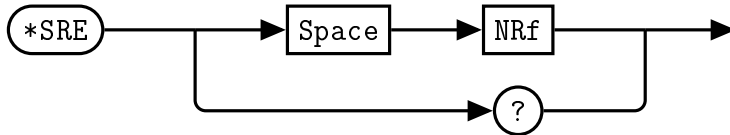

Allowed Values

The NRf parameter can be any integer in the range of 0 to 255.

Query

*SRE? *This query returns the contents of bits 0 to 5 and bit 7 of the Service Request Enable Register. Bit 6 is always 0.*

12. *STB?

The *STB? (STatus Byte) query returns bit 0 to 5 and bit 7 of the QM2010 USB Stick Synthesizer status byte and returns the Master Summary Status (MSS) as bit 6. The MSS is inclusive OR of the bitwise combination (excluding bit 6) of the Status Byte and the Service Request Enable registers. The format of the return is an integer between 0 and 255. Table 7.6 shows the contents of this register.

Table 7.6: *STB? mapping

Bit	Base 2	Meaning
0	1	Not used
1	2	Device Dependent 0 - No device status condition has occurred 1 - A device status condition has occurred
2	4	Error/Event Queue 0 = Queue empty 1 = Queue not empty
3	8	Questionable Status Summary 0 - No QUESTionable status conditions have occurred 1 - A QUESTionable status condition has occurred
4	16	Message Available 0 - no output messages are ready 1 - an output message is ready
5	32	Event Status Bit 0 - no event status has occurred 1 - an event status condition has occurred
6	64	Master Summary Status 0 - USB Stick Synthesizer not requesting service 1 - there is at least one reason for requesting service
7	128	Operation Status Summary 0 = No OPERation status conditions have occurred 1 = An OPERation status condition has occurred

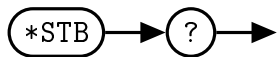
Syntax

13. *TRG

The *TRG (TRiGger) command triggers the QM2010 USB Stick Synthesizer when it is in the waiting for trigger state.

Syntax

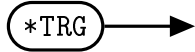
 *TRG →

Error Message

If the USB Stick Synthesizer is not in the wait-for-trigger state, error 210, *"Trigger Ignored"* occurs.

14. *TST?

The **TST?* query causes the QM2010 USB Stick Synthesizer to perform a self-test. The result of the self-test is placed in the output queue.

- 0 is returned if the test passes
- 1 is returned if the test fails

Syntax

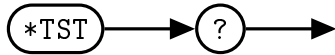

15. *WAI

The **WAI* (WAI) command causes the QM2010 USB Stick Synthesizer to wait until either:

- All pending operations are complete
- The *Device Clear* command is received
- Power is cycled

before executing any subsequent commands or queries.

Syntax

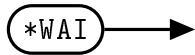
 *WAI →

16. USBTMC/USB488 Universal Commands

DCL

The *DCL* (Device CLear) command causes all USB instruments to assume a cleared condition. The definition of Device Clear is unique for each instrument. For the QM2010 USB Stick Synthesizer:

- All pending operations are halted
- The parser (the software that interprets the programming codes) is reset and is waiting for the first character of a programming code.
- The output buffer is cleared.
- The QM expansion bus is scanned for attached modules. Any modules found on the QM expansion bus are identified.

Index

FREQuency Subsystem

FREQuency:LOCK, 17
 FREQuency:PLLMoDe, 18
 FREQuency:REFeRence:DIVider, 20
 FREQuency:REFeRence:EXTeRnal, 21
 FREQuency:REFeRence:FreQuency, 22
 FREQuency:RETrEiveACTual, 23
 FREQuency:SEt, 24

IEEE 488.2 Commands

*CLS, 44
 *ESE, 45
 *ESR?, 46
 *IDN?, 47
 *OPC, 48
 *OPT?, 49
 *RCL, 50
 *RST, 51
 *SAV, 52
 *SRE, 53
 *STB?, 54
 *TRG, 56
 *TST?, 57
 *WAI, 58

SCPI Compliance Information, 43

POWEr Subsystem

POWEr:RF, 26
 POWEr:SEt, 27

Programing Commands

FREQuency:LOCK, 17
 FREQuency:PLLMoDe, 18
 FREQuency:REFeRence:DIVider, 20
 FREQuency:REFeRence:EXTeRnal, 21
 FREQuency:REFeRence:FreQuency, 22
 FREQuency:RETrEiveACTual, 23
 FREQuency:SEt, 24
 POWEr:RF, 26
 POWEr:SEt, 27
 SYSTem:BOOTSTATE, 40
 SYSTem:ERRor, 29
 SYSTem:FIRMWare, 33

SYSTem:LOADSTATE, 39
 SYSTem:SAVESTATE, 38
 SYSTem:SERialNUMber, 34
 SYSTem:STATus, 35
 SYSTem:TEMPerature, 36
 SYSTem:VERsion, 37
 SYSTory:READSTATE, 41

SYSTem Subsystem

SYSTem:BOOTSTATE, 40
 SYSTem:ERRor, 29
 SYSTem:FIRMWare, 33
 SYSTem:LOADSTATE, 39
 SYSTem:SAVESTATE, 38
 SYSTem:SERialNUMber, 34
 SYSTem:STATus, 35
 SYSTem:TEMPerature, 36
 SYSTem:VERsion, 37

SYSTory Subsystem

SYSTory:READSTATE, 41

USBTMC/USB488 Universal Commands

DCL, 59

Command Quick Reference Guide, 12

Default Units, 7

FREQuency Subsystem, 16

General Safety Information, iv

IEEE 488.2 Command Reference, 42

Introduction, 6

Command Syntax, 6

Mnemonic Forms, 6

Using * Commands, 6

Using ? Commands, 6

Using a Semicolon(;), 6

Using Whitespace, 6

Compliance Information, 10

IEEE-488.2 Compliance, 10

SCPI Compliance, 10

USBTMC Compliance, 11

VISA Compliance, 11

Default Units, 7

Diagram Syntax Conventions, 6

Input Message Terminators, 10

Part Number, 3

SCPI Data Types, 7

Status Reporting, 7

USB, 6

Notices, i

POWER Subsystem, 25

Product Overview, 2

Product Safety, iii

Remote Operation, 4

SYSTEM Subsystem, 28



QM20102010-008-21

Revision 4.0.0, August 2010



Quonset Microwave

Quonset Microwave
www.quonsetmicrowave.com